



SWISS MADE
SWISS TECHNOLOGY

SERIES 520
ADVANCED/STANDARD MODELS



PRECISA DNA: ZERO COMPROMISE

Laboratory and industrial technicians are aware of the significance of the results they provide. That is why they are unwilling to accept any compromise in their field of work. This is precisely why leading specialists around the world place their trust in Precisa and have done for decades.

PRECISA DNA: SWISS PRECISION

Precisa products are prime examples of Swiss perfection and reliability. They are tried and tested in both demanding laboratory environments and industrial applications, and are subject to rigorous quality controls throughout the entire manufacturing process. Precisa invests continuously in developing new technologies and employs a highly qualified team. The result is a state-of-the-art range of precision instruments for the most exacting demands.

PRECISA DNA: SERIES 520

Swiss idea, Swiss development, Swiss production. With over 40 years knowledge and experience, Precisa Gravimetrics AG has developed one of the most important innovations in weighing technology in recent years.

The Precisa PHASTbloc™ weighing cell allows you to benefit from this advanced technology and provides a technically perfect, easy-to-use, attractive, economical and sustainable balance. Discover the innovations of the 520 series. We look forward to inspiring you - as many users have been already.

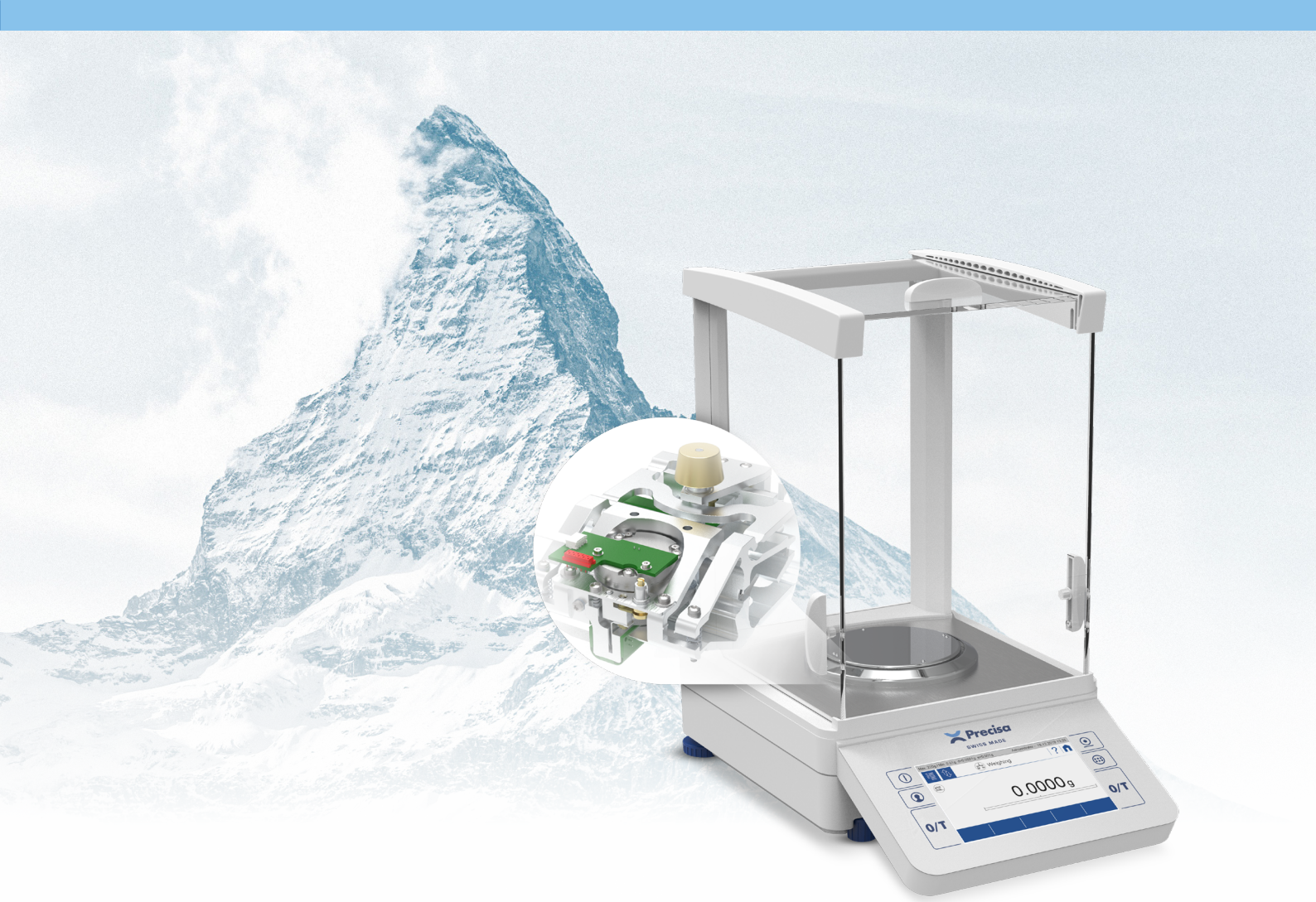

PHASTbloc™

PHASTbloc™ (Precisa Hybrid Advanced Sensor Technology) - Precisa's new and unique weighing technology combines the benefits of current weighing cells with monolithic design. The ultimate in Swiss engineering from Precisa has created a world first weighing technology, representing 40 years of knowledge and expertise in developing weighing technologies and innovations. The sustainable hybrid approach in the PHASTbloc™ unites the benefits of a conventional weighing cell and monolithic design. This enables the efficient maintenance and repair of a weighing cell instead of replacing it - sustainability in practice. Advanced materials, engineering and unique manufacturing methods lift quality and performance to new heights.

Using a range of materials such as standard grade and high tech aerospace aluminium, maximises reparability and performance, offering affordability and an environmentally friendly product. All parts of the PHASTbloc™ are manufactured with the highest Swiss quality and precision. The division of the weighing cell into functional parts not only allows an optimal choice of material and manufacturing process for each section, but also opens up the possibility of replacing parts. This allows the PHASTbloc™ to be maintained cost-effectively and ensures a long life.

All this makes the PHASTbloc™ weighing cell the most ecological and economical of its kind without compromising on performance.

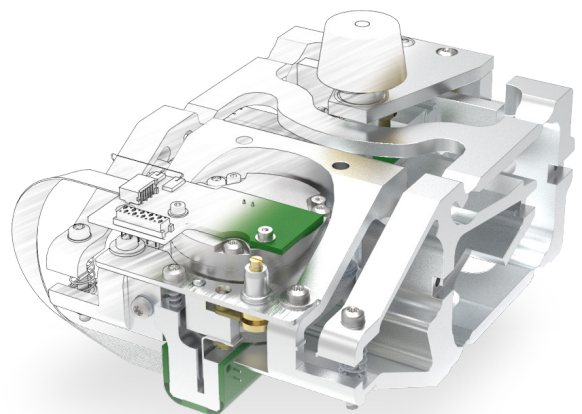

520 PT FEATURES

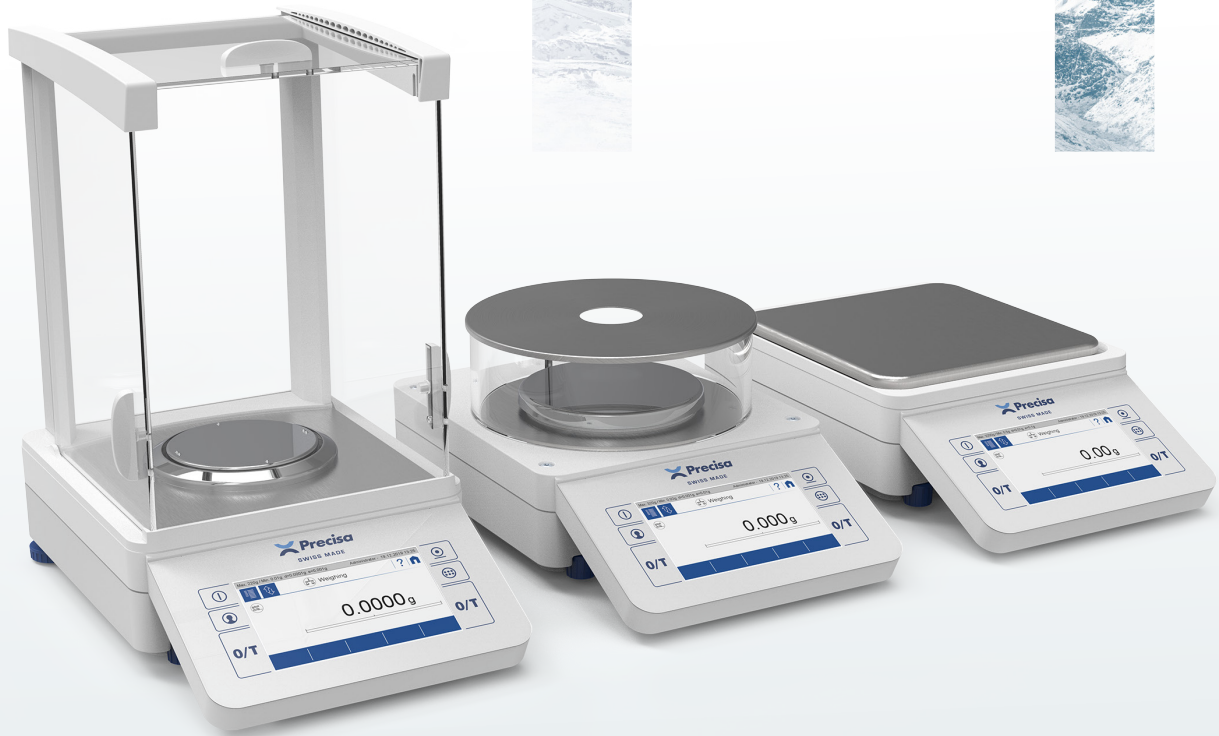

520 PT: THE SMART BALANCE

With a 6.4" touch control screen, this is the largest in its class! In working environments such as laboratories, research and development, where flexibility and individual user solutions are required, the 520 PT reveals its full potential. With the advantages of the touch screen in terms of visualization, intuitive operation and customization options, the 520 PT offers the highest degree of flexibility, safety and user-friendliness. Six large fixed keys for the most common operating functions - on/off switch, tare, printing, user and application selection - optimize operation without reducing the display area.

With a complete range of applications such as counting, density, animal weighing, percentage, check, ... and the RS232, USB, plus optional Ethernet, WiFi and Bluetooth interfaces, there are no limits to the 520 PT. The 520 PT with its touch screen is the right choice for maximum user-friendliness and flexibility.

Features:



Applications:



See Features/Applications for an explanation of terms.

520 PT FEATURES

PRECISA SERIES 520 PT

Touchscreen

Large 6.4" touch-sensitive user interface with an elegant and bright 5" colour display.

As with mobile devices, the balance's user interface is intuitive and easy to use. Precisa's user-friendly operating concept makes navigation and configuration much easier thanks to the colour scheme.

The desired application is just a fingertip away. The colour logic displays all touchable surfaces in blue. The "Home" button, which is always available, guides you back to the active application.

- 6.4" touch-sensitive user interface
- 5" anti-reflective display
- Shock and scratch resistant
- Suitable to operate with laboratory gloves
- UV resistant
- Frameless for easy and thorough cleaning.

6 Fixed Keys

Six quick-select keys with the most important functions.

To the right and left of the display there are three fixed position touch-sensitive keys. This gives you access at all times to the most important functions: switch on/off, print, application and user screen as well as taring or zeroing.

Context Help

We simplify your life!

Simply touch the help icon and the context help appears on screen. You will find all relevant information, even if you are in an application, the context menu, the user screen or anywhere else. Help is available at the touch of a button! No more tedious and time-consuming browsing through user manuals.

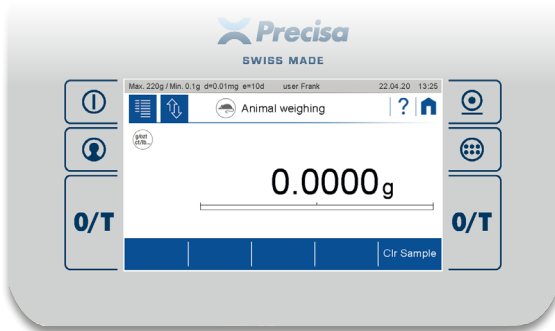

Touchscreen

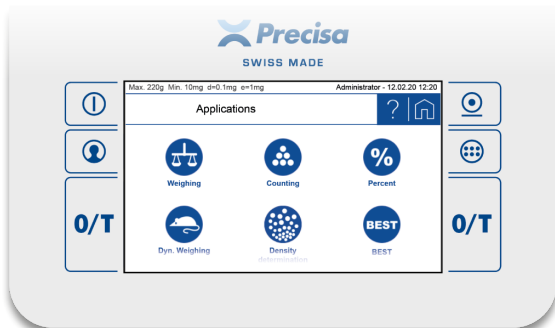

Applications

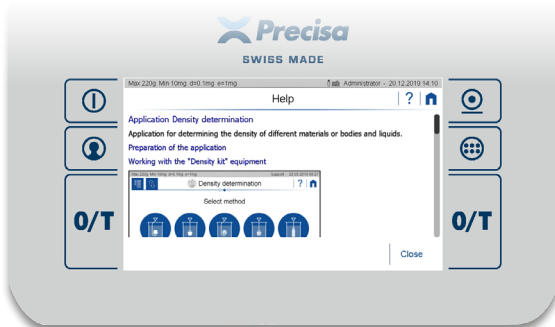

Integrated Help Functionality

520 PT FEATURES



Customizable User Interface



Manage Users and Rights-Access



Electronic Levelling Indicator

PRECISA SERIES 520 PT

Customize Your Screen

Individual and efficient.

The display of the 520 PT series can be fully adapted to suit your requirements. You decide what information is displayed in the notification area.

Six soft buttons can be freely configured in the action bar. Assign the most important functions to them or create a folder with up to four commands. Complex functions and processes are simplified in this way so that you can concentrate on your main tasks.

Nothing stands in the way of simple, efficient and safe work.

User Management

Individual and secure.

With the built-in, extensive user management, your balance can be optimally adjusted for up to 15 users.

Simply select your profile at the start of work and the balance loads your personal settings.

The balance's individual configuration is saved in your user profile: whether with full access rights, restricted to a single application or simply with the basic operating settings for right-handed or left-handed users. Each profile can be protected with a unique password.

Electronic Level Indicator

Improved precision.

With the built-in electronic levelling, you can be assured that your balance is level at all times. If the balance is no longer level, a message appears on the display. The balance can also be configured so that it can only be operated when level.

To reset the position of the balance correctly, a levelling guide is displayed on the screen. It shows which direction the feet need to be moved.

520 PT FEATURES



Communication and Interfaces

Unlimited connectivity.

The 520 PT Series meets your communication needs. Whether you already have a LIMS in a paperless laboratory or not, we offer the balance with a range of standard interfaces:

- USB type A (host)
- USB type B (device)
- RS232
- 10/100M Ethernet (optional)
- Wi-Fi (optional)

The integration of your balance into the network, and the connection to a PC or printer is very easy.



520 PB FEATURES



520 PB: TIMELESS AND PROVEN IN EVERYDAY PRACTICE

Five high-quality mechanical membrane keys guarantee longevity and a tactile feel with clearly noticeable feedback to the user. The 520 PB is also suitable for laboratories, the pharmaceutical, food, light and consumer goods industries as well as production or for pharmacies and jewellery. Wherever precise and demanding routine work is carried out on a regular basis, reliability and user-friendliness are key components.

State-of-the-art with an extensive range of applications such as counting, density, animal weighing etc. Including statistics, a wide range of languages, RS232 and USB interfaces, all current and future requirements are met. It has never been so easy to choose the right balance.

Features:

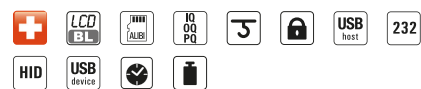

Applications:



See Features/Applications for an explanation of terms.

520 PB FEATURES

PRECISA SERIES 520 PB

Robust & Durable Design

Designed for almost any environment.

When designing the 520 PB series, attention was paid to robustness and durability. The housing materials, keyboard and display were chosen to withstand rough environments and meet heavy demands.



Robust and Durable Design

Large Alpha Numeric LCD

Large and easy to read.

The bright, high-contrast LC display with backlight and large digits (> 15mm) offers excellent readability.

5 Key Membrane Keypad

Clear and simple.

The five softkeys structure the various application possibilities in a user-friendly manner and considerably improve the operation of the device.

Navigation has been enhanced and simplified for the 520 PB series.



5 Key Membrane Keypad

Extensive Range of Applications

Advanced functionality.

The desired application can be easily selected from a large number of specific applications and guarantees maximum functionality. The 520 PB series offers an extremely wide range of applications for almost every possible application.

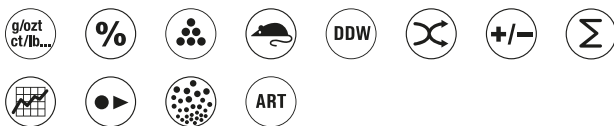

Extensive Range of Applications

520 COMMON FEATURES



Sturdy Housing

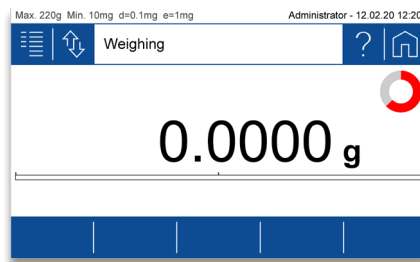

Real-time Stability Indicator

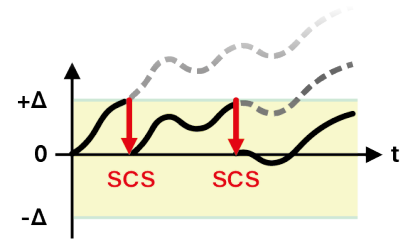

Self-calibration System

Sturdy Housing

Robust and durable.

Precisa's instrument housings have always been characterized by their robustness and longevity. This has not changed with the current Series 520.

Both the new PHASTbloc™ weighing cell and the entire balance have been designed for optimal material choice. For this reason, the base is a robust die-cast aluminium housing and the upper part is made of fibreglass-reinforced and durable thermoplastic compound.

Stability Indicator

Real-time stability indicator with stability prediction.

The optical stability indicator indicates measurement faults and provides real-time information on the influences of the environment which may affect the balance.

The more stable the environment, the faster the stability indicator disappears and a reliable value is displayed. The stability indicator allows estimating how long it takes for the balance to display a reliable value.

Self Calibration System (SCS)

Always accurate.

The Self Calibration System (SCS) developed by Precisa enables automatic adjustment / calibration of the balance. The function can be set to be temperature and/or time-controlled, so that the user can always expect maximum measuring accuracy. This option is often used in regulated environments (GLP).

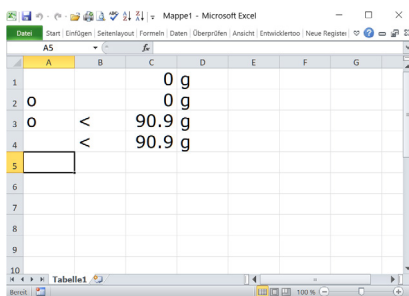

Human Input Device (HID)



USB (Flash Drive)

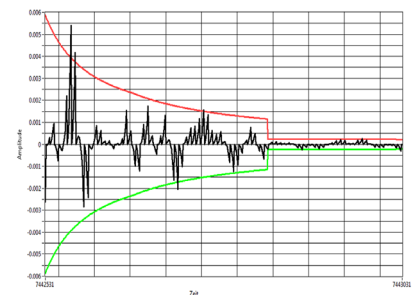

ENC™ Environmental Noise Cancelling System

Human Input Device (HID)

Direct balances - PC communication.

The balance can be connected to a computer via a USB cable and is recognized by the computer as a human input device (HID). This turns your balance into a keyboard and weight values can be sent directly from the balance to the PC without installing any software. No additional authorizations, apps or tools are required. In this way, the data can be written directly into the open program, for example Excel, Word, Notepad, etc.

USB (Flash Drive)

Saving data on a USB memory stick.

Data such as weight values or reports can be saved directly to a connected USB memory stick. This allows them to be processed on a PC that is not connected.

Other Features

Suitable for a wide range of uses.

- Multilingual
- Improved digital filter to eliminate external effects (ENC™)
- Space saving
- Maximum stability, thanks to four adjustable feet
- Weighing below option
- Optionally IP65 protected

MODELS

PT MODEL

Model	Capacity	Readability	Repeatability (Load >5%)	Min. Weight (1%, k=2, Load >5%)	Linearity	Pan Size (mm)	Class / „e“	Response Time	Item No.
Analytical Balances									Net weight 6.6 kg
PT 120A	120 g	0.1 mg	0.1 mg	20.0 mg*	0.2 mg	ø 90	I / 1 mg**	2 s	520-9221-002***
PT 220A	220 g	0.1 mg	0.1 mg	20.0 mg*	0.2 mg	ø 90	I / 1 mg**	2 s	520-9222-002***
Precision Balances									Net weight 5.6 kg
PT 320M	320 g	1 mg	1 mg	200 mg*	1.5 mg	ø 120	II / 10 mg**	1.5 s	520-9321-002***
PT 620M	620 g	1 mg	1 mg	200 mg*	1.5 mg	ø 120	II / 10 mg**	1.5 s	520-9322-002***
PT 320C	320 g	0.01 g	0.005 g	1 g*	10 mg	186 x 186	-	1.5 s	520-9421-002***
PT 620C	620 g	0.01 g	0.005 g	1 g*	10 mg	186 x 186	II / 0.1 g**	1.5 s	520-9422-002***
PT 1200C	1200 g	0.01 g	0.01 g	2 g*	10 mg	186 x 186	II / 0.1 g**	1.5 s	520-9423-002***
PT 2200C	2200 g	0.01 g	0.01 g	2 g*	10 mg	186 x 186	II / 0.1 g**	1.5 s	520-9424-002***
PT 3200C	3200 g	0.01 g	0.01 g	2 g*	10 mg	186 x 186	II / 0.1 g**	1.5 s	520-9425-002***
PT 4200C	4200 g	0.01 g	0.01 g	2 g*	10 mg	186 x 186	II / 0.1 g**	1.5 s	520-9426-002***
PT 3200D	3200 g	0.1 g	0.05 g	10 g*	0.1 g	186 x 186	II / 0.1 g**	1 s	520-9521-002***
PT 6200D	6200 g	0.1 g	0.05 g	10 g*	0.1 g	186 x 186	II / 1.0 g**	1 s	520-9522-002***
PT 10200D	10200 g	0.1 g	0.1 g	20 g*	0.15 g	186 x 186	II / 1.0 g**	2 s	520-9523-002***
PT 10200G	10200 g	1 g	0.5 g	100 g*	0.5 g	186 x 186	II / 1.0 g**	1.5 s	520-9621-002***

PB MODEL

Model	Capacity	Readability	Repeatability (Load >5%)	Min. Weight (1%, k=2, Load >5%)	Linearity	Pan Size (mm)	Class / „e“	Response Time	Item No.
Analytical Balances									Net weight 6.6 kg
PB 120A	120 g	0.1 mg	0.1 mg	20.0 mg*	0.2 mg	ø 90	I / 1 mg**	2 s	520-9211-002***
PB 220A	220 g	0.1 mg	0.1 mg	20.0 mg*	0.2 mg	ø 90	I / 1 mg**	2 s	520-9212-002***
Precision Balances									Net weight 5.6 kg
PB 320M	320 g	1 mg	1 mg	200 mg*	1.5 mg	ø 120	II / 10 mg**	1.5 s	520-9311-002***
PB 620M	620 g	1 mg	1 mg	200 mg*	1.5 mg	ø 120	II / 10 mg**	1.5 s	520-9312-002***
PB 320C	320 g	0.01 g	0.005 g	1 g*	10 mg	186 x 186	-	1.5 s	520-9411-002***
PB 620C	620 g	0.01 g	0.005 g	1 g*	10 mg	186 x 186	II / 0.1 g**	1.5 s	520-9412-002***
PB 1200C	1200 g	0.01 g	0.01 g	2 g*	10 mg	186 x 186	II / 0.1 g**	1.5 s	520-9413-002***
PB 2200C	2200 g	0.01 g	0.01 g	2 g*	10 mg	186 x 186	II / 0.1 g**	1.5 s	520-9414-002***
PB 3200C	3200 g	0.01 g	0.01 g	2 g*	10 mg	186 x 186	II / 0.1 g**	1.5 s	520-9415-002***
PB 4200C	4200 g	0.01 g	0.01 g	2 g*	10 mg	186 x 186	II / 0.1 g**	1.5 s	520-9416-002***
PB 3200D	3200 g	0.1 g	0.05 g	10 g*	0.1 g	186 x 186	II / 0.1 g**	1 s	520-9511-002***
PB 6200D	6200 g	0.1 g	0.05 g	10 g*	0.1 g	186 x 186	II / 1.0 g**	1 s	520-9512-002***
PB 10200D	10200 g	0.1 g	0.1 g	20 g*	0.15 g	186 x 186	II / 1.0 g**	2 s	520-9513-002***
PB 10200G	10200 g	1 g	0.5 g	100 g*	0.5 g	186 x 186	II / 1.0 g**	1.5 s	520-9611-002***

* USP Min. weight (0.1%, k=2, Load >5%) = Min. weight x 10

** EU/OIML/UKCA type approval on demand, Initially verified with SCS (-001) only

*** -001 for balance with SCS / -002 for balance without SCS

OPTIONS AND ACCESSORIES

Options	PT	PB
EU-Verification according to 2014/31/EU by Precisa (initial verification) incl. alibi memory, available only for balances with EU/OIML/UKCA type approval and SCS	350-8938	350-8938
Protection IP65, protection against ingress of dust and low pressure water jets, fitted at factory, not all types available	350-8754 on demand	350-8754 on demand
SCS PT: Self calibration System with clock, automatic on temperature change and real-time programmable	520-xxxx-001	-
SCS PB: Self calibration System with clock, automatic on temperature change and real-time programmable	-	520-xxxx-001

Applications	PT	PB
BEST Buoyancy Error Suppression Technology	350-8739-001	-

Accessories	PT	PB
Draft shield PB	350-8735	350-8735
Draft shield PB + Weighing pan M* Includes all necessary parts: 350-8735, Weighing pan M*	350-8735-001	350-8735-001
Draft shield PB short	350-8742	350-8742
Draft shield PB short + Weighing pan M* Includes all necessary parts: 350-8742, Weighing pan M*	350-8742-001	350-8742-001
Remote display free-standing, incl. 1.5 m cable	-	350-8401-001
Remote display with wall bracket, incl. 1.5 m cable	-	350-8401-002
Hook for weighing below the balance	350-8744	350-8744
Animal weighing bowl complete for 0.01g, 0.1g and 1g balances	350-8743	350-8743
Density kit for 0.1mg balances Container size Ø 75mm, h= 100mm	350-8719	350-8719
Density kit solids only (w/o Glass body and Hook) for 0.1mg balances Container size Ø 75mm, h= 100mm	350-8720	350-8720
Glass body 10ccm for density determination of liquids	350-7054	350-7054
Downholder for samples with density < 1 g/cm3	350-7194	350-7194
Single foot switch USB for one function: tare, print, ...	350-8747-001	350-8747-001
Double foot switch USB for two functions: tare and print, tare and ...	350-8747-002	350-8747-002
Protective cover 520 for the whole balance (0.1mg, 1mg), set of 5 pieces	350-8745-001	350-8745-001
Protective cover 520 for the whole balance (0.01g, 0.1g, 1g), set of 5 pieces	350-8745-002	350-8745-002
Carrying case 520	350-8746	350-8746
LAN Ethernet connection 520 PT	350-8939-000	-
WiFi connection 520 PT	350-8941	-
Interface box, LAN ethernet connection	-	350-8940-001
Interface box, WiFi connection	-	350-8940-002







































Operating Temperature	Line Voltage, Tolerance	Power Consumption	Frequency
5 .. 40 °C (41°F .. 104°F)	115V / 230V, +15% / -20%	18 VA	50 - 60 Hz

SPECIAL PRODUCTS ACCESSORIES

Common Accessories	520 PT/PB
Printer LP4024, 230V / 115V	350-8391
Bluetooth connection for Printer LP4024	350-8391-001
Paper roll for Printer LP4024, set of 4 pieces	350-8392
Ribbon for Printer LP4024	PN 3953-013
Paper roll for Printer CBM910	350-8366
Ribbon for Printer CBM910	350-8367
Data cable DB9m-RJ45, 1.5m, for balance used as reference balance	350-8661
Data cable DB9m-DB9f, 1.5m, (PC/Printer LP 4024, 1:1)	350-8672
Data cable DB9m-DB25m, 1.5m, (Printer CBM910)	350-8673
USB cable A-B, 1.5m, (PC)	PN 3950-125
Interface box, Interface and power splitter	350-8940-000
Interface box, Bluetooth connection	on demand
HID cable, RS232, DB9m-USB-A, 1.5m, (PC), (x: 0=e, 1=d, 2=f)	use PN 3950-125
External USV accu power pack for continuous operation	350-8662
Power splitter cable	350-8399
Anti-theft device, mechanical	350-8555
Carat bowl (for diamond weighing)	350-8322

PrecisaBUS Accessories (available on demand only)	520 PT/PB
Signal Lamp, indicator with 3 lamps, green / red / yellow	350-8734
Horn for signal lamp	350-8533
Input / Output module with 6 TTL inputs / 8 relay outputs	on demand

FEATURES & APPLICATIONS

Features Series 520		PT	PB	Applications Series 520		PT	PB
	Swiss Made	✓	✓		Units g, mg, ozt, lb, tael, etc.	✓	✓
	Color Touch Screen	✓			Percent weighing	✓	✓
	Backlit LCD		✓		Piece counting	✓	✓
	LAN Ethernet connection	AC	AC		Animal weighing	✓	✓
	WiFi connection	AC	AC		Dynamic difference weighing	✓	✓
	Bluetooth connection	AC	AC		Free conversion Area Conversion	✓	✓
	External I/O (tare, print ..., relay)	OD	OD		Statistics	✓	✓
	Integrated alibi memory (with EU type approval)	✓	✓		Recorder	✓	✓
	Support IQ/OQ/PQ	✓	✓		Minimum sample weight	✓	
	Integrated audit trail	✓			Automatic repeatability test	✓	✓
	Below balance weighing	✓	✓		Maintenance Service Package	✓	
	Anti-theft protection (mechanical and code)	✓	✓		Net total application: Add up summation (Dosing program)	✓	✓
	Easy alphanumeric input	✓			Checkweighing	✓	✓
	USB host (barcode, flash drive, ...)	✓	✓		Density determination	✓	✓
	RS232 interface (for PC/printer)	✓	✓		Buoyancy error suppression technology	AC	
	Direct tare and reference weight entry	✓					
	Human Interface Device (for PC)	✓	✓				
	USB device (for PC)	✓	✓				
	Clock (GLP/GMP printout, auto-cal, etc.)	✓	✓				
	External Calibration, with calibration warning	✓	✓				
	Self-calibration system, fully automated	AC	AC				
	Identifier and label handling	✓					
	EU/OIML/UKCA type approval	AC	AC				

AC = accessory or optional built-in at factory
OD = on demand

DIMENSIONS

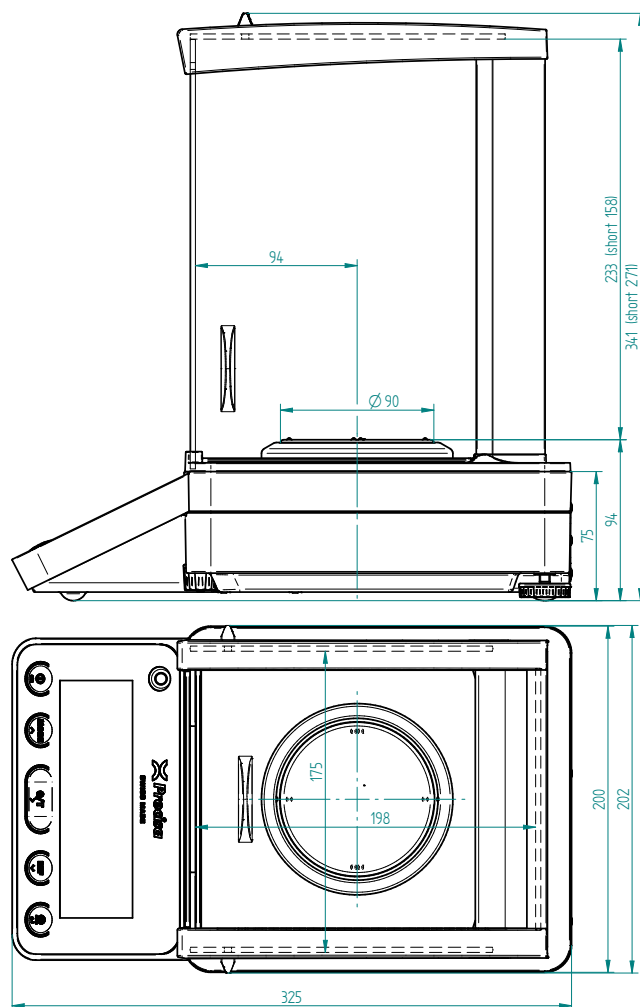
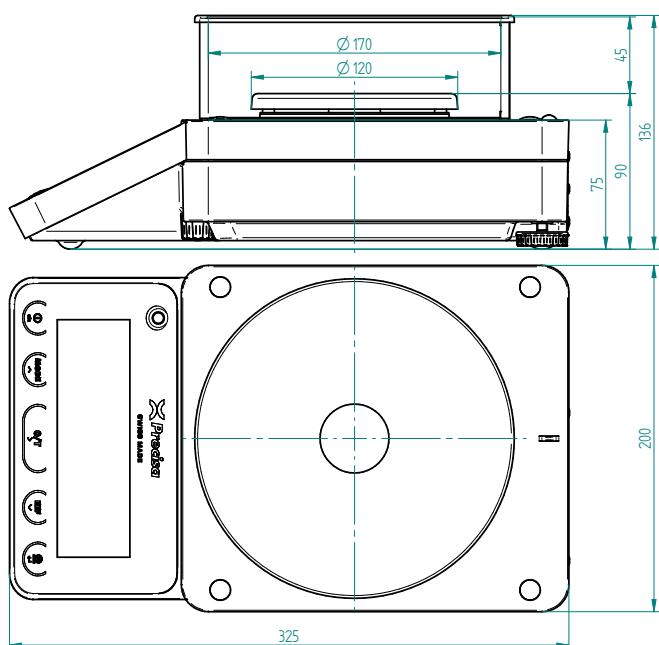
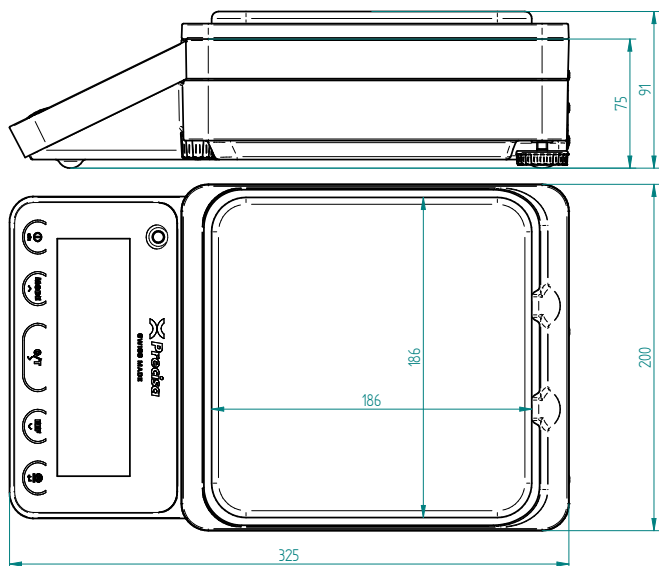

TECHCOMP GROUP

In addition to Precisa, Techcomp Europe comprises of the following companies:

