

# Operating Manual

Translation of the original operating manual

## KBF (E5.3)

Constant climate chambers with program control

Model	Model version	Art. No.
KBF 115	KBF115-230V	9020-0267, 9120-0267
KBF 115-UL	KBF115UL-240V	9020-0268, 9120-0268
KBF 240	KBF240-230V	9020-0269, 9120-0269
KBF 240-UL	KBF240UL-240V	9020-0270, 9120-0270
KBF 720	KBF720-230V	9020-0271, 9120-0271
KBF 720-UL	KBF720UL-240V	9020-0272, 9120-0272
KBF 1020	KBF1020-230V	9020-0264, 9120-0264
	KBF1020-240V	9020-0315, 9120-0315

## KBF P (E5.3)

Constant climate chambers with ICH compliant illumination with program control and adjustable light cassettes

Model	Model version	Art. No.
KBF P 240	KBFP240-230V	9020-0273, 9120-0273
KBF P 240-UL	KBFP240UL-240V	9020-0274, 9120-0274
KBF P 720	KBFP720-230V	9020-0275, 9120-0275
KBF P 720-UL	KBFP720UL-240V	9020-0276, 9120-0276

### BINDER GmbH

Address	Post office box 102 D-78502 Tuttlingen
Tel.	+49 7462 2005 0
Fax	+49 7462 2005 100
Internet	<a href="http://www.binder-world.com">http://www.binder-world.com</a>
E-mail	<a href="mailto:info@binder-world.com">info@binder-world.com</a>
Service Hotline	+49 7462 2005 555
Service Fax	+49 7462 2005 93 555
Service E-Mail	<a href="mailto:service@binder-world.com">service@binder-world.com</a>
Service Hotline USA	+1 866 885 9794 or +1 631 224 4340 x3
Service Hotline Asia Pacific	+852 390 705 04 or +852 390 705 03
Service Hotline Russia and CIS	+7 495 98815 16

---

## Content

<b>1. SAFETY</b> .....	<b>5</b>
1.1 Legal considerations .....	5
1.2 Structure of the safety instructions.....	5
1.2.1 Signal word panel .....	5
1.2.2 Safety alert symbol .....	6
1.2.3 Pictograms .....	6
1.2.4 Word message panel structure .....	7
1.3 Localization / position of safety labels on the unit.....	7
1.4 Type plate .....	9
1.5 General safety instructions on installing and operating the constant climate chamber.....	10
1.6 Intended use .....	12
1.7 Operating instructions .....	13
1.8 Measures to prevent accidents .....	13
1.9 Resistance of the humidity sensor against harmful substances.....	14
<b>2. UNIT DESCRIPTION</b> .....	<b>15</b>
2.1 Unit overview.....	16
2.2 Instrument panel for KBF / KBF P.....	16
2.3 Lateral control panel, right side KBF / KBF P .....	17
2.4 Lateral control panel, left side (KBF P, option KBF) .....	18
2.5 Rear view with water connections .....	19
<b>3. COMPLETENESS OF DELIVERY, TRANSPORTATION, STORAGE, AND INSTALLATION</b> .....	<b>20</b>
3.1 Unpacking, and checking equipment and completeness of delivery.....	20
3.2 Guidelines for safe lifting and transportation .....	21
3.3 Storage.....	22
3.4 Location of installation and ambient conditions .....	22
<b>4. INSTALLATION AND CONNECTIONS</b> .....	<b>24</b>
4.1 Spacers for rear wall distance.....	24
4.2 Wastewater connection.....	24
4.3 Freshwater supply.....	25
4.3.1 Automatic freshwater supply via water pipe .....	25
4.3.2 Manual freshwater supply via external freshwater can (option).....	26
4.3.3 Connection kit for connecting the unit to the water main.....	26
4.3.4 Safety kit: Hose burst protection device with reflux protection device (available via BINDER INDIVIDUAL customized solutions).....	27
4.4 Installation and connection of the light cassettes (KBF P) .....	29
4.5 Electrical connection .....	30
4.6 Connection of the voltage changer (option for KBF P 240 and KBF).....	31
<b>5. START UP</b> .....	<b>33</b>
5.1 Function overview of the MB1 display program controller.....	33
5.2 Operating modes.....	34
5.3 Performance after power failures.....	34
5.4 Turning on the unit .....	35
<b>6. MB1 CONTROLLER SETTINGS</b> .....	<b>36</b>
6.1 Selection of the MB1 controller's menu language .....	36
6.2 Function overview of the MB1 program controller displays .....	37
6.3 Menu settings in the "User-settings" menu .....	38
6.4 Menu settings in the "User Level" menu .....	39

---

<b>7.</b>	<b>GRAPHIC REPRESENTATION OF THE HISTORICAL MEASUREMENT (CHART RECORDER FUNCTION)</b> .....	<b>40</b>
7.1	Setting the storage rate.....	42
<b>8.</b>	<b>MANUAL MODE</b> .....	<b>43</b>
8.1	Entering the set point values.....	43
8.2	Entering the set point values for KBF P when operating without illumination .....	45
8.3	Performance after power failure in Manual Mode.....	45
<b>9.</b>	<b>PROGRAM OPERATION</b> .....	<b>45</b>
9.1	Menu-based program entry.....	46
9.2	Entry of temperature values and fan speed.....	46
9.3	Entry of humidity values.....	49
9.4	Selecting between “set-point ramp” and “set-point step”.....	50
9.5	Program entry as “set-point ramp” or as “set-point step”.....	51
9.6	Information on programming different temperature or humidity transitions.....	53
9.7	Repetition of a section or several sections within a program .....	54
9.8	Performance after power failure in Program Mode.....	54
9.9	Starting a previously entered program.....	55
9.10	Deleting a program.....	55
9.11	Template for temperature profile.....	56
9.12	Template for humidity profile.....	57
9.13	Program table template for temperature and fan speed rate.....	58
9.14	Program table template for humidity.....	59
<b>10.</b>	<b>TEMPERATURE SAFETY DEVICES</b> .....	<b>60</b>
10.1	Over temperature protective device (class 1).....	60
10.2	Safety controller (temperature safety device class 3.1).....	60
10.2.1	Safety controller set-point types .....	60
10.2.2	Checking and setting safety controller set-point type and safety controller set-point .....	61
10.3	Temperature safety device class 3.3 (option).....	62
10.3.1	Temperature safety device class 3.1.....	63
10.3.2	Temperature safety device class 3.2.....	64
<b>11.</b>	<b>NOTIFICATION AND ALARM FUNCTIONS</b> .....	<b>65</b>
11.1	Notification and alarm system overview (auto diagnosis system).....	65
11.2	Messages concerning the humidity system.....	66
11.3	Resetting the notification or alarm messages.....	67
<b>12.</b>	<b>HUMIDITY SYSTEM</b> .....	<b>68</b>
12.1	Function of the humidifying and dehumidifying system .....	70
<b>13.</b>	<b>DEFROSTING AT REFRIGERATING OPERATION</b> .....	<b>71</b>
<b>14.</b>	<b>ICH COMPLIANT ILLUMINATION ACCORDING TO CPMP/ICH/279/95 (Q1B)</b> .....	<b>72</b>
14.1	BINDER ICH light.....	72
14.2	Adjustable light cassettes .....	72
<b>15.</b>	<b>OPTIONS</b> .....	<b>75</b>
15.1	Communication software APT-COM™ 3 DataControlSystem (option) .....	75
15.2	Interface RS 422 (option).....	75
15.3	Data logger kits (option).....	75
15.4	Analog outputs for temperature and humidity (option) .....	76
15.5	Zero-voltage relay alarm outputs for temperature and humidity (option) .....	76
15.6	Water protected internal socket (option – not for UL units) .....	77
15.7	Keyboard locking (option) .....	78

---

15.8	Additional flexible Pt 100 temperature sensor (option).....	78
15.9	External freshwater and wastewater cans (option).....	79
15.9.1	Mounting the freshwater can .....	79
15.9.2	Mounting the wastewater can .....	81
15.9.3	Mounting with wastewater recycling .....	82
15.10	BINDER Pure Aqua Service (option) .....	83
<b>16.</b>	<b>MAINTENANCE, CLEANING, AND SERVICE .....</b>	<b>83</b>
16.1	Maintenance intervals, service.....	83
16.2	Replacement of the fluorescent tubes .....	84
16.3	Cleaning and decontamination .....	85
16.3.1	Cleaning.....	85
16.3.2	Decontamination.....	86
16.4	Sending the unit back to BINDER GmbH .....	87
<b>17.</b>	<b>DISPOSAL.....</b>	<b>88</b>
17.1	Disposal of the transport packing .....	88
17.2	Decommissioning.....	88
17.3	Disposal of the unit in the Federal Republic of Germany .....	88
17.4	Disposal of the unit in the member states of the EC except for the Federal Republic of Germany .....	89
17.5	Disposal of the unit in non-member states of the EC .....	91
<b>18.</b>	<b>TROUBLESHOOTING .....</b>	<b>91</b>
<b>19.</b>	<b>TECHNICAL DESCRIPTION.....</b>	<b>94</b>
19.1	Factory calibration and adjustment.....	94
19.2	Over current protection .....	94
19.3	Definition of usable volume .....	94
19.4	KBF Technical Data .....	95
19.5	KBF P Technical Data.....	97
19.6	Equipment and options (extract).....	99
19.7	Spare parts and accessories (extract) .....	100
19.8	Dimensions KBF 115 .....	102
19.9	Dimensions KBF 240 / KBF P 240 .....	103
19.10	Dimensions KBF 720 / KBF P 720 .....	104
19.11	Dimensions KBF 1020 .....	105
<b>20.</b>	<b>CERTIFICATES.....</b>	<b>106</b>
20.1	EC Declaration of conformity .....	106
20.2	Certificate for the GS mark of conformity of the “Deutsche Gesetzliche Unfallversicherung e.V.” (German Social Accident Insurance) DGUV.....	108
<b>21.</b>	<b>PRODUCT REGISTRATION .....</b>	<b>110</b>
<b>22.</b>	<b>CONTAMINATION CLEARANCE CERTIFICATE .....</b>	<b>111</b>
22.1	For units located outside North America and Central America.....	111
22.2	For units in North America and Central America .....	114





**Dear customer,**

For the correct operation of the constant climate chamber KBF / KBF P, it is important that you read this operating manual completely and carefully and observe all instructions as indicated. Failure to read, understand and follow the instructions may result in personal injury. It can also lead to damage to the unit and/or poor equipment performance.

## 1. Safety

This operating manual is part of the components of delivery. Always keep it handy for reference. The device should only be operated by laboratory personnel especially trained for this purpose and familiar with all precautionary measures required for working in a laboratory. Observe the national regulations on minimum age of laboratory personnel. To avoid injuries and damage observe the safety instructions of the operating manual.

	 <b>WARNING</b>
	<p><b>Failure to observe the safety instructions.</b>  <b>Serious injuries and unit damage.</b></p> <ul style="list-style-type: none"> <li>➤ Observe the safety instructions in this operating manual.</li> <li>➤ Carefully read the complete operating instructions of the constant climate chamber.</li> </ul>

### 1.1 Legal considerations

This operating manual is for informational purposes only. It contains information for installing, start-up, operation and maintenance of the product. Note: the contents and the product described are subject to change without notice.

Understanding and observing the instructions in this operating manual are prerequisites for hazard-free use and safety during operation and maintenance. In no event shall BINDER be held liable for any damages, direct or incidental arising out of or related to the use of this manual.

This operating manual cannot cover all conceivable applications. If you would like additional information, or if special problems arise that are not sufficiently addressed in this manual, please ask your dealer or contact us directly by phone at the number located on page one of this manual

Furthermore, we emphasize that the contents of this operating manual are not part of an earlier or existing agreement, description, or legal relationship, nor do they modify such a relationship. All obligations on the part of BINDER derive from the respective purchase contract, which also contains the entire and exclusively valid statement of warranty administration. The statements in this manual neither augment nor restrict the contractual warranty provisions.

### 1.2 Structure of the safety instructions

In this operating manual, the following safety definitions and symbols indicate dangerous situations following the harmonization of ISO 3864-2 and ANSI Z535.6.

#### 1.2.1 Signal word panel

Depending on the probability of serious consequences, potential dangers are identified with a signal word, the corresponding safety color, and if appropriate, the safety alert symbol.

 <b>DANGER</b>
<p>Indicates an imminently hazardous situation that, if not avoided, will result in death or serious (irreversible) injury.</p>

 <b>WARNING</b>
<p>Indicates a potentially hazardous situation which, if not avoided, could result in death or serious (irreversible) injury.</p>

**CAUTION**

Indicates a potentially hazardous situation which, if not avoided, may result in moderate or minor (reversible) injury.

**CAUTION**

Indicates a potentially hazardous situation which, if not avoided, may result in damage to the product and/or its functions or of a property in its proximity.

### 1.2.2 Safety alert symbol







Use of the safety alert symbol indicates a **risk of injury**.

Observe all measures that are marked with the safety alert symbol in order to avoid death or injury.

### 1.2.3 Pictograms

Warning signs			
Electrical hazard	Hot surface	Explosive atmosphere	Stability hazard
Lifting hazard	Scalding hazard	High humidity	UV light hazard
Danger of frost	Risk of corrosion and / or chemical burns	Harmful substances	Biohazard
Pollution Hazard			
Mandatory action signs			
Mandatory regulation	Read operating instructions	Disconnect the power plug	Lift with several persons
Lift with mechanical assistance	Environment protection	Wear protective gloves	Wear safety goggles

Prohibition signs			
 Do NOT touch	 Do NOT spray with water	 Do NOT climb	
	<b>Information</b> to be observed in order to ensure optimum function of the product.		













### 1.2.4 Word message panel structure

<p><b>Type / cause of hazard.</b></p> <p><b>Possible consequences.</b></p> <ul style="list-style-type: none"> <li>⊘ Instruction how to avoid the hazard: prohibition</li> <li>➤ Instruction how to avoid the hazard: mandatory action.</li> </ul>
---

Observe all other notes and information not necessarily emphasized in the same way, in order to avoid disruptions that could result in direct or indirect injury or property damage.

### 1.3 Localization / position of safety labels on the unit

The following labels are located on the unit:

Pictograms (warning signs)			
	<p>Risk of injury (on outer door, UL units only).</p> <p>Observe the safety instructions in the operating manual.</p>		
	<p>Hot surface (inner glass door above the glass door handle)</p>		
	<table border="1" style="width: 100%;"> <tr> <td style="background-color: #f4a460; color: white; text-align: center;">  <b>WARNING</b> </td> <td> <p><b>UV light.</b></p> <p>Minimize eye and skin exposure. Follow instructions of the operating manual.</p> </td> </tr> </table> <p style="text-align: right;">UV light hazard (on outer door, KBF P only)</p>	 <b>WARNING</b>	<p><b>UV light.</b></p> <p>Minimize eye and skin exposure. Follow instructions of the operating manual.</p>
 <b>WARNING</b>	<p><b>UV light.</b></p> <p>Minimize eye and skin exposure. Follow instructions of the operating manual.</p>		
	<table border="1" style="width: 100%;"> <tr> <td style="background-color: #f4a460; color: white; text-align: center;">  <b>WARNING</b> </td> <td> <p>Hot Surface.</p> <p>Escape of hot steam.</p> <p>Burning &amp; Scalding Hazard.</p> <p>Access only when cold.</p> </td> </tr> </table> <div style="display: inline-block; text-align: center; margin-left: 20px;">  </div> <p style="text-align: right;">Burning and scalding hazard (on unit rear)</p>	 <b>WARNING</b>	<p>Hot Surface.</p> <p>Escape of hot steam.</p> <p>Burning &amp; Scalding Hazard.</p> <p>Access only when cold.</p>
 <b>WARNING</b>	<p>Hot Surface.</p> <p>Escape of hot steam.</p> <p>Burning &amp; Scalding Hazard.</p> <p>Access only when cold.</p>		
Service label			
<p><b>Service - Hotline</b></p> <p>International: + 49 (0) 7462 / 2005-555            USA Toll Free: + 1 866 885 9794            or: + 1 631 224 4340            Россия и СНГ: + 7 495 98815 17</p> <p>service@binder-world.com            www.binder-world.com </p>			

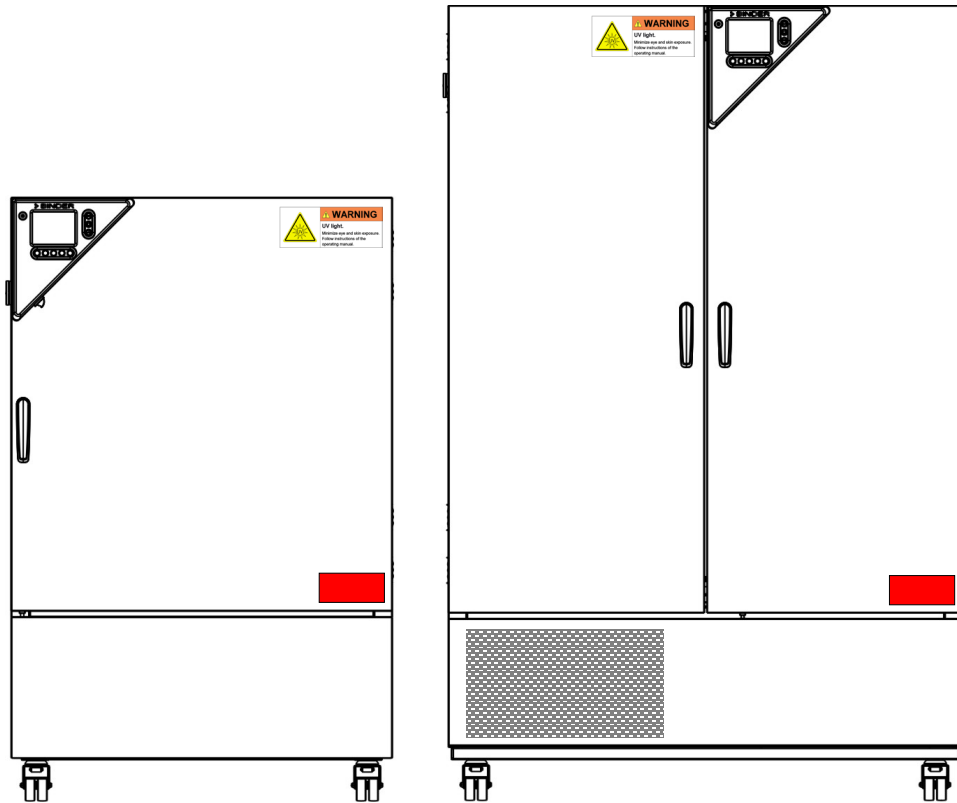

Figure 1: Position of labels on the unit front (example KBF P)

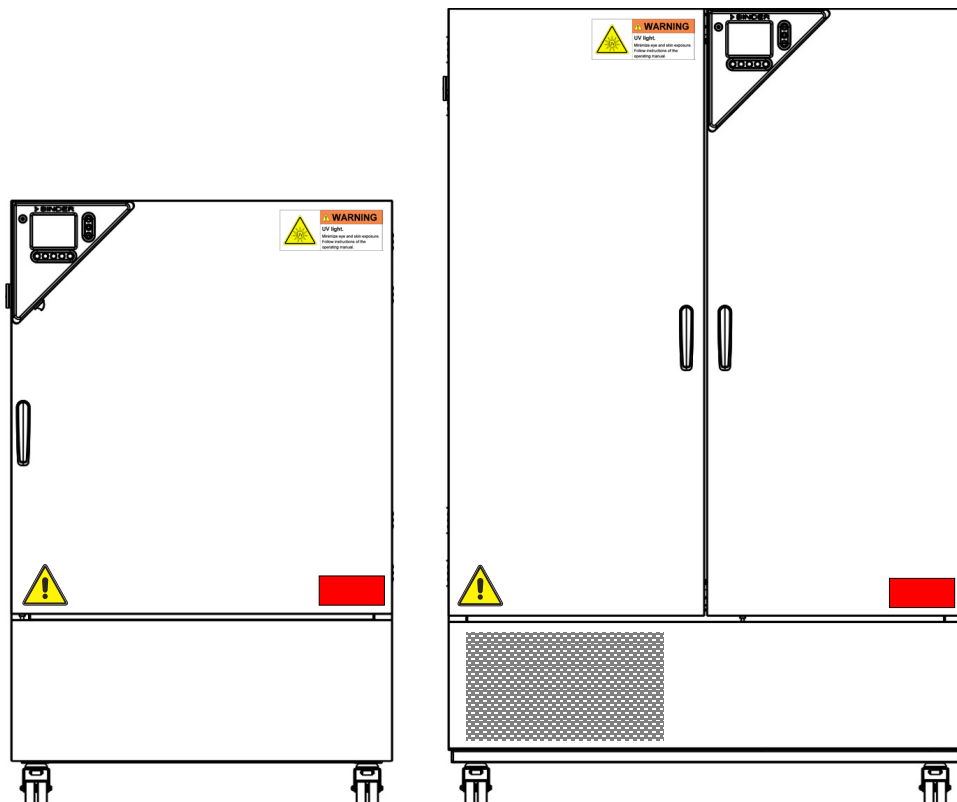

Figure 2: Position of labels on the unit front (example KBF P-UL)

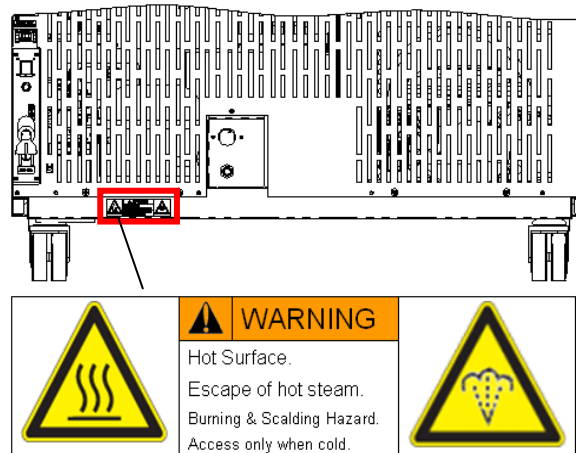

Figure 3: Position of labels on the unit rear

Keep safety labels complete and legible.

Replace safety labels that are no longer legible. Contact BINDER Service for these replacements.

## 1.4 Type plate







Position of type plate: left unit side (seen from front), at the bottom right-hand.

Nominal temp.	70 °C	2,10 kW / 9,5 A				Max. operating pressure 15 bar R 134A – 0,17 kg Contains fluorinated greenhouse gases covered by the Kyoto Protocol
	158 °F	200-230 V / 50 Hz				
IP protection	20	200-230 V / 60 Hz				Serial No. 00-00000 Made in Germany
Safety device	DIN 12880	1 N ~				
Class	3.1					
Art. No.	9020-0269					
Project No.		Constant climate chamber				
Built	2015					
		BINDER GmbH Im Mittleren Ösch 5 78532 Tuttlingen / Germany www.binder-world.com	<b>KBF 240</b> <b>E5.3</b>			

Figure 4: Type plate (example of KBF 240 regular unit 9020-0269)

Indications on the type plate (example)		Information
BINDER		Manufacturer: BINDER GmbH
KBF 240		Model designation
Constant climate chamber		Device name
Serial No.	00-00000	Serial no. of the unit
Built	2015	Year of construction
Nominal temperature	70 °C / 158 °F	Nominal temperature
IP protection	20	IP type of protection acc. to standard EN 60529
Temp. safety device	DIN 12880	Temperature safety device acc. to standard DIN 12880:2007
Class	3.1	Class of temperature safety device
Art. No.	9020-0269	Art. no. of the unit
Project No.	---	Optional: Special application acc. to project no.
2,10 kW		Nominal power
9,5 A		Nominal current

Indications on the type plate (example)	Information
200-230 V / 50 Hz	Nominal voltage range +/-10% at the indicated power frequency
200-230 V / 60 Hz	
1 N ~	Current type
Max. operating pressure 15 bar	Max operating pressure in the refrigerating system (15 bar / 218 PSI)
R 134 A – 0,17 kg	Refrigerant type and filling weight (0.17 kg / 0.37 lbs)
Contains fluorinated greenhouse gases covered by the Kyoto Protocol	Contains fluorinated greenhouse gases covered by the Kyoto Protocol

Symbol on the type plate	Information
	CE conformity marking
	Electrical and electronic equipment manufactured / placed on the market in the EC after 13 August 2005 and be disposed of in separate collection according to the directive 2002/96/EC on waste electrical and electronic equipment (WEEE).
	GS mark of conformity of the “Deutsche Gesetzliche Unfallversicherung e.V. (DGUV), Prüf- und Zertifizierungsstelle Nahrungsmittel und Verpackung im DGUV Test“ (German Social Accident Insurance (DGUV), Testing and Certification Body for Foodstuffs and Packaging Industry in DGUV Test).
 or 	The equipment is certified in the GOST R certification system of GOSTSTANDARD Russia.  The equipment is certified according to Customs Union Technical Regulation (CU TR) for Russia, Belarus and Kazakhstan.
 (UL units only)	The equipment is certified by Underwriters Laboratories Inc.® according to standards CAN/CSA-C22.2 No. 61010-1, 2 <sup>nd</sup> Edition, 2004-07 (Electrical Equipment for Measurement, Control, and Laboratory Use; Part 1: General Requirements); UL 61010-1, 2 <sup>nd</sup> Edition, 2005-07-22 (Electrical Equipment for Measurement, Control, and Laboratory Use; Part 1: General Requirements); IEC 61010-1:2001, 2 <sup>nd</sup> Edition and IEC 61010-2-10 (Particular Requirements for Laboratory Equipment for the heating of materials).

## 1.5 General safety instructions on installing and operating the constant climate chamber



With regard to operating the constant climate chamber KBF / KBF P and to the installation location, please observe the guideline BGI/GUV-I 850-0 on safe working in laboratories (formerly BGR/GUV-R 120 or ZH 1/119 laboratory guidelines issued by the employers' liability insurance association) (for Germany).

BINDER GmbH is only responsible for the safety features of the unit provided skilled electricians or qualified personnel authorized by BINDER perform all maintenance and repair, and if components relating to chamber safety are replaced in the event of failure with original spare parts.



To operate the unit, use only original BINDER accessories or accessories from third-party suppliers authorized by BINDER. The user is responsible for any risk caused by using unauthorized accessories.

	<b>CAUTION</b>
	<p><b>Danger of overheating.</b></p> <p><b>Damage to the unit.</b></p> <ul style="list-style-type: none"> <li>∅ Do NOT install the unit in unventilated recesses.</li> <li>➤ Ensure sufficient ventilation for dispersal of the heat.</li> </ul>

Do not operate the constant climate chamber KBF / KBF P in hazardous locations.



	 <b>DANGER</b>
	<p><b>Explosion hazard.</b></p> <p><b>Danger of death.</b></p> <ul style="list-style-type: none"> <li>∅ Do NOT operate the unit in potentially explosive areas.</li> <li>∅ KEEP explosive dust or air-solvent mixtures AWAY from the unit.</li> </ul>

The constant climate chamber KBF / KBF P does not dispose of any measures of explosion protection.

	 <b>DANGER</b>
	<p><b>Explosion hazard.</b></p> <p><b>Danger of death.</b></p> <ul style="list-style-type: none"> <li>∅ Do NOT introduce any substance into the constant climate chamber which is combustible or explosive at working temperature.</li> <li>∅ NO explosive dust or air-solvent mixture in the inner chamber.</li> </ul>



Any solvent contained in the charging material must not be explosive or inflammable. I.e., irrespective of the solvent concentration in the steam room, NO explosive mixture with air must form. The temperature inside the chamber must lie below the flash point or below the sublimation point of the charging material. Familiarize yourself with the physical and chemical properties of the charging material, as well as the contained moisture constituent and its behavior with the addition of heat energy and humidity.



Familiarize yourself with any potential health risks caused by the charging material, the contained moisture constituent or by reaction products that may arise during the temperature process. Take adequate measures to exclude such risks prior to putting the constant climate chamber into operation.

	 <b>DANGER</b>
	<p><b>Electrical hazard.</b></p> <p><b>Danger of death.</b></p> <ul style="list-style-type: none"> <li>∅ The unit must NOT become wet during operation or maintenance.</li> </ul>

The constant climate chambers were produced in accordance with VDE regulations and were routinely tested in accordance to VDE 0411-1 (IEC 61010-1).

During and shortly after operation, the temperature of the inner surfaces almost equals the set-point.

	 <b>CAUTION</b>
	<p><b>The glass doors, the glass door handles, the inner chamber, and the light cassettes (KBF P) will become hot during operation.</b></p> <p><b>Danger of burning.</b></p> <ul style="list-style-type: none"> <li>∅ Do NOT touch the glass doors, the inner surfaces, the light cassettes or the charging material during operation.</li> </ul>

 	 <b>WARNING</b>
	<p><b>Stability hazard.</b></p> <p><b>Danger of injury.</b></p> <p><b>Damage to the unit and the charging material.</b></p> <p><b>Housing cover breakaway.</b></p> <ul style="list-style-type: none"> <li>∅ Do NOT climb on the lower housing cover.</li> <li>∅ Do NOT load the lower housing cover with heavy objects while the unit door is open.</li> </ul>



## 1.6 Intended use

Constant climate chambers series KBF / KBF P are suitable for exact conditioning of harmless materials. A mixture of any component of the charging material with air must NOT be explosive. The operating temperature must lie below the flash point or below the sublimation point of the charging material. Any component of the charging material must NOT be able to release toxic gases.

**Other applications are not approved.**

**Constant climate chambers series KBF / KBF P are not classified as medical devices as defined by the Medical Device Directive 93/42/EEC.**

	<p>Following the instructions in this operating manual and conducting regular maintenance work (chap. 16) are part of the intended use.</p>
---	---

 	 <b>DANGER</b>
	<p><b>Explosion or implosion hazard.</b></p> <p><b>Danger of poisoning.</b></p> <p><b>Danger of death.</b></p> <ul style="list-style-type: none"> <li>∅ Do NOT introduce any substance combustible or explosive at working temperature into the constant climate chamber.</li> <li>∅ NO explosive dust or air-solvent mixture in the inner chamber.</li> <li>∅ Do NOT introduce any substance which could lead to release of toxic gases.</li> </ul>

	<p>The charging material shall not contain any corrosive ingredients that may damage the machine components made of stainless steel, aluminum, and copper. Such ingredients include in particular acids and halides. Any corrosive damage caused by such ingredients is excluded from liability by BINDER GmbH.</p>
---	---





**WARNING:** If customer should use a BINDER chamber running in non-supervised continuous operation, we strongly recommend in case of inclusion of irrecoverable specimen or samples to split such specimen or samples and store them in at least two chambers, if this is feasible.

## 1.7 Operating instructions

Depending on the application and location of the unit, the operator of the constant climate chamber must provide the relevant information for safe operation of the unit in a set of operating instructions.



Keep these operating instructions with the unit at all times in a place where they are clearly visible. They must be comprehensible and written in the language of the employees.

## 1.8 Measures to prevent accidents

The operator of the constant climate chamber KBF / KBF P must observe the following rule: "Betreiben von Arbeitsmitteln. Betreiben von Kälteanlagen, Wärmepumpen und Kühleinrichtungen" (Operation of work equipment. Operation of refrigeration systems, heat pumps and refrigeration equipment) (GUV-R 500 chap. 2.35) (for Germany).

The manufacturer took the following measures to prevent ignition and explosions:

- **Indications on the type plate**  
See operating manual chap. 1.4.
- **Operating manual**  
An operating manual is available for each constant climate chamber.
- **Overtemperature monitoring**  
The constant climate chamber is equipped with a temperature display, which can be read from outside.  
The unit is equipped with an additional safety controller (temperature safety device class 3.1 acc. to DIN 12880:2007). Visual and audible (buzzer) signals indicate temperature exceeding.
- **Safety, measurement, and control equipment**  
The safety, measuring, and control equipment is easily accessible.
- **Electrostatic charge**  
The interior parts are grounded.
- **Non-ionizing radiation**  
Non-ionizing radiation is not intentionally produced, but released only for technical reasons by electrical equipment (e.g. electric motors, power cables, solenoids). The machine has no permanent magnets. If persons with active implants (e.g. pacemakers, defibrillators) keep a safe distance (distance of field source to implant) of 30 cm, an influence of these implants can be excluded with high probability.
- **Protection against touchable surfaces**  
Tested according to EN ISO 13732-1:2008.
- **Floors**  
See operating manual chap. 3.4 for correct installation
- **Cleaning**  
See operating manual chap. 16.3.

- **Examinations**

The constant climate chamber has been inspected by the "Deutsche Gesetzliche Unfallversicherung e.V. (DGUV) (German Social Accident Insurance (DGUV)" (German Social Accident Insurance (DGUV), Testing and Certification Body for Foodstuffs and Packaging Industry in DGUV Test) and bears the GS mark.

## 1.9 Resistance of the humidity sensor against harmful substances

The following list of harmful substances refers only to the humidity sensor and does not include any other materials incorporated in the unit or prohibited substances in relation to explosion protection.

Some gases - especially clean gases - do not have any influence on the humidity sensor. Others do have a very small influence, whereas others may influence the sensor to a larger extent.

- The following gases do not influence the sensor and the humidity measurement: Argon (Ar), carbon dioxide (CO<sub>2</sub>), helium (He), hydrogen (H<sub>2</sub>), neon (Ne), nitrogen (N<sub>2</sub>), nitrous oxide (N<sub>2</sub>O), oxygen (O<sub>2</sub>)
- The following gases do not, or to a minor extent influence the sensor and the humidity measurement: Butane (C<sub>4</sub>H<sub>10</sub>), ethane (C<sub>2</sub>H<sub>6</sub>), methane (CH<sub>4</sub>), natural gas propane (C<sub>3</sub>H<sub>8</sub>)
- The following gases do not, or to a minor extent influence the sensor and the humidity measurement, provided that the indicated loads are not exceeded:

		Maximum work place threshold limit value		Tolerated concentration with permanent load	
Substance	Formula	ppm	mg/m <sup>3</sup>	ppm	mg/m <sup>3</sup>
Ammonia	NH <sub>3</sub>	20	14	5500	4000
Acetone	CH <sub>3</sub> COCH <sub>3</sub>	500	1200	3300	8000
Benzene		300	1200		150000
Chlorine	Cl <sub>2</sub>	0.5	1.5	0.7	2
Acetic acid	CH <sub>3</sub> COOH	10	25	800	2000
Ethyl acetate	CH <sub>3</sub> COOC <sub>2</sub> H <sub>5</sub>	400	1400	4000	15000
Ethanol	C <sub>2</sub> H <sub>5</sub> OH	500	960	3500	6000
Ethylene glycol	HOCH <sub>2</sub> CH <sub>2</sub> OH	10	26	1200	3000
Formaldehyde	HCHO	0.3	0.37	2400	3000
Isopropanol	(CH <sub>3</sub> ) <sub>2</sub> CHOH	200	500	4800	12000
Methanol	CH <sub>3</sub> OH	200	260	3500	6000
Methyl ethyl ketone	C <sub>2</sub> H <sub>5</sub> COCH <sub>3</sub>	200	590	3300	8000
Ozone	O <sub>3</sub>	0.1	0.2	0.5	1
Hydrochloric acid	HCl	2	3	300	500
Hydrogen sulphide	H <sub>2</sub> S	10	15	350	500
Nitrogen oxides	NO <sub>x</sub>	5	9	5	9
Sulphur dioxide	SO <sub>2</sub>	5	13	5	13
Toluol	C <sub>6</sub> H <sub>5</sub> CH <sub>3</sub>	100	380	1300	5000
Xylene	C <sub>6</sub> H <sub>4</sub> (CH <sub>3</sub> ) <sub>2</sub>	100	440	1300	5000

These values are to be considered only as approximate values. The sensor resistance largely depends on the temperature and humidity conditions during the time of exposure to harmful substances. Avoid simultaneous condensation. Tolerated error of measurement: ± 2 %r.H. The maximum work place threshold limit value is one that can be regarded as harmless for humans.

- Vapors of oil and fat are dangerous for the sensor because they may condensate at the sensor and thus prevent its function (insulating layer). For similar reasons, it is not possible to measure smoke gases.

## 2. Unit description

Constant climate chambers KBF / KBF P are equipped with a multifunctional microprocessor display controller with 2-channel technology for temperature and humidity plus a digital display accurate to one-tenth of a degree resp. 0.1% r.H. With its comprehensive program control functions, the MB1 display controller permits the high precision performance of temperature and humidity cycles.

With its microprocessor controlled humidifying and dehumidifying system the KBF / KBF P is a high-precision constant climate chamber. It completely meets the requirements for climatic chambers of the stipulated stability and durability tests for pharmaceutical products:

- Stability tests acc. to ICH guideline CPMP/ICH/2736/99 (Q1A)
- Photostability tests acc. to ICH guideline CPMP/ICH/279/95 (Q1B) (KBF P)

Furthermore, it permits simulating exactly and over long periods constant conditions for other applications such as sample conditioning for material testing of paper, textiles, plastics, building materials, etc.

The APT.line™ preheating chamber system guarantees high level of spatial and time-based temperature precision, thanks to the direct and distributed air circulation into the interior. The fan supports exact attainment and maintenance of the desired temperature accuracy.

A resistance humidifying system humidifies the air. For this purpose, use deionized (demineralized) water. The option BINDER Pure Aqua Service allows using the chamber with any degree of water hardness.

The inner chamber, the pre-heating chamber, and the interior side of the doors are all made of stainless steel V2A (German material no. 1.4301, US equivalent AISI 304). The housing is RAL 7035 powder-coated. All corners and edges are also completely coated.

All unit functions are easy and comfortable to use thanks to their clear arrangement. Major features are easy cleaning of all unit parts and avoidance of undesired contamination.

The efficient program controller is equipped with a multitude of operating functions, in addition to recorder and alarm functions. Programming of test cycles is easily accomplished via the modern MB1 color-display controller and is also possible directly with a computer via Intranet in connection with the communication software APT-COM™ 3 DataControlSystem (option, chap. 15.1). Constant climate chambers KBF / KBF P come equipped with an Ethernet serial interface for computer communication.

In addition, the BINDER communication software APT-COM™ 3 permits networking up to 30 units and connecting them to a PC for controlling and programming, as well as recording and representing temperature and humidity data. For further options, see chap.19.5.

Constant climate chambers size 240, 720 and 1020 are equipped with four castors. Both front castors can be easily locked via the attached brakes.

The chambers can be operated in a temperature range from 0 °C / 32 °F up to 70 °C / 158 °F (KBF, KBF P without light cassettes) / from 10 °C / 50 °F up to 60 °C / 140 °F (KBF P with illumination) and in a humidity range of 10% r.H. to 80% r.H.

For the control ranges of temperature and humidity, see diagrams (chap. 12).

## 2.1 Unit overview

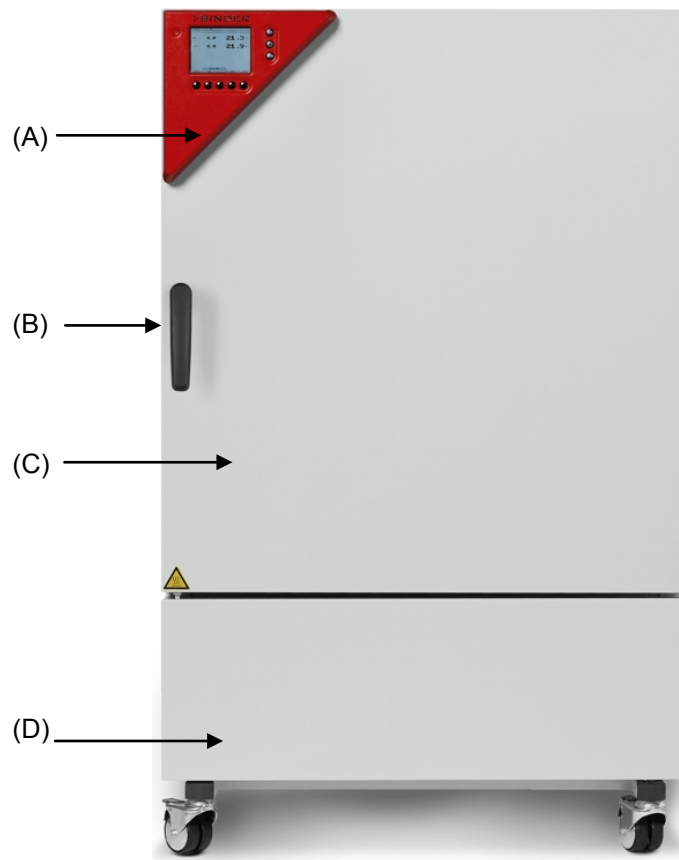

Figure 5: KBF 240

- (A) Instrument panel with MB1 display program controller
- (B) Door handle
- (C) Outer door
- (D) Refrigerating machine and humidity generation module

## 2.2 Instrument panel for KBF / KBF P

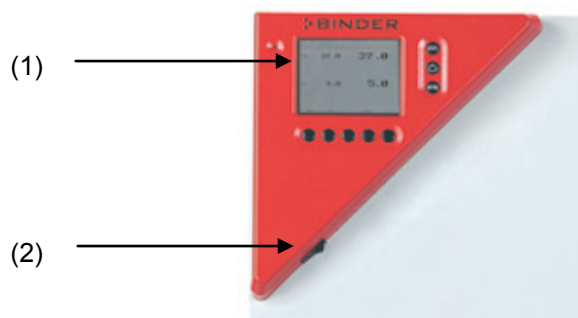

Figure 6: Triangle instrument panel

- (1) MB1 microprocessor program controller with 2-channel technology for temperature and humidity
- (2) Switch for interior lighting (option)

## 2.3 Lateral control panel, right side KBF / KBF P

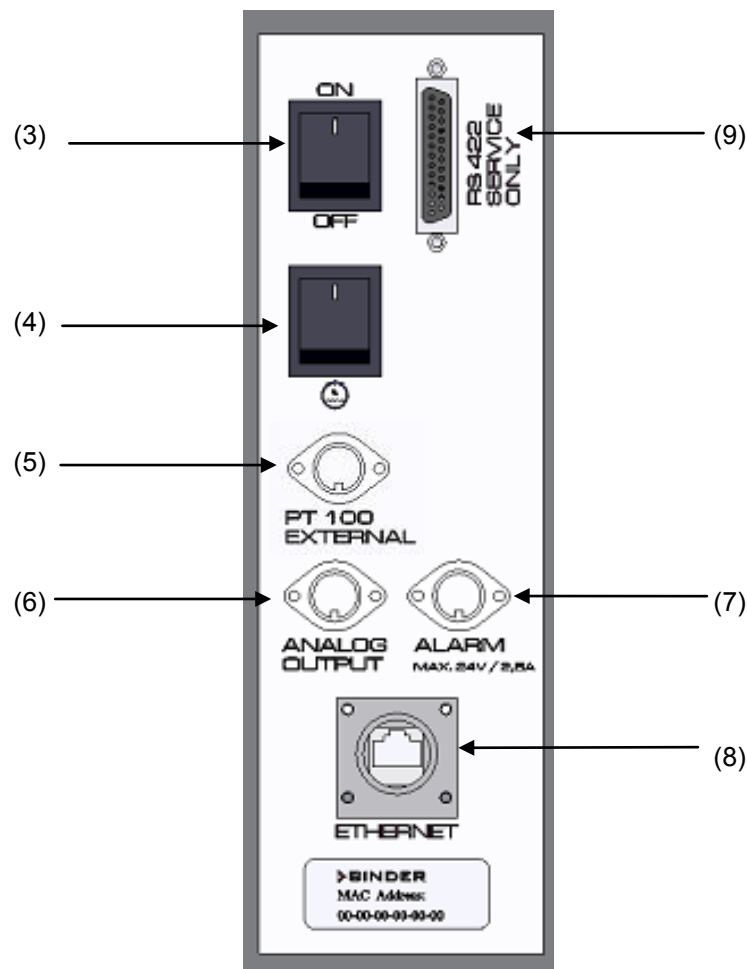

Figure 7: Lateral control panel KBF / KBF P at the right side of the humidity module with options analog outputs, alarm contact, and additional Pt 100 sensor

- (3) Main power switch ON/OFF
- (4) Humidity switch ON/OFF
- (5) DIN-socket additional Pt 100 temperature sensor (option)
- (6) DIN-socket analog outputs (option)
- (7) DIN-socket alarm contact (option)
- (8) Ethernet interface with indication of the MAC address for computer communication
- (9) RS422 interface (for service purpose only)

## 2.4 Lateral control panel, left side (KBF P, option KBF)

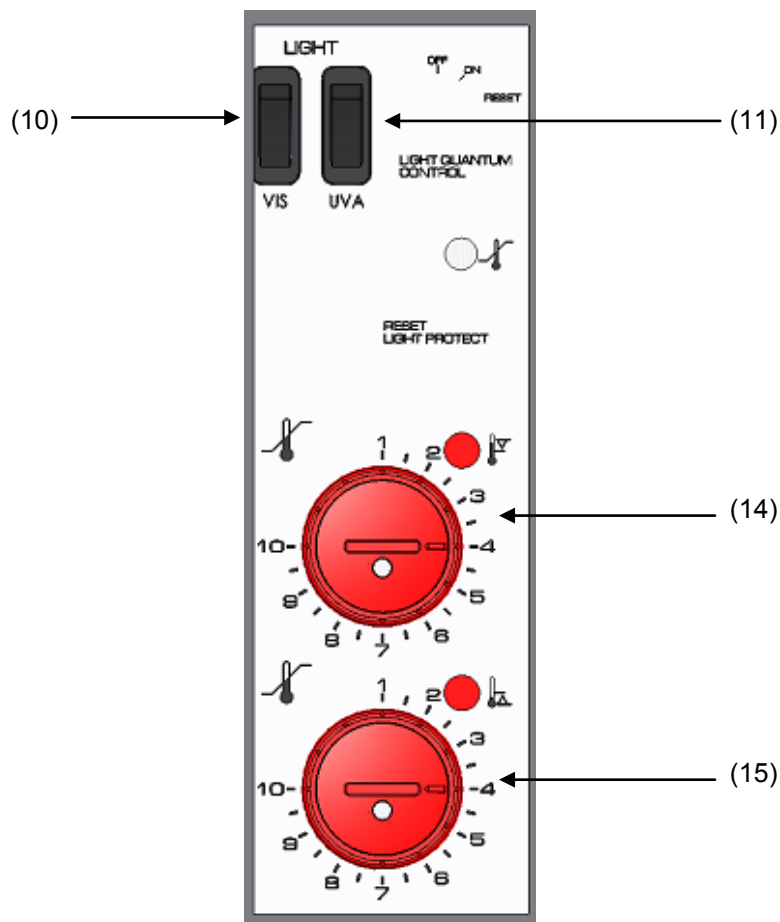

Figure 8: Lateral control panel KBF (option) / KBF P at the left side of the humidity module with option temperature safety device class 3.3

- (10) Switch for ICH compliant illumination cool white (KBF P)
- (11) Switch for ICH compliant illumination BINDER Q1B Synergy Light (UVA + cool white) (KBF P)
- (12) Not used
- (13) Not used
- (14) Temperature safety device class 3.1 (part of option safety device class 3.3)
- (15) Temperature safety device class 3.2 (part of option safety device class 3.3)

## 2.5 Rear view with water connections

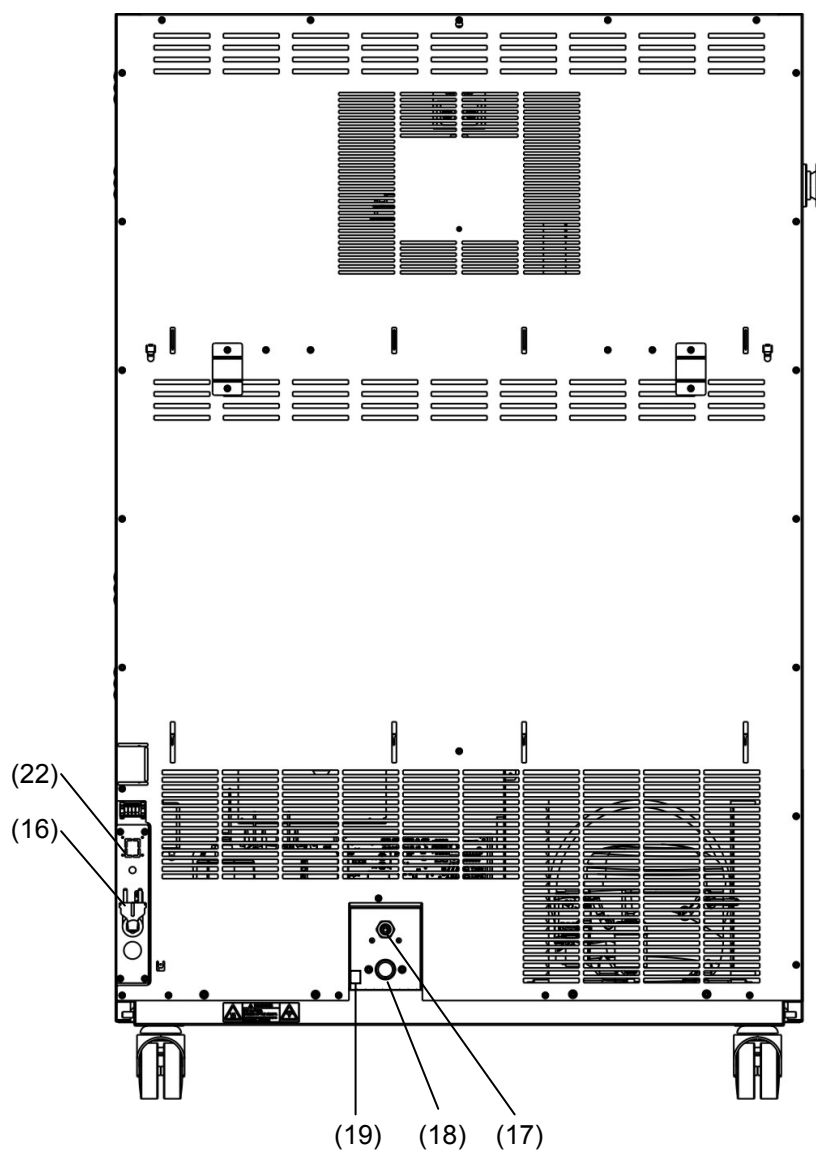

Figure 9: Rear view KBF / KBF P with water connections

- (16) Power cable
- (17) Wastewater connection "OUT" with hose olive for hose 1/2"
- (18) Freshwater connection "IN" with screw thread 3/4" for hose 1/2", with union nut
- (19) Purging outlet for humidifying module (KBF) – for service purpose only
- (22) Socket for optional freshwater can (chap. 15.9.1)





### 3. Completeness of delivery, transportation, storage, and installation

#### 3.1 Unpacking, and checking equipment and completeness of delivery

After unpacking, please check the unit and its optional accessories, if any, based on the delivery note for completeness and for transportation damage. Inform the carrier immediately if transportation damage has occurred.

The final tests of the manufacturer may have caused traces of the shelves on the inner surfaces. This has no impact on the function and performance of the unit.

Please remove any transportation protection devices and adhesives in/on the unit and on the doors and take out the operating manuals and accessory equipment.

   	 <b>CAUTION</b>
	<p><b>Sliding or tilting of the unit.</b></p> <p><b>Damage to the unit.</b></p> <p><b>Risk of injury by lifting heavy loads.</b></p> <ul style="list-style-type: none"> <li>⊘ Do NOT lift or transport the unit using the door, the handle, or the lower housing.</li> <li>➤ Lift units size 115 from the pallet at the four lower corners with the aid of four people</li> <li>➤ Lift units size 240 from the pallet at the four lower corners with the aid of six people or with a fork lifter. Set the fork lifter only from the front or rear in the middle of the unit.</li> <li>➤ Lift units size 720 and 1020 from the pallet using technical devices (fork lifter). Set the fork lifter only from the front or rear in the middle of the unit.</li> <li>⊘ Do NOT set the fork lifter from the unit side.</li> </ul>

If you need to return the unit, please use the original packing and observe the guidelines for safe lifting and transportation (chap. 3.2).

For disposal of the transport packing, see chap. 17.1.

#### Note on second-hand units (Ex-Demo-Units):





Second-hand units are units that were used for a short time for tests or exhibitions. They are thoroughly tested before resale. BINDER ensures that the chamber is technically sound and will work flawlessly.

Second-hand units are marked with a sticker on the unit door. Please remove the sticker before commissioning the unit.



### 3.2 Guidelines for safe lifting and transportation

The front castors of KBF / KBF P 240, 720 and 1020 can be blocked by brakes. Please move the units with castors only when empty and on an even surface, otherwise the castors may be damaged. After operation, please observe the guidelines for temporarily decommissioning the unit (chap. 17.2).

   	 <b>CAUTION</b>
<p><b>Sliding or tilting of the unit.</b>  <b>Damage to the unit.</b>  <b>Risk of injury by lifting heavy loads.</b></p> <ul style="list-style-type: none"> <li>➤ Transport the unit only in its original packaging.</li> <li>➤ For moving or shipping, secure the constant climate chamber with transport straps.</li> <li>⊘ Do NOT lift or transport the unit using the door, the handle, or the lower housing.</li> <li>➤ Lift units size 115 at the four lower corners with the aid of 4 people</li> <li>➤ Lift units size 240 at the four lower corners with the aid of 6 people or with a fork lifter. Set the fork lifter only from the front or rear in the middle of the unit.</li> <li>➤ Lift units size 720 and 1020 using technical devices (fork lifter). Set the fork lifter only from the front or rear in the middle of the unit.</li> <li>⊘ Do NOT set the fork lifter from the unit side.</li> </ul>	

You can order transport packing for moving or shipping purposes from BINDER service.

**Permissible ambient temperature range during transport:**

- If the steam humidifying system has NOT been emptied: +3 °C / 37.4 °F to +60 °C / 140 °F.
- After BINDER Service has emptied the steam humidifying system: -10 °C / 14 °F to +60 °C / 140 °F.

With temperatures below +3 °C / 37.4 °F, water must be completely removed from the humidifying system.

	<b>CAUTION</b>
<p><b>Transport below +3 °C / 37.4 °F with filled steam humidifying system.</b>  <b>Freezing in the steam generator.</b>  <b>Damage to the unit.</b></p> <ul style="list-style-type: none"> <li>➤ Contact BINDER Service before any transportation below +3 °C / 37.4 °F.</li> </ul>	

### 3.3 Storage

Intermediate storage of the unit is possible in a closed and dry room. Observe the guidelines for temporary decommissioning (chap. 17.2).

#### Permissible ambient temperature range during storage:

- If the steam humidifying system has NOT been emptied: +3 °C / 37.4 °F to +60 °C / 140 °F.
- After BINDER Service has emptied the steam humidifying system: -10 °C / 14 °F to +60 °C / 140 °F

With temperatures below +3 °C / 37.4 °F, water must be completely removed from the humidifying system.

	<b>CAUTION</b>
	<p><b>Storage below +3 °C / 37.4 °F with filled steam humidifying system.</b></p> <p><b>Freezing in the steam generator.</b></p> <p><b>Damage to the unit.</b></p> <p>➤ Contact BINDER Service before any transportation below +3 °C / 37.4 °F.</p>

#### Permissible ambient humidity: max. 70 % r.H., non-condensing

	<b>CAUTION</b>
	<p><b>Condensation by excess humidity.</b></p> <p><b>Danger of corrosion on the housing after operating at humidity values &gt; 70 % r.H. for a long period.</b></p> <p>➤ Dry the appliance completely before shut-down:</p> <ul style="list-style-type: none"> <li>• Set the humidity to 0 % r.H. and turn on humidity switch (4).</li> <li>• Set the temperature set point to 60 °C / 140 °F for approx. 2 hours (Manual mode).</li> <li>• Only then, shut down the unit at the main power switch (3) and close the tap of the water supply.</li> </ul>

When after storage in a cold location you transfer the unit to its warmer installation site, condensation may form. Before start-up, wait at least one hour until the chamber has attained ambient temperature and is completely dry.

In case of a prolonged temporal decommissioning: Leave the unit door open or remove the access port plugs.

### 3.4 Location of installation and ambient conditions

Set up the constant climate chamber on a flat, even surface, and in a well-ventilated, dry location and align it using a spirit level. The site of installation must be capable of supporting the unit's weight (see technical data, chap. 19.4). The chambers are designed for setting up inside a building (indoor use).

	<b>CAUTION</b>
	<p><b>Danger of overheating.</b></p> <p><b>Damage to the unit.</b></p> <p>∅ Do NOT set up unit in non-ventilated recesses.</p> <p>➤ Ensure sufficient ventilation for dispersal of the heat.</p>

- **Permissible ambient temperature range during operation:** +18 °C / 64.4 °F to +32 °C / 89.6 °F. At elevated ambient temperature values, fluctuations in temperature can occur.

	The ambient temperature should not be substantially higher than the indicated ambient temperature of +22 °C +/- 3°C / 71.6 °F ± 5.4 °F to which the specified technical data relate. Deviations from the indicated data are possible for other ambient conditions. Lower values are valid at an ambient temperature of max. 25 °C / 77 °F.
---	--

	With each degree of ambient temperature >25 °C / 77 °F, the refrigeration power decreases by 1.5 K.
---	---

- **Permissible ambient humidity:** 70 % r.H. max., non-condensing

When operating the chamber at temperature set-points below ambient temperature, high ambient humidity may lead to condensation on the unit.

- Installation height: max. 2000 m above sea level.

A water tap (1 bar to 10 bar / 14.5 to 145 PSI) is necessary for the installation of the humidification system (chap. 4.3). If no suitable in-house water connection is available, you can manually supply water by filling the freshwater can (option, chap. 15.9).

	To avoid any possible water damage, provide a floor drain at the location of the device. Select a suitable installation site to avoid any consequential damage by splashing water.
---	--

When placing several units of the same size side by side, maintain a minimum distance of 250 mm / 9.84 in between each unit. Wall distances: rear 100 mm / 3.94 in, sides 160 mm / 6.29 in. Spacing above the unit of at least 100 mm / 3.94 in, must also be accounted for.

	<b>CAUTION</b>
	<p><b>Danger by stacking.</b></p> <p><b>Damage to the units.</b></p> <p>⊘ Do NOT place constant climate chambers on top of each other.</p>



To completely separate the unit from the power supply, you must disconnect the power plug. Install the unit in a way that the power plug is easily accessible and can be easily pulled in case of danger.

For the user there is no risk of temporary overvoltages in the sense of EN 61010-1:2010.

With an increased amount of dust in the ambient air, clean the condenser fan (by suction or blowing) several times a year.

Avoid any conductive dust in the ambience according to the unit layout complying with pollution degree 2 (IEC 61010-1).

Do not install or operate the constant climate chamber KBF / KBF P in potentially explosive areas.

	 <b>DANGER</b>
	<p><b>Explosion hazard.</b></p> <p><b>Danger of death.</b></p> <p>⊘ Do NOT operate the unit in potentially explosive areas.</p> <p>➤ KEEP explosive dust or air-solvent mixtures AWAY from the vicinity of the unit.</p>

After turning off the unit, you must close the tap of the water supply. Install the unit in a way that the freshwater supply is easily accessible.

## 4. Installation and connections

### 4.1 Spacers for rear wall distance

Please fix both spacers with the supplied screws at the unit rear. This serves to ensure the prescribed minimum distance to the rear wall of 100 mm / 3.94 in.



Figure 10: Spacer for rear wall distance

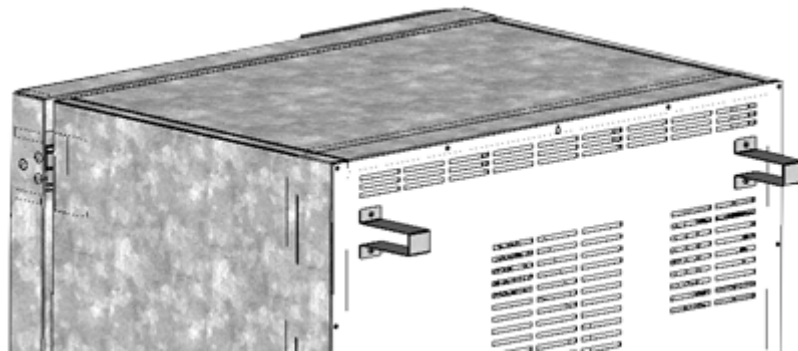

Figure 11: Rear KBF / KBF P with mounted spacers

### 4.2 Wastewater connection

Fasten the wastewater hose to the wastewater connection "OUT" (17) on the rear of the unit (olive  $\varnothing$  14 mm). Observe the following points:

- You can use a part of the supplied water hose as a drainage hose. In case another hose is used, it has to be permanently resistant against at least 95 °C / 203 °F.
- Mount the wastewater hose with a maximum positive inclination of 1 m / 3.28 ft and a maximum total length of 3 m / 9.8 ft.
- Protect the chamber end of the drainage hose with one of the supplied hose clamps
- Reliably prevent sucking back of wastewater. The end of the wastewater hose must not be immersed in liquids. This can be ensured e.g., by free discharge.



Wastewater is collected in an internal can with a volume of approx. 0.5 liters. It is pumped off only when required, thus there is no continuous wastewater flow.





Protect the wastewater supply with the supplied hose clamps.

### 4.3 Freshwater supply

	Connect the wastewater pipe before connecting the unit to a freshwater pipe or filling the freshwater can (option, chap. 15.9).
---	---

You can supply the unit with freshwater via a water pipe or by manually filling a freshwater can (option, chap. 15.9).

	Water intake temperature NOT below +5 °C / 41 °F and not exceeding 40 °C / 104 °F.
---	--

	<b>CAUTION</b>
	<p><b>Calcification of the humidifying system.</b></p> <p><b>Damage to the unit.</b></p> <p>➤ Operate the unit with deionized (demineralized) water only.</p>

#### Types of suitable water quality:

- Deionized water from a water treatment installation already existing at the customer's site. Conductivity from 1 µS/cm up to a maximum of 20 µS/cm. (Water, which is in equilibrium with the CO<sub>2</sub> in the air, and has a conductivity below 1 µS/cm (ultrapure water), may cause acid corrosion due to its low pH.)
- Water treated by the optional water treatment system BINDER Pure Aqua Service (disposable system). A reusable measuring equipment to assess the water quality is included (chap. 15.10).

	<p>BINDER GmbH is NOT responsible for the water quality at the user's site.</p> <p>Any problems and malfunctions that might arise following use of water of deviating quality is excluded from liability by BINDER GmbH.</p> <p>The warranty becomes void in the event of use of water of deviating quality.</p>
---	--

#### 4.3.1 Automatic freshwater supply via water pipe

An enclosure inside the unit contains the connection kit for freshwater and wastewater. Install the freshwater connection using either the enclosed water hose or another pressure-resistant one. To accomplish this, remove the cover of the freshwater connection "IN" (18) on the rear of the unit. Protect both ends of the hose with two of the four supplied hose clamps.

Before turning on the unit, check the connection for leaks. Water supply is automatically effected via the freshwater connection "IN" (18).

	As the appliance only lets in water when required, there is no continuous water flow.
---	---

	<ul style="list-style-type: none"> <li>• Supply pressure 1 to 10 bar / 14.5 to 145 PSI when connecting to a water pipe</li> <li>• Water type: deionized (demineralized) water</li> <li>• Water intake temperature NOT below +5 °C / 41 °F and not exceeding 40 °C / 104 °F.</li> <li>• The water intake should be provided with a shut-off slide or water-tap.</li> <li>• For the water supply, fix the delivered adapter with hose olive on the thread at the rear of the chamber.</li> <li>• Protect the water supply at one side with the supplied hose clamp.</li> </ul>
---	--

### 4.3.2 Manual freshwater supply via external freshwater can (option)

If no house water connection with suitable water is available, you can manually supply water by filling a freshwater can (option, volume: 20 liters / 0.71 cu.ft. You can attach the freshwater can on the rear of the unit or place it next to the unit (chap. 15.9).



To guarantee humidification during 24 hours even at high humidity set-points with manual water supply, we recommend filling the freshwater can (option) daily at the end of the day.

### 4.3.3 Connection kit for connecting the unit to the water main

A safety kit against flooding caused by burst water hoses is enclosed with the constant climate chamber. It consists of the following:

- Hose burst protection device
- 2 hose nozzles with screwing
- 4 hose clamps
- 6m water hose, divisible for the feed hose and drain

#### Protection principle of hose burst protection:

Whenever a strong water flow of about 18 l / min. occurs, e.g. caused by a burst water hose, a valve automatically cuts off the water supply, which can be heard as a clicking noise. The water supply now remains shut until it is manually released.

#### Assembly:

Screw the hose burst protection device onto a water tap with a G<sup>3</sup>/<sub>4</sub> inch right turning thread connection. The connection is self-sealing. Establish the connection between the safety kit and the chamber with a part of the supplied hose. Protect both ends of the hose by the supplied hose clamps.

We recommend connecting the hose as the last step in order to avoid twisting the hose while screwing on the safety kit.

Open the water tap slowly in order to avoid actuating the hose burst protection device.

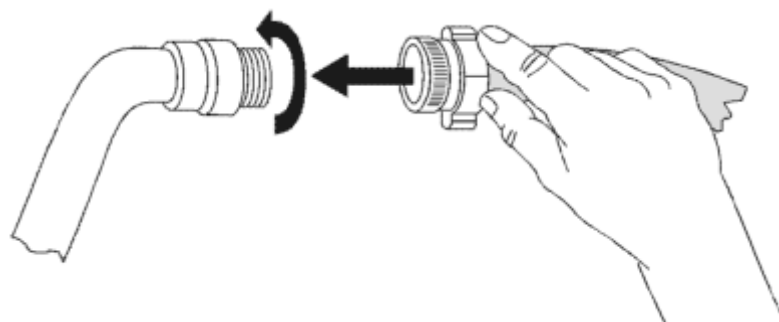



Figure 12: Assembly of the connection kit

#### Release of the reflux protection device:

In case the burst protection device has interrupted the water supply, first find the reason and remove it as necessary. Close the water tap. Release the valve by a half left-turn of the upper knurled part. You can hear the release of the valve as a clicking noise. Tighten the burst protection device against the water tap by a right turn. Open the water tap slowly afterwards.

### Maintenance of the assembly of the hose burst protection device:

Calcification can impair valve function. We recommend an annual inspection by a skilled plumber. The plumber should demount the safety kit to check the valve by hand for proper function, calcification or blockage.

	<b>CAUTION</b>
	<p><b>Danger of calcification.</b></p> <p><b>Impairment of valve function.</b></p> <ul style="list-style-type: none"> <li>➤ Have a plumber inspect the valve annually.</li> <li>➤ Remove calcifications by citric acid or acetic acid solutions.</li> <li>➤ Continue by testing the function and tightness of the mounted unit</li> </ul>

Check: Quickly open the water tap while there is no chamber connected – the valve should cut off the water flux without any delay.

#### 4.3.4 Safety kit: Hose burst protection device with reflux protection device (available via BINDER INDIVIDUAL customized solutions)

A safety kit with a reflux protection device is available for protection of the drinking water system, acc. to DIN 1988 part 4, and against flooding caused by burst water hoses.

##### Protection principles:

Whenever a strong water flow of about 18 l / min. occurs, e.g. caused by a burst water hose, a valve automatically cuts off the water supply, which can be heard as a clicking noise. The water supply now remains shut until it is manually released.

A possible endangering of the drinking water system depends on the risk potential of the charging material. Under unfavorable conditions (e.g. decreasing pressure inside the tap water system), drained off charging material could be sucked out of the chamber via the steam generator into the tap water system and therefore contaminate the drinking water. According to standard DIN 1988, part 4, the safety kit with a reflux protection device provides security in case of short-term utilization of substances with low risk potential. When using substances bearing a higher risk potential, install a pipe disconnecter to assure absolute protection. It is the user's responsibility to prevent (according to national standards) any reflux of contaminated water from getting into the drinking water system.

##### Assembly:

The standard supplied parts – hose burst protection device, hose nozzle with screwing – are not needed.

Screw the pre-mounted assembly of the hose burst protection and reflux protection devices onto a water tap with a G $\frac{3}{4}$  inch right turning thread connection. The connection is self-sealing. Establish the connection between the safety kit and the chamber with a part of the supplied hose. Protect both ends of the hose with the supplied hose clamps.

We recommend connecting the hose as the last step in order to avoid twisting it while screwing on the safety kit.

Open the water tap slowly in order to avoid actuating the hose burst protection device.

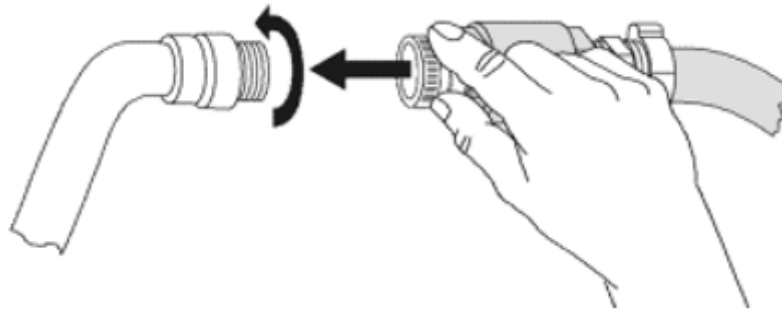



Figure 13: Assembly of the safety kit (hose burst protection and reflux protection devices)

**Release of the reflux protection device:**

In case the hose burst protection device interrupts the water supply, first find the reason and remove it as necessary. Close the water tap. Release the valve by a half left-turn of the upper knurled part. You can hear the release of the valve as a clicking noise. Tighten the burst protection device against the water tap by a right turn. Open the water tap slowly afterwards.

**Maintenance of the assembly of hose burst protection and reflux protection devices:**

Calcification can impair the function of both valves. We recommend an annual inspection by a skilled plumber. The plumber should remove the safety kit with the reflux protection device to check both valves by hand for proper function, calcification or blockage.

	<p><b>CAUTION</b></p>
	<p><b>Danger of calcification.</b>  <b>Impairment of valve function.</b></p> <ul style="list-style-type: none"> <li>➤ Have a plumber inspect the two valves annually.</li> <li>➤ Remove calcifications by citric acid or acetic acid solutions.</li> <li>➤ Continue by testing the function and tightness of the mounted unit.</li> </ul>

Check: Quickly open the water tap while there is no chamber connected – the valve should cut off the water flux without any delay.



#### 4.4 Installation and connection of the light cassettes (KBF P)

You can insert the light cassettes in different heights onto the beads at the lateral walls of the unit. Insert and pull out the light cassettes only by the handles.

Connect the cables of the light cassettes to its closest connection socket at the right side in the back of the chamber.

Put the waterproof plug on the connection socket. When the plug has engaged, turn the locking-nut of the plug several times to the right up to its final stopping point. The plug is now automatically sealed into the socket.

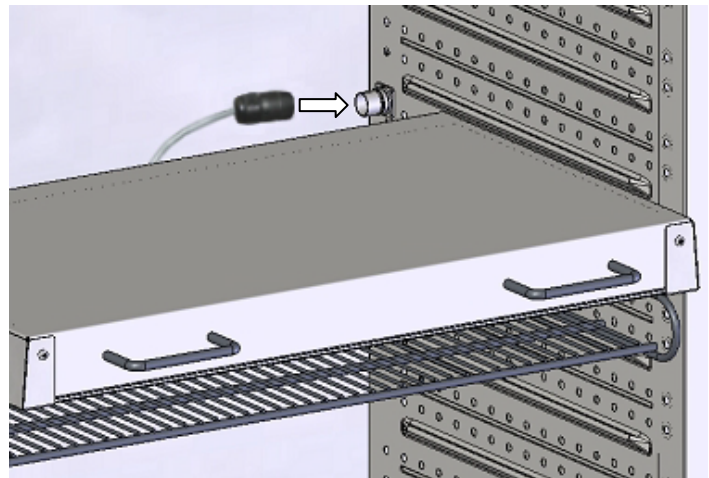

Figure 14: Connecting the light cassettes



Use the covers supplied to protect any unused connection socket.

Do not place any charging material directly onto the light cassettes because those are heated by the fluorescent tubes which would lead to exposing the charging material to undefined temperatures. The temperature directly below or on the light cassettes is not equal to the temperature displayed at the temperature controller.



Place the charging material on the supplied racks below the light cassettes.



**The light cassettes will become hot with temperature set-points >40 °C.**

**Danger of burning.**

- ⊘ Do NOT touch the light cassettes during operation.
- Let the light cassettes cool down before changing their position.



When operating the chamber at temperatures > 60 °C / 140 °F, remove the light cassettes. Otherwise, the life expectancy of the fluorescent tubes will be considerably reduced.

## 4.5 Electrical connection

The constant climate chambers are supplied ready for connection. The constant climate chamber comes with a fixed power connection cable that has a length of 1800 mm / 5.9 ft.

Model	Power plug	Voltage +/-10% at the indicated power frequency	Current type	Unit fuse
KBF 115 KBF 240 KBF 720 KBF 1020 (model version KBF1020-230V) KBF P 240 KBF P 720	Shock-proof plug	200-230 V at 50 Hz 200-230 V at 60 Hz	1N~	16 A
KBF 115-UL KBF 240-UL KBF 720-UL KBF 1020 (model version KBF1020-240V) KBF P 240-UL KBF P 720-UL	NEMA 6-20P	200-240 V at 50Hz 200-240 V at 60Hz	2~	16 A



- The socket must also provide a protective conductor.
- Prior to connection and start-up, check the power supply voltage. Compare the values to the specified data located on the unit's type plate (left unit side, bottom right-hand, see chap. 1.4).
- When connecting, please observe the regulations specified by the local electricity supply company and as well as the VDE directives (for Germany). We recommend the use of a residual current circuit breaker.
- Pollution degree (acc. to IEC 61010-1): 2
- Installation category (acc. to IEC 61010-1): II

	<b>CAUTION</b>
	<p><b>Danger of incorrect power supply voltage.</b> <b>Damage to the equipment.</b></p> <ul style="list-style-type: none"> <li>➤ Check the power supply voltage before connection and start-up.</li> <li>➤ Compare the power supply voltage with the data indicated on the type plate.</li> </ul>

See also electrical data (chap. 19.4).

	<p>To completely separate the unit from the power supply, you must disconnect the power plug. Install the unit in a way that the power plug is easily accessible and can be easily pulled in case of danger.</p>
---	--

**Remark when operating with a power frequency of 60 Hz:**



	 <b>WARNING</b>
	<p><b>High leakage current.</b> <b>Electrical hazard.</b></p> <ul style="list-style-type: none"> <li>➤ Earth connection essential before connecting supply. Check socket before inserting plug.</li> </ul>

When connected to a power supply 1N~ with a frequency of 60 Hz, a leakage current of more than 3.5 mA is possible. If grounding through the power cable is insufficient or missing, the leakage current may flow through the user's body. Correct installation of the professional grade power socket provided by the user safely avoids this. Before connecting the unit to the socket, please check its grounding contact type plug for appropriate construction and if it is undamaged.

#### 4.6 Connection of the voltage changer (option for KBF P 240 and KBF)

The voltage changer enables the constant climate chamber to operate at a power frequency of 115 Volt. It is packed separately and supplied together with the constant climate chamber.

The voltage changer is supplied with a fixed power connection cable with a NEMA 5-20P plug. It is protected against excess-current with an internal over-current release category B16A. The connection is made by the customer.

 	 <b>CAUTION</b>
	<p><b>Sliding or tilting of the voltage changer.</b>  <b>Damage to the voltage changer.</b>  <b>Risk of injury by lifting heavy loads.</b></p> <ul style="list-style-type: none"> <li>➤ Lift the voltage changer at both carrying handles from the pallet with two persons.</li> </ul>

Do not install the voltage changer in the exhaust air flow at the rear of the constant climate chamber.

For the installation of the voltage changer next to the constant climate chamber, provide a wall distance the alternating climate chamber of approx. 0.4 m / 1.3 ft.

	<b>CAUTION</b>
	<p><b>Danger of overheating.</b>  <b>Damage to the voltage changer.</b></p> <ul style="list-style-type: none"> <li>⊘ Do NOT install the voltage changer in unventilated recesses.</li> <li>➤ Ensure sufficient ventilation for dispersal of the heat.</li> </ul>

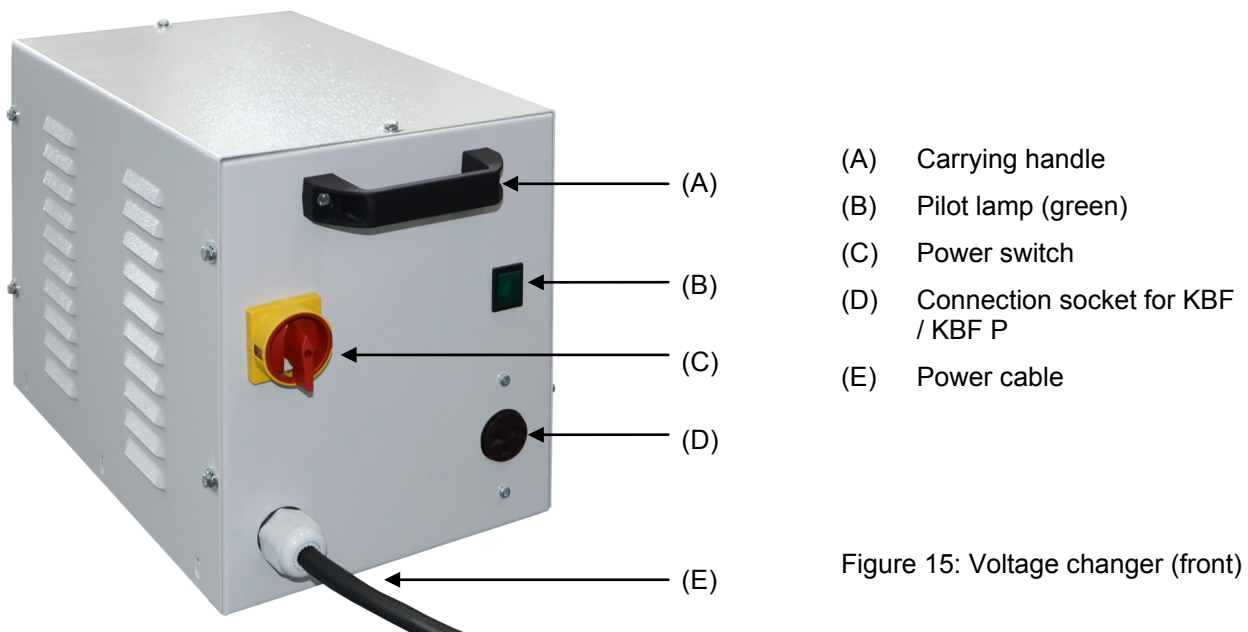
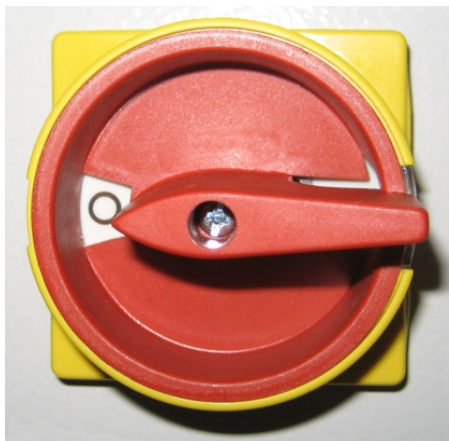

Figure 15: Voltage changer (front)

To establish the electrical connection of the constant climate chamber with the voltage changer, proceed in the following order:

1. Connect the power cable of the KBF / KBF P to the connection socket (D) of the voltage changer
2. Establish the power connection of the voltage changer. The socket must provide a protective conductor.
3. Turn on the voltage changer at the power switch (C) (position "I"). The green pilot lamp (B) lights up.
4. Turn on the constant climate chamber with the main power switch (3) in the lateral control panel



Position "0" = off

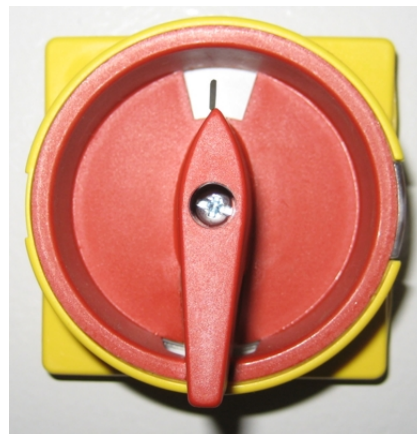

Position "I" = on

Figure 16: Power switch of the voltage changer

<b>Dimensions of the voltage changer</b>		
Height	mm	255
Depth (without door handles)	mm	360
Depth (incl. cable and door handles)	mm	450
Height	mm	300
Length of the connection cable to wall socket	mm	172
Lateral wall clearance of the constant climate chamber to set up the voltage changer (minimum)	mm	400
<b>Electrical connection data of the voltage changer</b>		
Input side	V	115
	A	26,9
Output side (to the chamber)	V	214
	A	13,0
Power frequency	Hz	50 / 60

## 5. Start up

- After connecting the supply lines (chap. 4), turn on the unit via the main power switch (3).
- Open the water-tap for freshwater supply. Alternatively, fill the freshwater can (option, chap. 15.9).
- Turn on the humidifying and dehumidifying system with switch (4) (humidity switch ON/OFF).

After the first turning on of the chamber or after an interruption of the power supply the relative humidity will increase after a delay of about 20 minutes. During this period, the relative humidity can drop considerably.

Warming chambers may release odors in the first few days after commissioning. This is not a quality defect. To reduce odors quickly we recommend heating up the chamber to its nominal temperature for one day and in a well-ventilated location.



**WARNING:** If customer should use a BINDER chamber running in non-supervised continuous operation, we strongly recommend in case of inclusion of irrecoverable specimen or samples to split such specimen or samples and store them in at least two chambers, if this is feasible.

### 5.1 Function overview of the MB1 display program controller

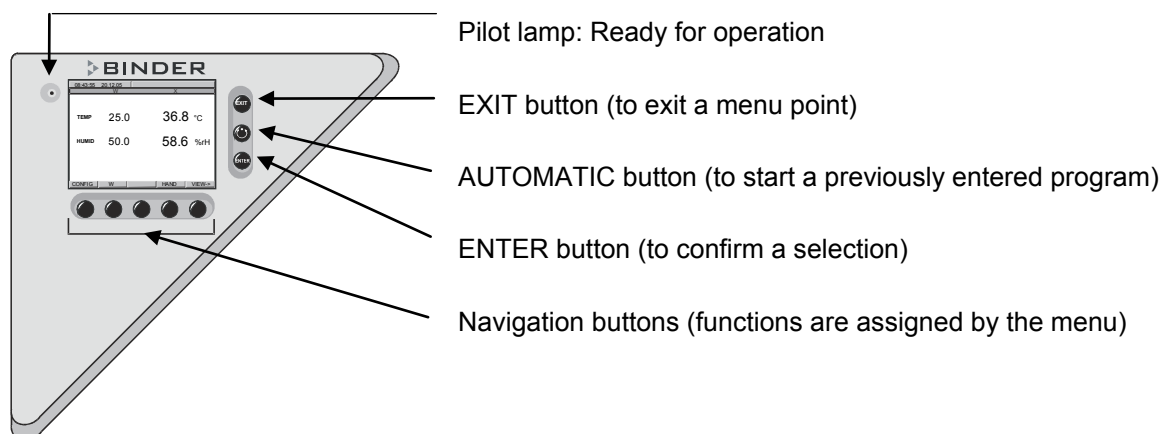

Figure 17: MB1 temperature and humidity program controller

The MB1 2-channel program controller controls following values inside the constant climate chamber:

Channel 1: Temperature in °C (range without humidity / without light cassettes: 0 °C / 32 °F to 70 °C / 158 °F)

Channel 2: Relative humidity in % r.H. (range 10 % r.H. to 80 % r.H.)

You can enter the desired set point values in Manual Mode or Program Mode (chap. 5.2) in the display controller. For the control range of temperature and relative humidity, see chap. 12).

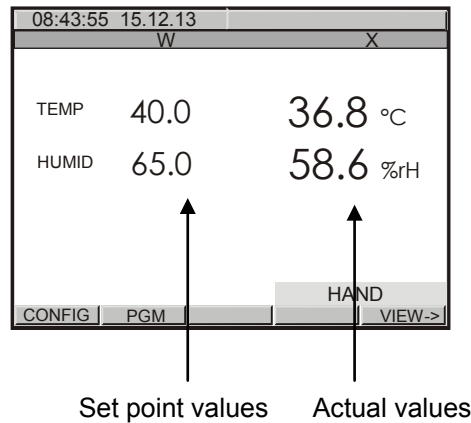

Figure 18: Normal display of the MB1 program controller in Manual mode

## 5.2 Operating modes

The MB1 2-channel program controller operates in 3 modes:

<b>Idle Mode</b>	The controller is not functional, i.e., there is no heating or refrigeration and no humidification or dehumidification. The fan turns at a 50% rate.
<b>Manual Mode (Fixed value operation) (HAND)</b>	The controller operates as a fixed-point control, i.e., set-points for temperature and humidity can be defined, which are then maintained (chap. 8).
<b>Program Mode (AUTO)</b>	An entered temperature and humidity program is run (chap. 9).

The MB1 program controller permits programming temperature and humidity cycles.

The controller offers 25 program memory positions with 100 program sections each. The total number of program sections of all programs is limited to 500.

Programming can be done directly through the keypad of the controller or graphically through the software APT-COM™ 3 DataControlSystem (option, chap. 15.1) specially developed by BINDER.

## 5.3 Performance after power failures

After the power returns, the unit continues to function in the original operating mode it was in previously before an actual power failure had occurred. In Manual Mode (HAND), the controller regulates temperature and humidity to the last entered set-points, while in Program Mode (AUTO) it regulates temperature and humidity to their set-points that were reached during the program operation. The power failure is noted in the event list (chap. 6.2) however, no error message is displayed indicating that a power failure has taken place.

## 5.4 Turning on the unit

Set the main power switch (3) to position I. The pilot lamp shows the unit is ready for operation.



Observe a delay time of about 30s between turning Off and On again. Otherwise an initialization problem may occur (display showing e.g. “-1999”).

Note that the chamber is in stand-by mode when the main power switch is in position I and the controller display is dark. Turn on the unit by pressing any button. When turned on, the unit functions in the operating mode entered before turning off. In Manual Mode (HAND), the controller regulates temperature and humidity to the last entered set-points, and in Program Mode (AUTO) it regulates temperature and humidity to their set-points reached during the previous program operation.

### Structure of toggling between Idle Mode / Manual Mode / Program Mode:

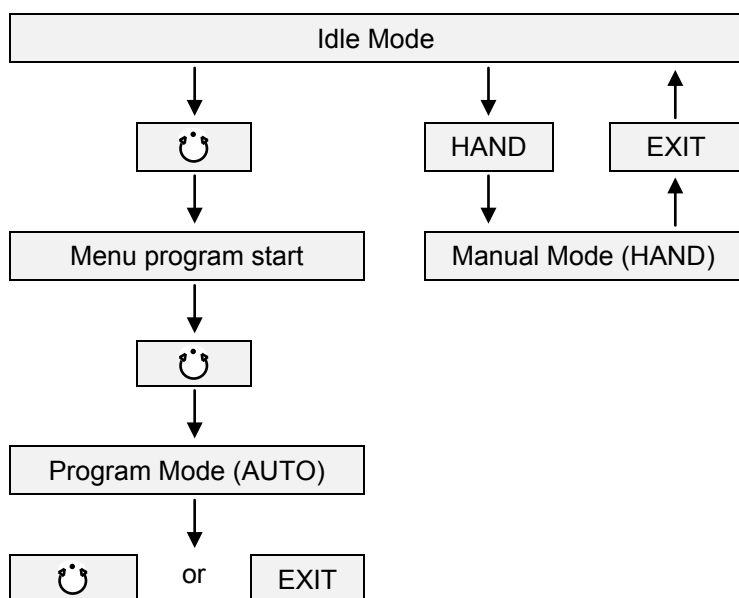

## 6. MB1 controller settings

### 6.1 Selection of the MB1 controller's menu language

The MB1 display program controller controls the temperature and humidity inside the constant climate chamber. The controller communicates by a menu guide using real words in German, English and French.

The selection of the desired menu language is located in the sub-menu "User-Level" of the "User-Settings" menu. Select menu point "Language".

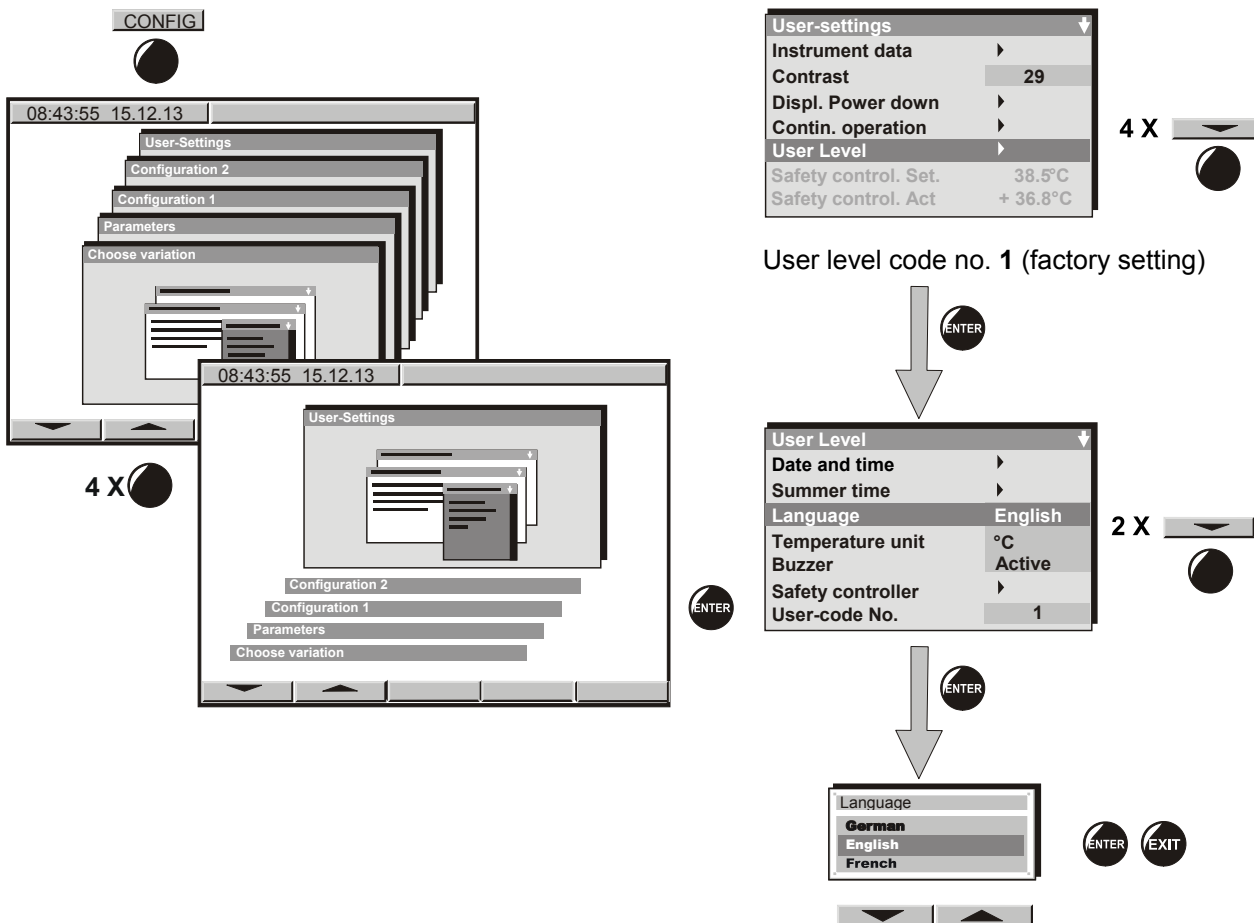

The row of buttons below the display is context-sensitive. The inscription above the buttons on the display defines the button's function.

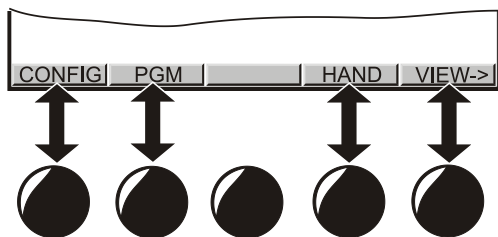

Do NOT change the temperature unit from °C to °F.



## 6.2 Function overview of the MB1 program controller displays

The main operation level contains the following different displays:

- **Normal display** (Idle Mode or Manual Mode or Program Mode)
- **Event List**
- **Chart recorder function**
- **Contact page**

Button **VIEW->** permits toggling between the displays.

The **Normal display** enables comparison of the current temperature and humidity (W) to the set-point values (X) or shows the fan working rate.

### CONTACT PAGE



BINDER Service contact display.

### NORMAL DISPLAY Idle Mode

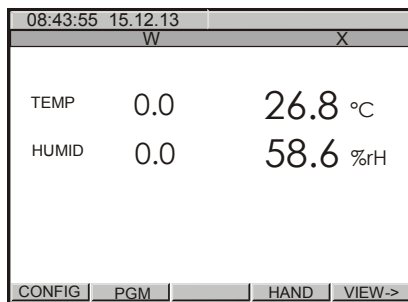

or

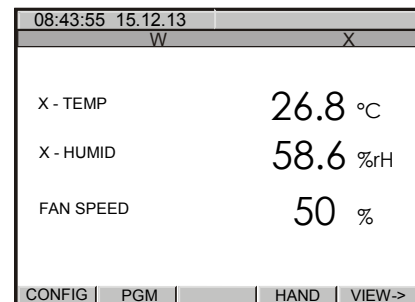

No heating or refrigeration, no humidification or dehumidification. The actual values (X) approximate ambient temperature and humidity. Fan operates at a 50% rate.

### NORMAL DISPLAY Manual Mode

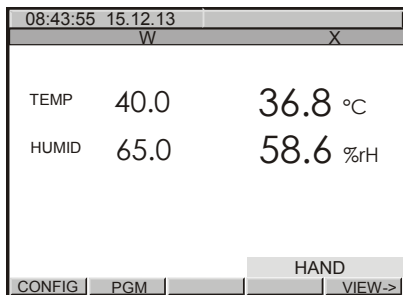

Temperature and humidity values are maintained according to the previous entered set-points (W).

### NORMAL DISPLAY Program Mode

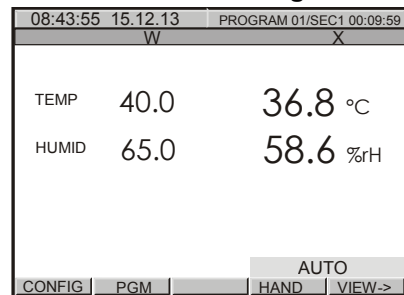

A temperature and humidity program entered before via a program table is run.

### EVENT LIST

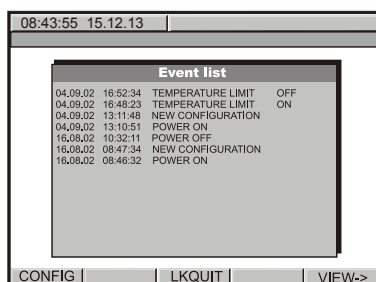

Overview over the last 16 events or error occurrences of the unit.

### CHART RECORDER FUNCTION

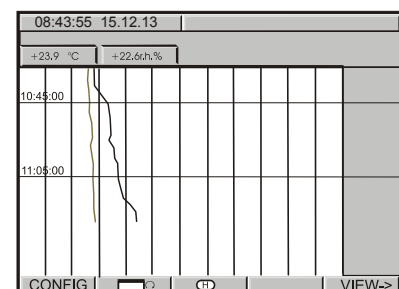

Graphical display of the current temperature and humidity values and review of the previous measurements on a historical display. A memory interval of 5s corresponds to a supervision period of 2.5 days.

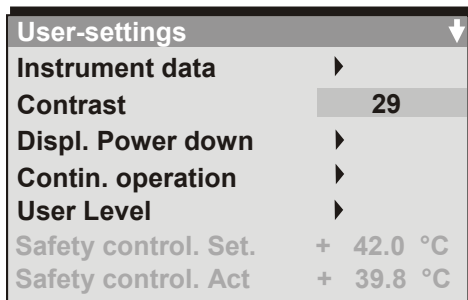

### 6.3 Menu settings in the “User-settings” menu

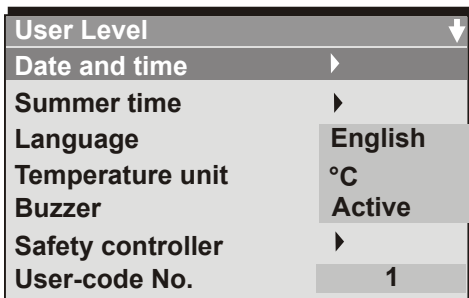

<b>Instrument data</b>	<p><b>Instrument Name</b></p> <p>Enter an individual name of the constant climate chamber.</p> <p><b>Address</b></p> <p>Enter a controller address (1 to 30) for operation with the communication software APT-COM™.</p> <p>All other entries are relevant only for service purposes.</p>
<b>Contrast</b>	(no function)
<b>Displ. power down</b>	<p><b>Switch off event</b></p> <p>Do not change the entry “Wait. Period”.</p> <p><b>Waiting period</b></p> <p>You can enter a delay time after which the display, following manual activation, will automatically be turned off. This happens when the moment is outside the operation time defined in menu “Contin. operation”.</p>
<b>Contin. operation</b>	Enter an operation time to determine the period of display activity. Outside the defined time, the display is automatically turned off. Pressing down any key will reactivate the display. After the time set in menu “Displ. power down”, the display will turn off again when the actual time is not within the operation time fixed in menu “Cont. operation”.
<b>User Level</b>	Toggle here to the display menu “User Level” (chap. 6.4) by entering a password. Factory default setting for this password is +00001. You can change the password (“user code”) in the menu “User Level”.
<b>Safety control.Set</b>	The setting of the tolerance limit of the safety controller (chap. 10.2) is displayed. You cannot change it in this view.
<b>Safety control.Act</b>	The measuring result of the safety controller (chap. 10.2) is displayed. The safety controller compares the value measured by a second independent temperature sensor to the entered tolerance limit.

## 6.4 Menu settings in the “User Level” menu



<b>Date and time</b>	Enter the actual date and time to provide the proper measurement records. Data is displayed in the chart recorder function (chap. 7) of the controller and will remain stored in case of a power failure.	
<b>Summer time</b>	Time is set one hour in advance during the summer time period. Setting the summer time switch: <ul style="list-style-type: none"> <li>• <b>Off:</b> No change to summer time occurs</li> <li>• <b>User timed:</b> Beginning and end of summer time can be set individually</li> <li>• <b>Automatic:</b> The summer time arrangement for central Europe is enabled (summer time from last Sunday of March until last Sunday of October)</li> </ul>	
<b>Language</b>	Select the menu language as German, English, or French (chap. 6.1).	
<b>Temperature unit</b>		Do NOT change the temperature unit from °C to °F.
<b>Buzzer</b>	Audible alarm buzzer <b>Inactive:</b> No audible alarm will sound if an alarm event happens (chap. 11). <b>Active:</b> An audible alarm will sound in case of an alarm event (chap. 11).	
<b>Safety controller</b>	Enter a safety controller tolerance limit to prevent temperature from exceeding this setting. For setting, see chap. 10.2.	
<b>User-Code No.</b>	Change the password (“user code”) needed to access the menu “User level”. Factory default setting +00001.	
		Keep in mind any modification of the user password. There is no access to this menu without the correct password.

## 7. Graphic representation of the historical measurement (chart recorder function)

The representation of data imitates a chart recorder and allows recalling any set of measured data at any point of time taken from the recorded period.

Normal display of the chart recorder function: Top left: The actual date and time are displayed.

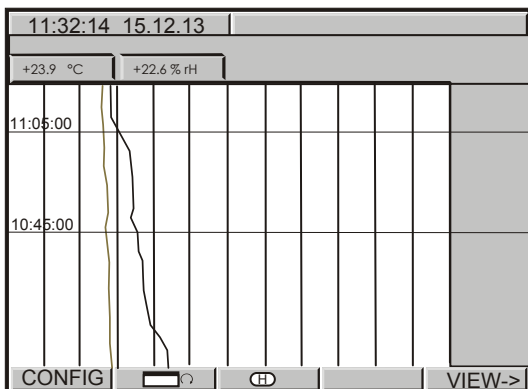

Below: The current values of temperature [ °C] and humidity [% r.H.] are numerically and graphically displayed.

Scaling:

**Temperature:** -10 °C / 14 °F to 100 °C / 212 °F

**Humidity:** 0% r.H. to 100% r.H.

Button permits toggling between different representations.

Depending on the selected kind of representation, button might not have been visible until this procedure.

History display with cursor:

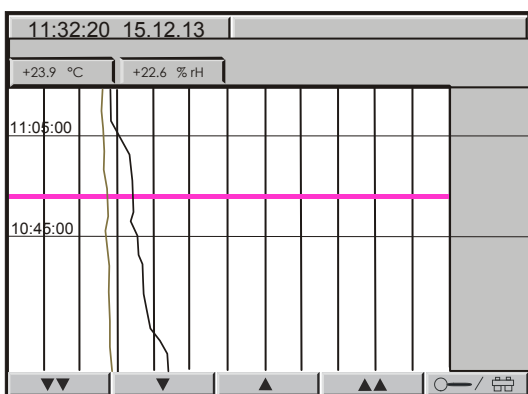

Select button = History. A pink line appears on the display marking as a cursor the selected moment. You can now recall the recorded data of any defined moment.

Top left: Date and time of the selected cursor position are displayed.

Below: The corresponding temperature and humidity values of this instance are numerically and graphically displayed.

Scroll the cursor position using the arrow buttons.

Single arrow buttons: fine-tuning.

Double arrow buttons: page-up and page-down.

Toggle to the zoom display by pressing button :

History - zoom function

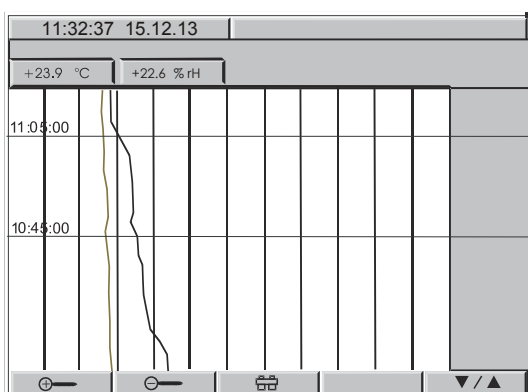

Magnifier buttons : Zoom and zoom back (i.e., shorten or extend the displayed period).

Toggle back to the former representation display using this button .

You can also directly enter any cursor position as a numerical input.

History representation: Toggling to any defined moment:

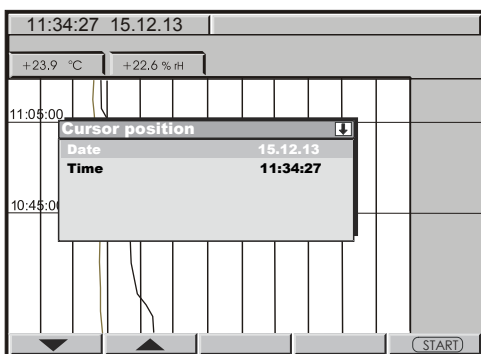

Press button . The window "Cursor position" opens to enter date and time.

Select date or time with the arrow buttons and confirm with ENTER.

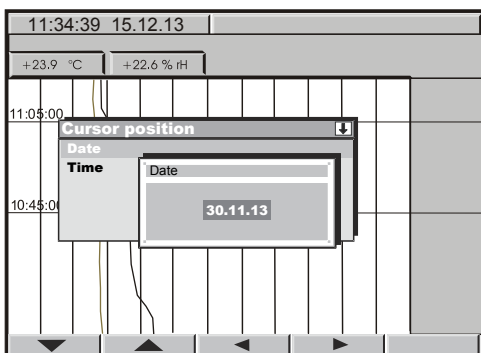

Now you can access any moment that you would like to recall. Enter date and time with the arrow buttons and confirm with ENTER.

Press button .

History display at the selected point of time:

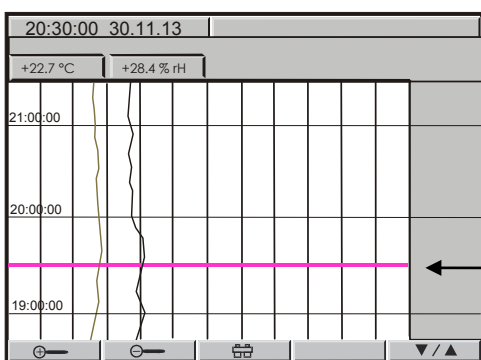

Top left: Date and time of the selected cursor position are displayed.

Below: The corresponding temperature and humidity values of this moment are numerically and graphically displayed.

The cursor line marks the corresponding moment.

The available presentation depends on the pre-selected storage rate. This means the higher the storage rate, the more precisely but shorter the data representation will be, see table below:

Storage rate	Storage duration	
	(hours)	(days)
5 sec	60	2,5
10 sec	120	5
1 min	720	30
5 min	3600	150
10 min	7200	300



### CAUTION

**Setting the storage rate clears the measured-value memory.**

**Danger of information loss.**

➤ Change the storage rate **ONLY** if the previously registered data is no longer needed.

## 7.1 Setting the storage rate

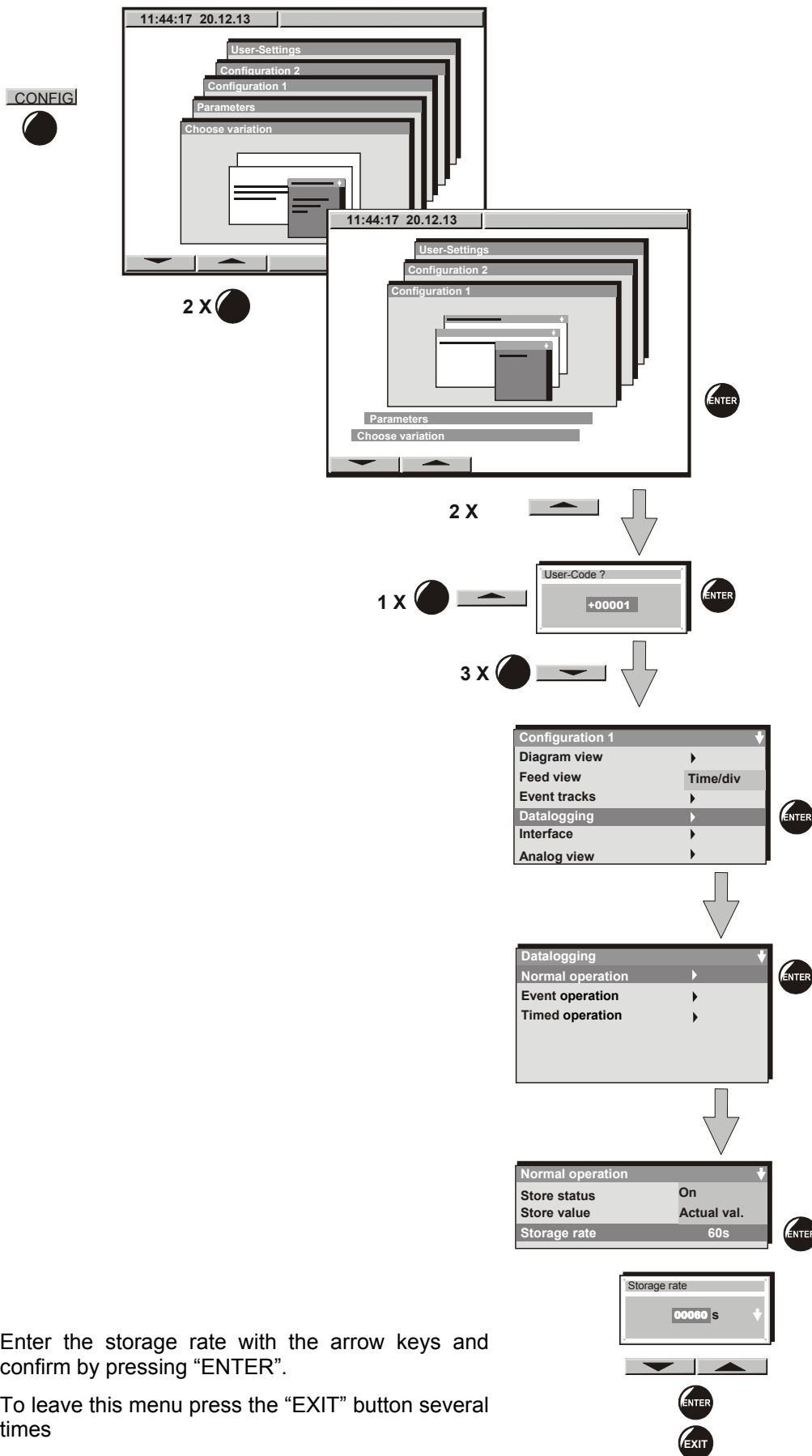

Enter the storage rate with the arrow keys and confirm by pressing “ENTER”.

To leave this menu press the “EXIT” button several times

## 8. Manual Mode

In Manual Mode (HAND) you can enter a temperature set-point, a humidity set-point, the fan speed (0% to 100%) and the switching-state of up to 8 operation lines (non-functional with standard unit). All settings remain valid in Manual Mode (HAND) until the next manual change, if the unit had been turned off or in case of toggling to Idle Mode or Program Mode (AUTO).

### 8.1 Entering the set point values

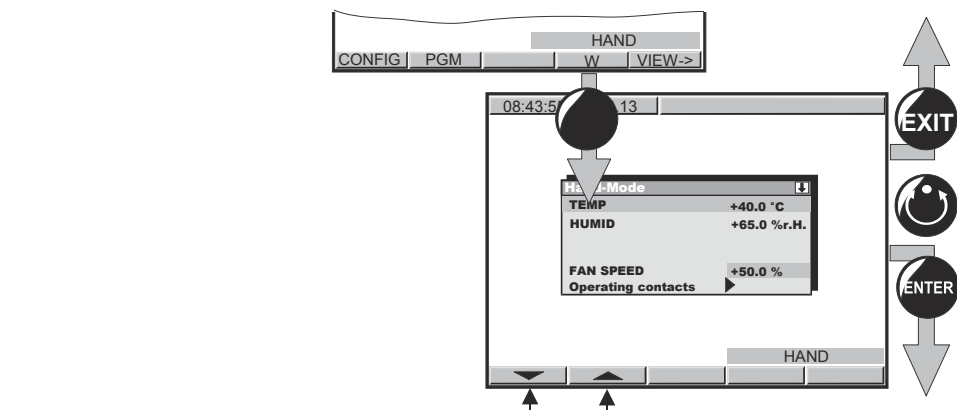
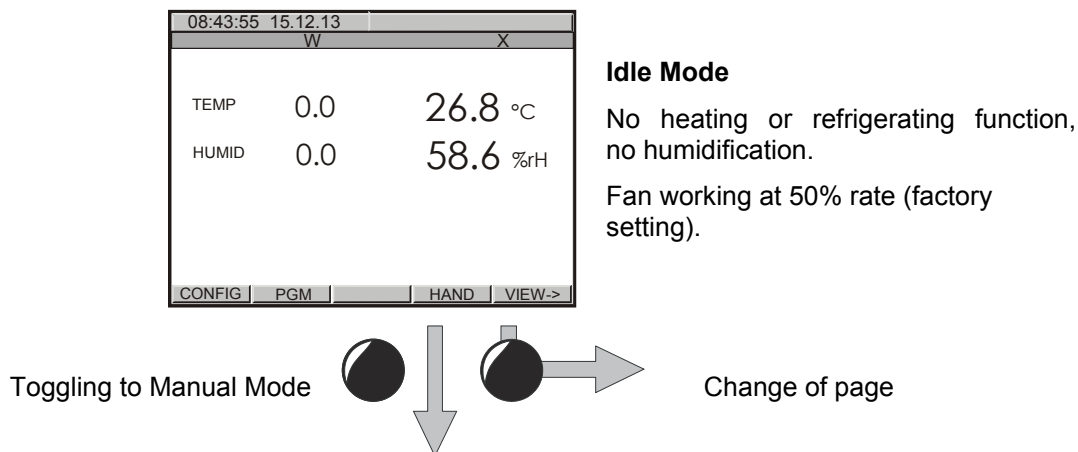

Toggling between temperature set-point, humidity set-point, and fan speed

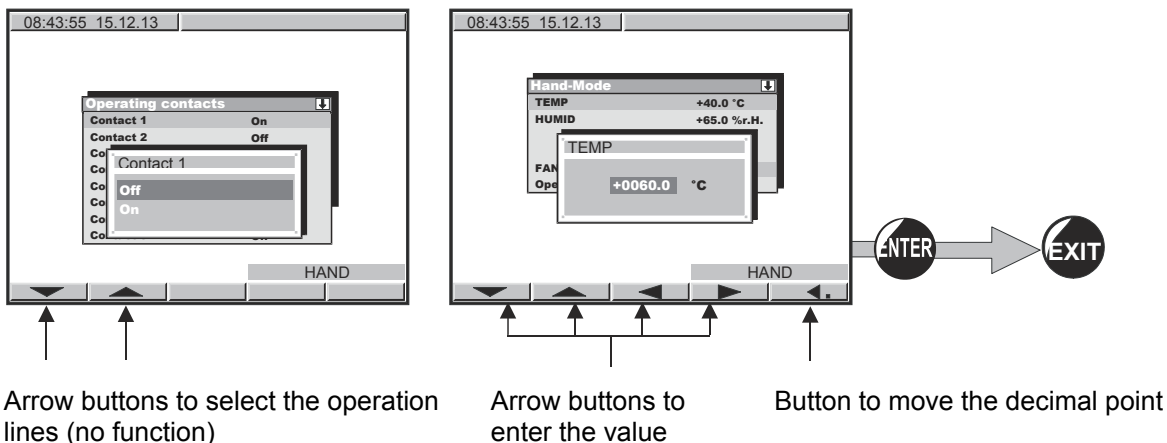

**Set-point ranges:**

<b>Temperature</b>	<p>Setting range: -5 °C / 23 °F up to 70 °C / 158 °F</p> <p>Control range: 0°C / 32 °F to + 70°C / 158 °F (without humidity), + 10 °C / 50 °F to +70 °C / 158 °F (climatic operation)</p> <p>(KBF P: Control ranges with illumination see technical data, chap. 19.4)</p>
<b>Humidity</b>	<p>Setting range: 0 % r.H. to 80 % r.H.</p> <p>Control range: 10 % r.H. to 80 % r.H.</p> <p>(KBF P: Control ranges with illumination see technical data, chap. 19.4)</p> <p>For possible combinations of temperature and humidity values without condensation, see temperature / humidity diagram in chap. 12.</p>
<b>Fan speed</b>	<p>0 % (approx. 25 % of full speed) up to 100 % (full speed). The percent value of fan speed on the controller does not correlate directly to the change in rpm of the fan motor.</p> <p>Reduce the fan speed only if required, because the spatial distribution of temperature and humidity will also be reduced.</p> <p><b>Technical data refers to 100% fan speed.</b></p>



Due to safety reasons, reducing the fan speed to standstill is NOT possible. Thus, even if you set the fan speed value to 0%, the fan will continue running at a reduced speed (approx. 25 % of full speed).

For the control range of temperature and relative humidity, see temperature / humidity diagram chap. 12).



With set-point type “**Limit**”, adapt the safety controller (chap. 10.2) or the temperature safety device class 3.3 (option, chap. 10.3) always when you changed the temperature set-point. Set the safety controller set-point or the set-point of temperature safety device class 3.3 (option) by approx. 2 °C to 5 °C above the controller temperature set-point.

Recommended setting: Set-point type “**Offset**” with safety controller set-point 2 °C.

In Manual Mode, no program can be started. Set-points can be entered for temperature and for humidity. The actual values equilibrate to these set-points.

When pushing the EXIT button in Manual Mode, the controller changes to Idle Mode. The set-points entered in Manual Mode remain saved.



When incidentally pressing the “EXIT” button during Manual Mode operation, the controller will change to Idle Mode and thus will not adjust any longer to the program set-points.

We recommend keyboard locking (chap. 15.7, available via BINDER INDIVIDUAL customized solutions) during operation.



For a negative set-point entry, enter the numerical value first and then the minus sign (-).



When operating without humidity (humidity switch (4) OFF), set the humidity set-point in Manual Mode to 0 % r.H. in order to avoid alarms (in case of the humidity deviating by more than +/- 5% from the set-point).



## 8.2 Entering the set point values for KBF P when operating without illumination

The KBF P has been adjusted for operation with illumination. Since the illumination creates a heat input in the chamber, this must be considered when entering a setpoint without illumination. For this reason, adapting the setting of the temperature set-point according to the following table is required.

Target temperature value	Set-point entry without illumination	
	KBF P 240	KBF P 720
10 °C	10 °C	11 °C
20 °C	21 °C	21 °C
30 °C	31 °C	32 °C
40 °C	41 °C	42 °C
50 °C	51 °C	53 °C
60 °C	62 °C	63 °C
70 °C	72 °C	74 C

Adapting the setting of the humidity set-point according to the following table is also required.

Target humidity value	Set-point entry without illumination	
	KBF P 240	KBF P 720
10 % r.H.	10 % r.H.	9 % r.H.
20 % r.H.	19 % r.H.	17 % r.H.
30 % r.H.	26 % r.H.	25 % r.H.
40 % r.H.	36 % r.H.	34 % r.H.
50 % r.H.	45 % r.H.	43 % r.H.
60 % r.H.	55 % r.H.	52 % r.H.
70 % r.H.	65 % r.H.	61 % r.H.
80 % r.H.	75 % r.H.	71 % r.H.

## 8.3 Performance after power failure in Manual Mode

In Manual Mode (HAND), all functions return exactly to the same status the chamber had before power failure. The set-points are immediately resumed. No error message indicating that a power failure has taken place is displayed. However, the power failure will appear in the event list.

## 9. Program operation

The MB1 2-channel program controller permits programming temperature and humidity cycles. It offers 25 program memory positions with 100 program sections each. The total cumulative number of program sections is limited to 500. It is not possible to link several programs.

For each program section a temperature set-point, a humidity set-point, the fan speed (0% to 100%), and the switching-state of up to 8 operation lines (non-functional with standard unit) can be entered.

Programming is possible directly by the keypad of the controller or graphically by the software APT-COM™ 3 DataControlSystem (option, chap. 15.1) specially developed by BINDER.

## 9.1 Menu-based program entry

Displays showing the initial normal display in Idle Mode

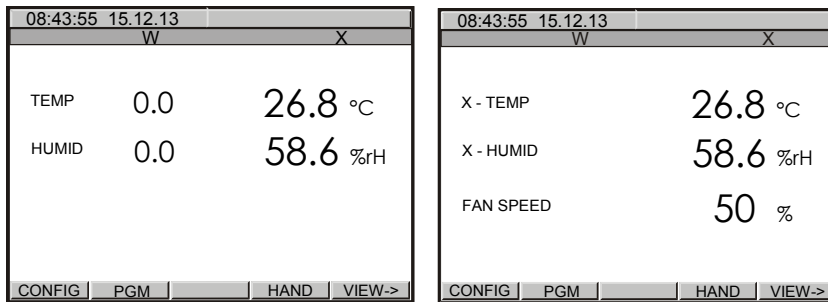

Hit button PGM. The window **program selection** appears.



Select a program via the arrow keys and confirm by pressing "ENTER".

The following display serves to select a **subroutine**:

TP-Program 1	Entry of temperature values and fan speed setting
TP-Program 2	Entry of humidity values
TP-Program 3	no function

## 9.2 Entry of temperature values and fan speed

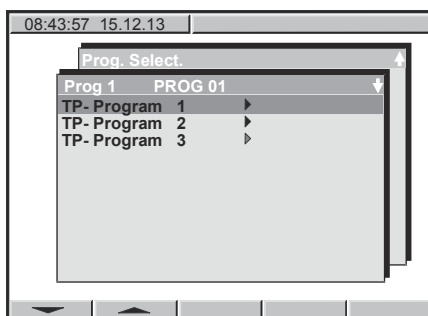

Select the first subroutine "**TP-Program 1**" and confirm by pressing "ENTER".

A **program table** will appear, which is initially empty until you enter the temperature values. You can now enter the temperature program.

Temperature at the beginning of the program section

Program No.

Subprogram TP-Program No. 1

Total number of program sections

Fan speed in %

Factory setting:  
50% in Idle Mode  
100% in Manual Mode and Program Mode

Duration of program section

08:43:55		15.12.13	
Pgm-Editor		Pgm-Name	
3		PROG 03	
Pgm-Nr		ZP-Prog-Nr	
1		Abschn. 0	
No	W-1	FAN	Time
			Sk
			No
			Cy
			Tmin
			Tmax
			Pa

Parameter set (preselected)

Tolerance band limits temperature (maximum and minimum temperature)

Number of duplicates in case of repeat cycles

Operation lines (no function)

Number of start section in case of repeat cycles

You can enter **Program sections** into this program table.

Hit the "PGM" button. An inquiry display appears allowing you to enter or delete individual program sections.

ZP-Abschnitt	Abs. Nr. 5
new	▶
insert	▶
delete	▶

In this view, new program lines can be entered or deleted:

new	New lines are added below in the table
insert	New lines are added above a previously selected line
delete	Individual lines that have been selected previously are deleted

Create as many lines, i.e. program sections, as desired. As a next step, values can be entered into these lines. It is possible to add supplementary lines later or to delete individual lines at any time.

08:43:55		15.12.13	
Pgm-Editor		Pgm-Name	
3		PROG 03	
Pgm-Nr		ZP-Prog-Nr	
1		Abschn. 2	
No	W-1	FAN	Time
			Sk
			No
			Cy
			Tmin
			Tmax
			Pa
1	0.0	*****	00:00:00
			0000000000
			1 0
			-1999 +9999
			1
2	0.0	*****	00:00:00
			0000000000
			1 0
			-1999 +9999
			1
PGM			

To enter values, select the corresponding line via the arrow keys.

Hit the "ENTER" button. The **program editor** appears.

Enter the individual values of the selected program section.

Program editor	Abs.Nr. 6
Setpoint 1	+100.0
FAN	****
Operating contacts	▶
Time	00:45:00
Repeat Section	5
Repeat Number	10
Tol.-band min.	-1999.0
Tol.-band max.	+9999.0
Parameter set	1

Setpoint 1	Temperature value at the start of the program section
FAN	Fan speed in %
Operating contacts	Operation lines (no function)
Time	Duration of the program section
Repeat Section	No. of start section in case of repeat cycles
Repeat Number	No. of duplicates in case of repeat cycles
Tol.-band min.	Temperature limits (maximum / minimum temperature) <b>(In case of exceeding: temporary program stop)</b>
Tol.-band max.	
Parameter set	Pre-selected value (Do NOT change!)

Select the parameters via the arrow keys and confirm by pressing "ENTER".

Then enter the values via the arrow keys, and confirm by pressing "ENTER".

	For a negative set-point entry, enter the numerical value first, and then the minus sign (-).
---	---

	<p>With set-point type "<b>Limit</b>", the user shall adapt the safety controller (chap. 10.2) or the temperature safety device class 3.3 (option, chap. 10.3) to the highest temperature set-point value of the program actually used. Check the safety device for each temperature program and change it if necessary. Set the safety controller set-point or the set-point of the temperature safety device class 3.3 (option) by approx. 2 °C to 5 °C above the controller temperature set-point.</p> <p>Recommended setting: Set-point type "<b>Offset</b>" with set-point 2 °C.</p>
---	---

	<p><b>Entering the set point values for KBF P when operating without illumination:</b></p> <p>Adapt the setting of the temperature set-point according to the table in chap. 8.2.</p>
---	---

#### Performance after completing the program:

The controller changes to Idle Mode. Heating, refrigeration, and humidification are inactive; the chamber approximates ambient temperature. The fan turns at 50% rate (factory setting).

**Note for KBF P:** When the illumination is operating, the inner chamber temperature may rise considerably after the program ends. When operating with illumination, an additional program section at the end of the program is therefore required. This program section gives the desired final temperature and is repeated infinitely (enter the number of cycles "Cy" as "-1"), i.e., until cancelling the program manually (press the EXIT or AUTOMATIC button).

	<b>CAUTION</b>
	<p><b>Too high inner chamber temperature.</b></p> <p><b>Damage of the lamps and the charging material.</b></p> <ul style="list-style-type: none"> <li>➤ When operating with illumination, program an additional program section.</li> <li>➤ Set the safety controller to set-point type "Offset" with set-point 5 °C</li> </ul>

### 9.3 Entry of humidity values

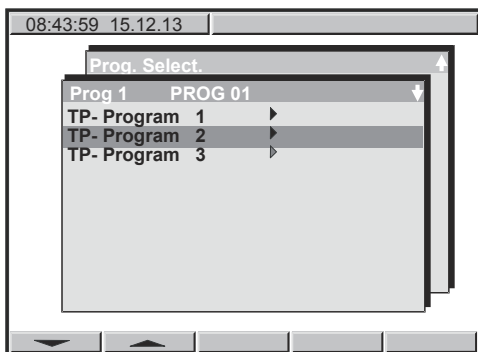

Select the second subroutine "**TP-Program 2**" and confirm by pressing "ENTER". A program table will appear, which is initially empty until you enter the humidity values. You can now enter the humidity program.

Humidity at the beginning of the program section	Program No.	Subprogram TP-Program No. 2	Total number of program sections																																				
Fan speed in % (no function)	<table border="1" style="width: 100%; border-collapse: collapse;"> <tr> <td colspan="2">08:43:55 15.12.13</td> <td colspan="2">PROG 03</td> </tr> <tr> <td>Pgm-Editor</td> <td>Rgm-Name</td> <td>ZP-Prog-Nr</td> <td>Z</td> </tr> <tr> <td>No</td> <td>W-1</td> <td>FAN</td> <td>Time</td> </tr> <tr> <td></td> <td></td> <td></td> <td>Sk</td> </tr> <tr> <td></td> <td></td> <td></td> <td>No</td> </tr> <tr> <td></td> <td></td> <td></td> <td>Cy</td> </tr> <tr> <td></td> <td></td> <td></td> <td>Tmin</td> </tr> <tr> <td></td> <td></td> <td></td> <td>Tmax</td> </tr> <tr> <td></td> <td></td> <td></td> <td>Pa</td> </tr> </table>		08:43:55 15.12.13		PROG 03		Pgm-Editor	Rgm-Name	ZP-Prog-Nr	Z	No	W-1	FAN	Time				Sk				No				Cy				Tmin				Tmax				Pa	Parameter set (preselected)
08:43:55 15.12.13		PROG 03																																					
Pgm-Editor	Rgm-Name	ZP-Prog-Nr	Z																																				
No	W-1	FAN	Time																																				
			Sk																																				
			No																																				
			Cy																																				
			Tmin																																				
			Tmax																																				
			Pa																																				
Duration of program section	Number of start section in case of repeat cycles	Number of duplicates in case of repeat cycles	Tolerance band limits humidity (maximum and minimum humidity)																																				
	Operation lines (no function)																																						

Proceeding further is equivalent to the temperature value entry described in chap. 9.2.

#### Time course of the subroutines:

When starting the overall program, both subroutines (TP-Program 1 and TP-Program 2) will run synchronously. They should be of the same duration because each of the subroutines becomes inactive after run-off (i.e., no heating or refrigeration and 50% fan speed after ZP 1 is completed, no humidification after ZP 2 is completed). When the complete program is finished, the controller changes to Idle Mode. Temperature and humidity proceed towards ambient values.

	<p><b>Entering the set point values for KBF P when operating without illumination:</b></p> <p>Increase the setting of the humidity set-point according to the table in chap. 8.2.</p>
--	---

#### Performance after completing the program:

The controller changes to Idle Mode. Heating, refrigeration, and humidification are inactive; the chamber approximates ambient temperature. The fan turns at 50% rate (factory setting).

## 9.4 Selecting between “set-point ramp” and “set-point step”

Set-points always refer to the start of a program section, i.e., at the beginning of each program section the entered “set-point” is targeted. During program section operation, the temperature or humidity gradually passes to the set-point entered for the next section.

By appropriate planning of the program section timing, you can enter all kinds of temperature and humidity transitions:

- **Gradual temperature / humidity changes “set-point ramp”**

The set-point changes its value gradually while proceeding from one program section to the next one during the programmed section length. The actual temperature or humidity value (X) follows the continually moving set-point (W) at any time.

- **Program sections with constant temperature / humidity**

The initial values of two subsequent program sections are identical; so the temperature or humidity remains constant during the whole time of the first program section.

- **Sudden temperature / humidity changes “set-point step”**

Steps are temperature or humidity changes (ramps) that occur during a very short interval. A section with a different set-point follows two program sections with an identical set-point. If the duration of this transitional program section is very short (minimum entry 1 sec), the temperature or humidity change will proceed rapidly within the minimum amount of time.

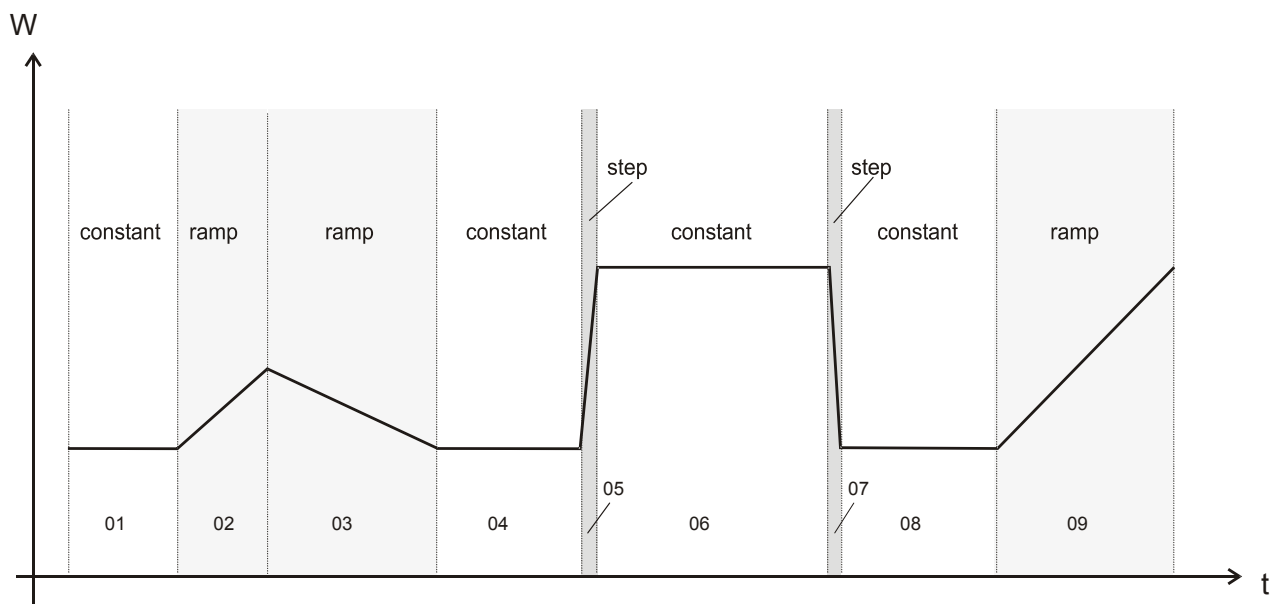

Figure 19: Possible temperature or humidity transitions

The following chapter offers examples of programming a “set-point ramp” and a “set-point step”.

## 9.5 Program entry as “set-point ramp” or as “set-point step”

In order to avoid incorrect programming, we recommend plotting both the temperature and humidity profiles (chart templates in chap. 9.11 and 9.12) and entering the values into a table (templates in chap 9.13 and 9.14).

The controller provides 8 operation lines (non-functional with standard unit) that can be activated or deactivated for each program section.

### Program entry as “set-point ramp” (example of a temperature program)

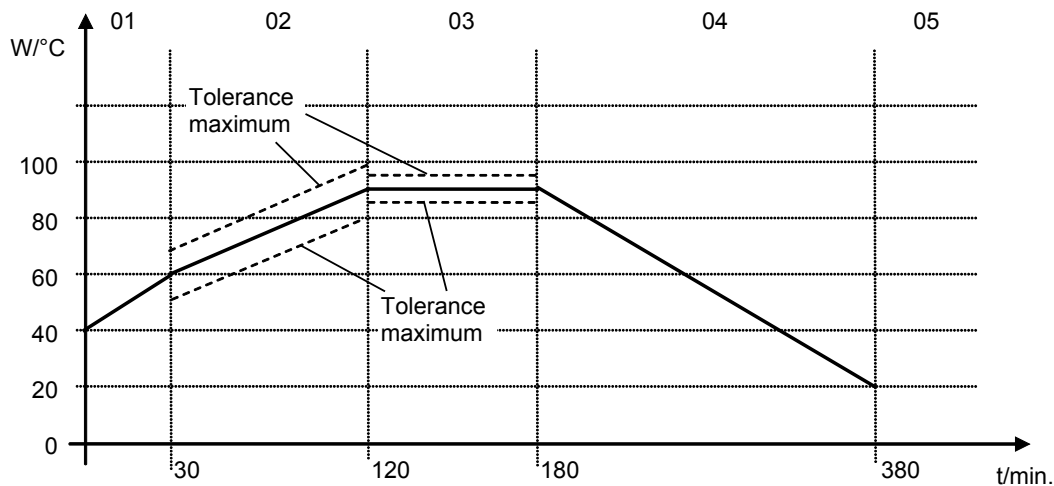

Program table corresponding to the diagram above:

Program section	Set-point temp.	Fan	Section time	Operation lines	Target section	No. of cycles	Min. tolerance	Max. tolerance
01	40	100 %	00:30:00	Off	1	0	-1999	+9999
02	60	100 %	01:30:00	Off	1	0	-5	+5
03	90	100 %	01:00:00	Off	1	0	-2	+2
04	90	100 %	03:20:00	Off	1	0	-1999	+9999
05	20	100 %	00:00:01	Off	1	0	-1999	+9999

Now enter the values of the above program table into one of the 25 program places of the MB1 controller:

08:43:55		15.12.13																	
Pgm-Editor		Pgm-Name		PROG 03															
Pgm-Nr		3		ZP-Prog-Nr		1		Abschn.								5			
No	W-1	FAN	Time	Sk	No	Cy	Tmin	Tmax	Pa										
1	40.0	****.	00:30:00	00000000	1	0	-1999	+9999	1										
2	60.0	****.	01:30:00	00000000	1	0	- 5	+ 5	1										
3	90.0	****.	01:00:00	00000000	1	0	- 2	+ 2	1										
4	90.0	****.	03:20:00	00000000	1	0	-1999	+9999	1										
5	20.0	****.	00:00:01	00000000	1	0	-1999	+9999	1										
										PGM									

**Program entry as “set-point step” (example of a temperature program)**

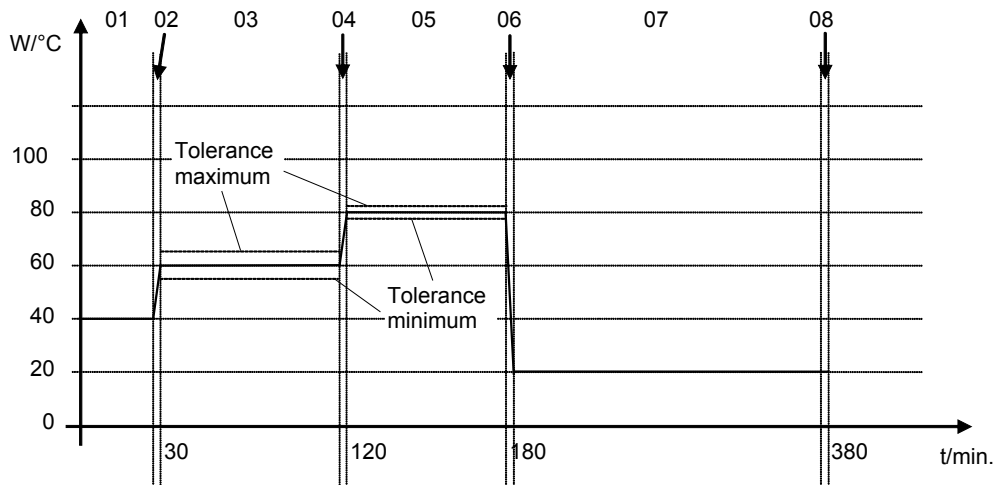

Program table corresponding to the diagram above:

Program section	Set-point temp.	Fan	Section time	Operation lines	Target section	No. of cycles	Min. tolerance	Max. tolerance
01	40	100 %	00:30:00	Off	1	0	-1999	+9999
02	40	100 %	00:00:01	Off	1	0	-1999	+9999
03	60	100 %	01:30:00	Off	1	0	-5	+5
04	60	100 %	00:00:01	Off	1	0	-1999	+9999
05	80	100 %	01:00:00	Off	1	0	-2	+2
06	80	100 %	00:00:01	Off	1	0	-1999	+9999
07	20	100 %	03:20:00	Off	1	0	-1999	+9999
08	20	100 %	00:00:01	Off	1	0	-1999	+9999

Now enter the values of the above program table into one of the 25 program places of the MB1 controller:

08:43:55		15.12.13																			
Pgm-Editor		Pgm-Name		PROG 03																	
Pgm-Nr		3		ZP-Prog-Nr		1		Abschn.		5											
No	W-1	FAN	Time	Sk	No	Cy	Tmin	Tmax	Pa												
1	40.0	****.	00:30:00	00000000	1	0	-1999	+9999	1												
2	40.0	****.	00:00:01	00000000	1	0	-1999	+9999	1												
3	60.0	****.	01:30:00	00000000	1	0	- 5	+ 5	1												
4	60.0	****.	00:00:01	00000000	1	0	-1999	+9999	1												
5	80.0	****.	01:00:00	00000000	1	0	- 2	+ 2	1												
6	80.0	****.	00:00:01	00000000	1	0	-1999	+9999	1												
7	20.0	****.	03:20:00	00000000	1	0	-1999	+9999	1												
8	20.0	****.	00:00:01	00000000	1	0	-1999	+9999	1												
										PGM											



For rapid transition phases, do NOT program any tolerance limits in order to permit maximum heating, refrigerating, and humidification speed.



## 9.6 Information on programming different temperature or humidity transitions

- For the end value of the desired cycle, add an additional section (in the examples section 05 for “set-point ramp” and section 08 for “set-point step”) with a section time of at least one second. Otherwise, the program will stop one section too early because the program line is incomplete.
- When operating without humidity (humidity switch (4) OFF), enter a humidity sub-program with the humidity set-point set to “0” to avoid alarms (in case the humidity deviates by more than +/- 5% from the set-point).
- **Program interruption (rest function):** Hit key "HAND" in order to interrupt the program. During this program interruption time the controller equilibrates to the set-points of the section actually reached.
- The display reads “AUTO HAND” on the bottom right instead of “AUTO” (program operation). This state lasts until you hit the “EXIT” key, then the program continues. If you want to cancel the interrupted program, keep the “AUTOMATIC” button pressed down for at least 5 seconds.
- **Tolerance band function:** If the tolerance minimum is set to e.g. -5 and the tolerance maximum to e.g. +5, the program is interrupted when the actual value deviates by 5 °C resp. 5 % r.H. or more from the “set-point” value. During this program interruption time the controller equilibrates to the set-points of the section actually reached. The display reads “AUTO HAND” on the bottom right instead of “AUTO” (program operation). You can enter different values for tolerance maximum and minimum for each section. When the temperature or humidity are situated within the entered tolerance limits, the program is automatically continued, and the indication “AUTO HAND” disappears. If you want to cancel the interrupted program, keep the “AUTOMATIC” button pressed down for at least 5 seconds.



Programming of tolerances can extend program duration.

The number -1999 for the tolerance minimum means “-∞” and the number 9999 for the tolerance maximum means “+ ∞”. Entry of these numbers will never lead to program interruption.

When leaving the tolerance bandwidth in one of the subroutines, the course of time of the whole program, i.e., of both subroutines, is halted.

During the rapid transition phase, do NOT program any tolerance limits in order to permit the maximum heating, refrigerating, or humidification speed.

- The initial setting \*\*\*\*.\* of the fan speed corresponds to the maximal speed of 100 %.



Do reduce the fan speed rate “ONLY” if it’s absolutely necessary for the essay. Usually, the spatial exactitude of temperature and of humidity decreases with lesser ventilation. Technical data refers to a 100 % fan speed rate.

- Programming is stored even in case of power failure or after turning off the unit.
- The controller memory can store a maximum of 25 programs. Each program cannot exceed 100 sections. It is not possible to link programs. The total number of program sections of all programs is limited to a maximum of 500.
- Running program (display AUTO): If you incidentally press the “EXIT” or “AUTOMATIC” button, the controller will change to Idle Mode and thus will not adjust any longer to the program set-points
- Program interruption with rest function (display AUTO HAND): If you press the “EXIT” key, the program continues. Button “ENTER” is non-functional. To cancel the program, keep the “AUTOMATIC” button pressed down for at least 5 seconds.
- Program interruption with tolerance band function (display AUTO HAND): Buttons EXIT and ENTER are non-functional. To cancel the program, keep the AUTOMATIC button pressed down for 5 seconds.

### General note:

The MB1 controller displays more menu entries than those described in this manual. These are password protected because they are relevant for service purposes only and the user must not modify them. Only service authorized by BINDER can access these entries.

## 9.7 Repetition of a section or several sections within a program

Here we use the example of a set-point ramp temperature program of chap. 9.5. The shaded sections 02 and 03 shall be repeated e.g. 30 times.

Program section	Set-point temp.	Fan	Section time	Operation lines	Target section	No. of cycles	Min. tolerance	Max. tolerance
01	40	100 %	00:30:00	Off	1	0	-1999	+9999
02	60	100 %	01:30:00	Off	1	0	-5	+5
03	90	100 %	01:00:00	Off	1	0	-2	+2
04	90	100 %	03:20:00	Off	1	0	-1999	+9999
05	20	100 %	00:00:01	Off	1	0	-1999	+9999

The following table shows the program that results, whereby the differences to the table above are shaded.

Program section	Set-point temp.	Fan	Section time	Operation lines	Target section	No. of cycles	Min. tolerance	Max. tolerance
01	40	100 %	00:30:00	Off	1	0	-1999	+9999
02	60	100 %	01:30:00	Off	1	0	-5	+5
03	90	100 %	01:00:00	Off	2	30	-2	+2
04	90	100 %	03:20:00	Off	1	0	-1999	+9999
05	20	100 %	00:00:01	Off	1	0	-1999	+9999

Sections 02 and 03 will be executed in total 31 times; only then will the program continue.

Entry of the values into the display program table:

08:43:55 15.12.13									
Pgm-Editor									
Pgm-Name			PROG 03						
Pgm-Nr		3	ZP-Prog-Nr			1	Abschn.		5
No	W-1	FAN	Time	Sk	No	Cy	Tmin	Tmax	Pa
1	40.0	*****	00:30:00	00000000	1	0	-1999	+9999	1
2	60.0	*****	01:30:00	00000000	1	0	- 5	+ 5	1
3	90.0	*****	01:00:00	00000000	2	30	- 2	+ 2	1
4	90.0	*****	03:20:00	00000000	1	0	-1999	+9999	1
5	20.0	*****	00:00:01	00000000	1	0	-1999	+9999	1
<div style="display: flex; justify-content: space-around;"> <span>▼</span> <span>▲</span> <span>PGM</span> </div>									



To have sections repeated infinitely, enter the number of cycles “Cy” as -1.

## 9.8 Performance after power failure in Program Mode

The program is resumed at the point where the interruption occurred with the latest set-points reached during the program run. The power failure is noted in the event list. No error message is displayed indicating that a power failure had taken place.

## 9.9 Starting a previously entered program

The program has to be previously entered via a programming table (chap. 9.5, 9.7).

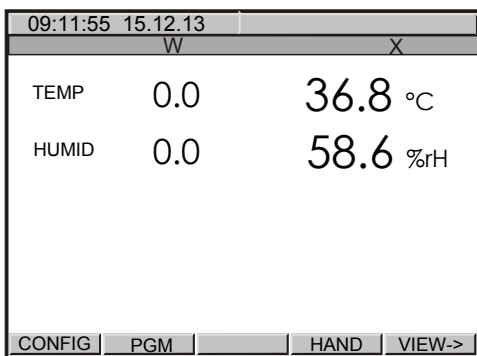

### Idle mode

No heating or refrigerating function, no humidification.

The fan turns at 50% rate (factory setting).

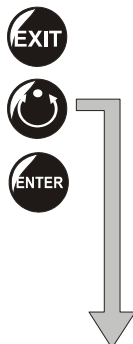

Select a program place  
Delayed program start  
Start with section ...  
Remaining time of the selected start section

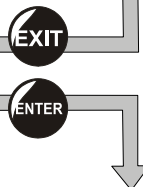
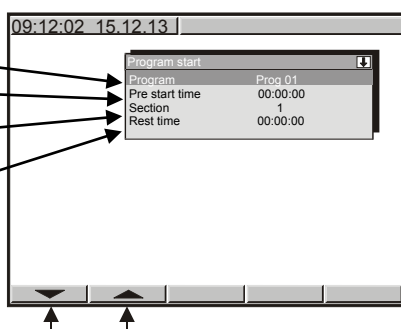

Arrow buttons to select the parameter to be set.

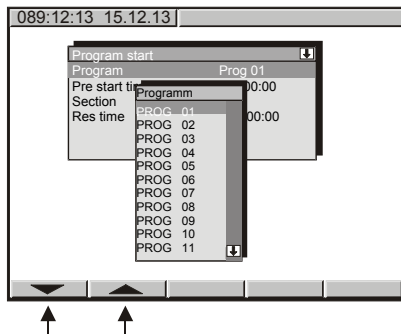

Press "AUTOMATIC" button to start the program

Arrow buttons to select the program

## 9.10 Deleting a program

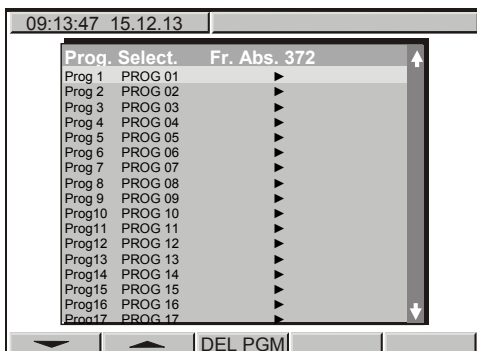

Select a program via the arrow keys

Hit button **DEL PGM** to delete the selected program.

To delete individual program sections (table lines) use the inquiry display for adding or deleting program sections (chap. 9.1).

### 9.11 Template for temperature profile

<b>Programmer:</b>		<b>Program No. (1 to 25):</b>	<b>Date:</b>
<b>Program title:</b>		<b>Operation lines are without function</b>	
<b>Project:</b>			



### 9.12 Template for humidity profile

Programmer:		Program No. (1 to 25):	Date:
Program title:		Operation lines are without function	
Project:			

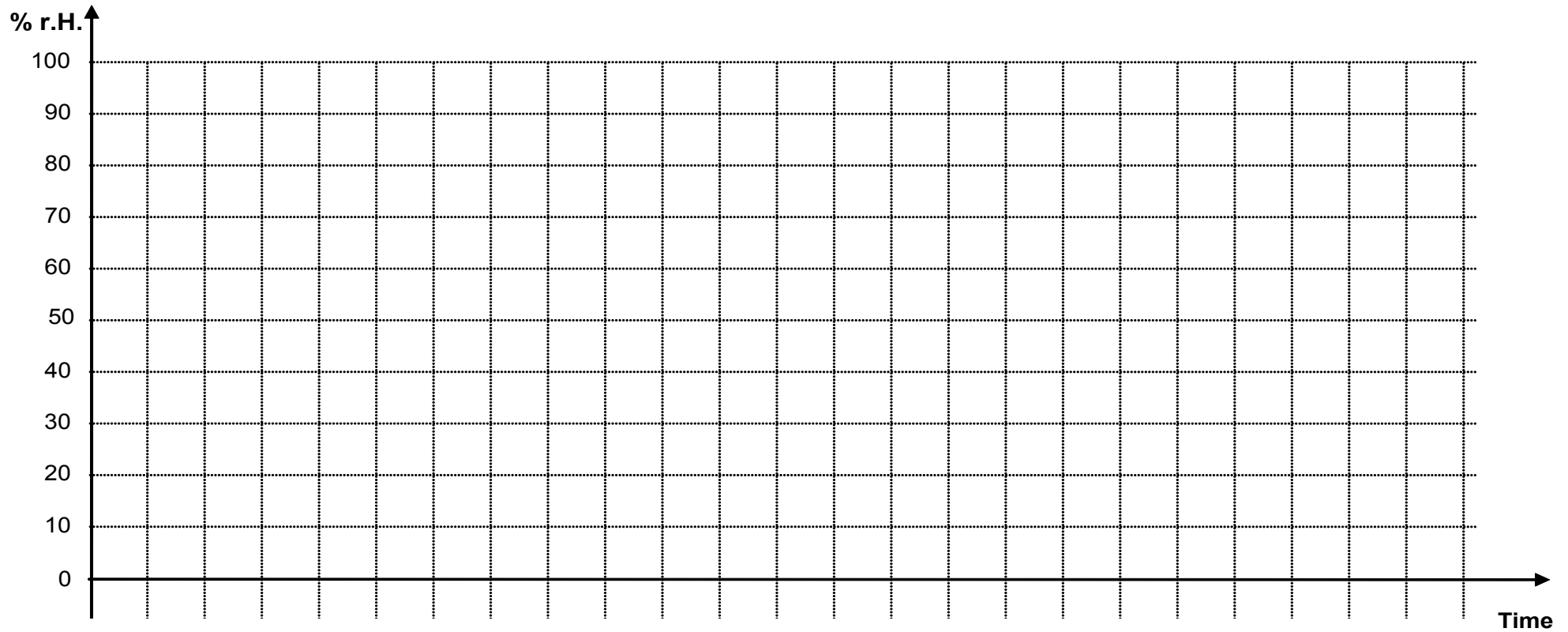

### 9.13 Program table template for temperature and fan speed rate

<b>Programmer:</b>		<b>Program No. (1 to 25):</b>	<b>Date:</b>
<b>Program title:</b>		<b>Operation lines are without function</b>	
<b>Project:</b>			

Section No.	Set-point Temperature	Fan speed [%]	Section time	Operation lines (no function)	Start section for repeat cycles	Number of repeat cycles	Tolerance minimum Temperature T <sub>min</sub>	Tolerance maximum Temperature T <sub>max</sub>	Parameter set
	W-1	FAN	Time	Sk	No	Cy			Pa
01									1
02									1
03									1
04									1
05									1
06									1
07									1
08									1
09									1
10									1
11									1
12									1
13									1
14									1
15									1
16									1
17									1
18									1
19									1
20									1

Default setting

### 9.14 Program table template for humidity

<b>Programmer:</b>		<b>Program No. (1 to 25)</b>	<b>Date:</b>
<b>Program title:</b>		<b>Operation lines are without function</b>	
<b>Project:</b>			

Section No.	Set-point Humidity W-1	Fan speed (no function) FAN	Section time Time	Operation lines (no function) Sk	Start section for repeat cycles No	Number of repeat cycles Cy	Toler. minimum Humidity Tmin	Toler. maximum Humidity Tmax	Parameter set Pa
01		****.		00000000					1
02		****.		00000000					1
03		****.		00000000					1
04		****.		00000000					1
05		****.		00000000					1
06		****.		00000000					1
07		****.		00000000					1
08		****.		00000000					1
09		****.		00000000					1
10		****.		00000000					1
11		****.		00000000					1
12		****.		00000000					1
13		****.		00000000					1
14		****.		00000000					1
15		****.		00000000					1
16		****.		00000000					1
17		****.		00000000					1
18		****.		00000000					1
19		****.		00000000					1
20		****.		00000000					1

no function

no function

Default setting

## 10. Temperature safety devices

### 10.1 Over temperature protective device (class 1)

The constant climate chamber KBF / KBF P is equipped with an internal temperature safety device, class 1 acc. to DIN 12880:2007. It serves to protect the unit and prevents dangerous conditions caused by major defects.

If a temperature of approx. 110 °C / 230 °F is reached, the over temperature protective device permanently turns off the unit. The user cannot restart the device again. The protective cut-off device is located internally. Only a service specialist can replace it. Therefore, please contact an authorized service provider or BINDER Service.

### 10.2 Safety controller (temperature safety device class 3.1)

The constant climate chamber is equipped with an over temperature safety device class 3.1 acc. to DIN 12880:2007. It is designated as the “safety controller”. This second, electrically independent temperature controller takes over at a selectable set point in case of a faulty condition. It serves to protect the charging material against extremely high temperatures.

	With option safety device class 3.3 (chap. 10.3) the safety controller is <b>not</b> used. In this case, do NOT change the pre-set value of 100 °C / 212 °F.
---	--

The message “TEMPERATURE LIMIT” on the controller display indicates safety controller activity. The safety controller controls the constant climate chamber to the entered safety controller set-point until the temperature inside the chamber returns below this temperature and until you then reset the alarm message by button RESET.

	<p>Regularly check the safety controller setting for set-point type “Limit” or “Offset”</p> <ul style="list-style-type: none"> <li>• in Manual Mode according to the entered set-point temperature value</li> <li>• in Program Mode according to the highest temperature value of the selected temperature program</li> </ul> <p>Set the safety controller set-point by approx. 2 °C to 5 °C above the desired temperature set-point.</p>
---	---

#### 10.2.1 Safety controller set-point types

<b>Limit</b>	<p>Absolute maximum permitted temperature value.</p> <p>Example:</p> <p>Temperature set-point 40 °C / 104 °F</p> <p>Limit value (safety controller set-point) set to 42 °C.</p>
<b>Offset</b>	<p>Maximum over temperature above the active temperature set point. The maximum temperature changes internally and automatically with every set-point change it.</p> <p>Example:</p> <p>Temperature set-point 40 °C / 104 °F</p> <p>Offset value (safety controller set-point) set to 2 °C.</p>

	Do NOT change the temperature unit from °C to °F.
---	---



## 10.2.2 Checking and setting safety controller set-point type and safety controller set-point

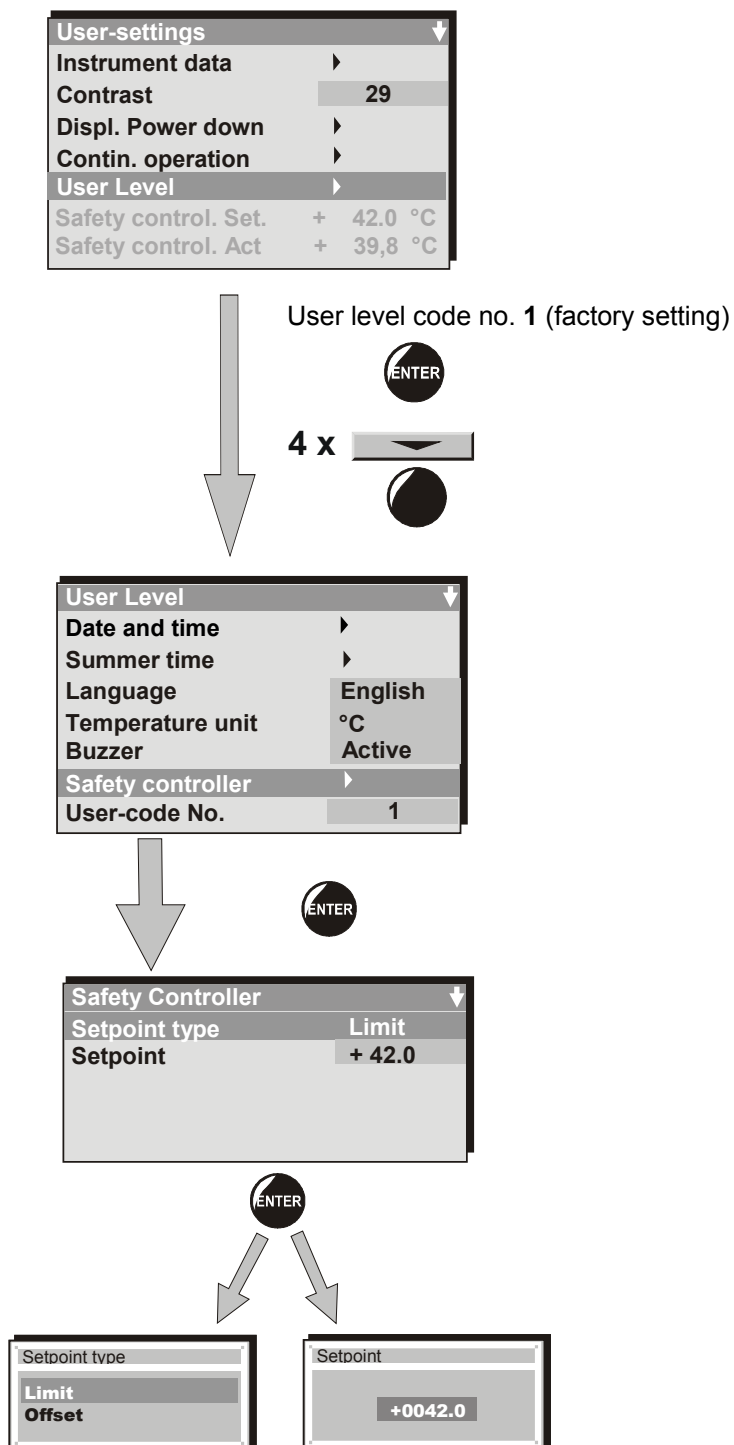

In the menu “User Level” select the submenu “Safety controller”.

- Select the safety controller set-point type “Limit” or “Offset” in the field “Setpoint type”
- Enter the value for “Limit” or “Offset” in the field “Setpoint”.

**For temperature disturbances see alarm indications, chap. 11.**

### 10.3 Temperature safety device class 3.3 (option)

With the option over/under temperature protective device (temperature safety device class 3.3 acc. to DIN 12880:2007) the unit is equipped with two additional safety devices (class 3.1 and class 3.2). The combination of the safety devices is regarded as a safety device class 3.3.

The temperature safety device, class 3.3, serves to protect the constant climate chamber, its environment and the contents from exceeding the maximum permissible temperature. Please observe the guideline BGI/GUV-I 850-0 on safe working in laboratories (formerly BGR/GUV-R 120 or ZH 1/119 laboratory guidelines issued by the employers' liability insurance association) (for Germany).

With **safety device class 3.1** a maximum value for the temperature is set that the unit will not exceed due to the regulatory function of the safety device class 3.1. This protection against excessively high temperatures can, for example, serve to protect the constant climate chamber, its environment and the material under treatment from excess temperatures.

With **safety device class 3.2** a minimum value for the temperature is set that the unit will not fall below due to the regulatory function of the safety device class 3.2. This protection against excessively low temperatures can, for example, serve to protect sensitive loads from under cooling.

Both safety devices are functionally and electrically independent of the temperature control system. If an error occurs, they perform a regulatory function.

Safety devices class 3.1 (14) and class 3.2 (15) are located in the left lateral control panel.

With option temperature safety device class 3.3, the safety controller (chap. 10.2) must be set to limit 100 °C / 212 °F.

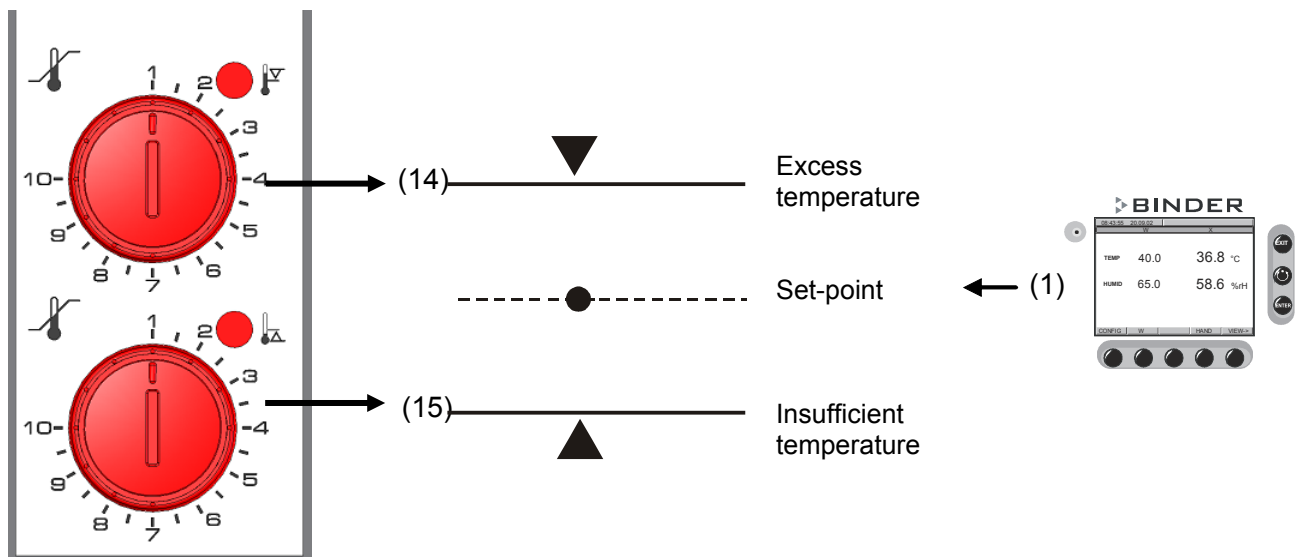
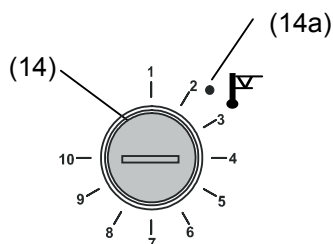

Figure 20: Temperature safety device class 3.3

### 10.3.1 Temperature safety device class 3.1



If you turn the control knob (14) to its end-stop (position 10), the safety device class 3.1 protects the appliance. If you set the temperature a little above the set-point, it protects the charging material.

If the safety device class 3.1 has taken over control, identifiable by the red alarm lamp (14a) lighting up, the message “TEMP ALARM” on the controller will be displayed and the buzzer will sound, then proceed as follows:

- Reset the buzzer by pressing the “RESET” key on the controller
- Disconnect the unit from the power supply
- Have an expert examine and rectify the cause of the fault.
- Start the unit again as described in chap. 5.

#### Setting:

To check the response temperature of the safety device class 3.1, turn on the chamber and set the desired set point at the temperature controller.

The sections of the scale from 1 to 10 correspond to the temperature range from 0 °C / 32 °F to 120 °C / 248 °F and serve as a setting aid.

- Turn the control knob (14) of the safety device using a coin to its end-stop (position 10) (unit protection).
- When the set point is reached, turn back the control knob (14) until its trip point (turn it counter-clockwise).
- The trip point is identifiable by the red alarm lamp (14a), the message “TEMP ALARM” on the controller display and the buzzer sounds. Reset the buzzer with the “RESET” key on the controller.
- The optimum setting for the safety device is obtained by turning the control knob clockwise by approximately two scale divisions, which shuts off the red alarm lamp (14a).

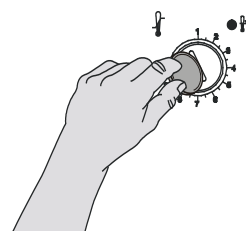

Figure 21: Setting safety device class 3.1



Check the setting regularly and adjust it following changes of the set-point or charge.

#### Function check:

Check the temperature safety device class 3.1 at appropriate intervals for its functionality. It is recommended that the authorized operating personnel should perform such a check, e.g., before starting a longer work procedure.

### 10.3.2 Temperature safety device class 3.2

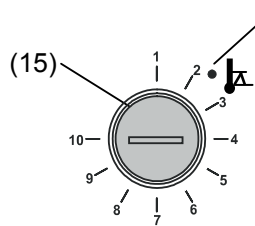

(15a) The safety device class 3.2 is equivalently set to a minimum temperature the unit will not fall below. This protection against prohibited low temperatures can, for example, serve to protect sensitive cultures from cooling down too much.

If the control knob (15) is turned to its minimum (position 1), the safety device class 3.2 has no effect. If it is set to a temperature somewhat lower than that selected by means of the controller, it functions as a protective device for the material under treatment.

If the temperature safety device class 3.2 has assumed regulation, identifiable by the red alarm lamp (15a) lighting up, the message "TEMP ALARM" on the controller display and the buzzer sounds, please proceed as follows:

- Reset the buzzer with the "RESET" key on the controller.
- Disconnect the unit from the power supply.
- Have an expert examine and rectify the cause of the fault.
- Start up the unit again as described in chap. 5.

#### Setting:

To check the response temperature of the safety device class 3.2, put the unit into operation and set the desired set point at the temperature controller.

The sections of the scale from 1 to 10 correspond to the temperature range from  $-40\text{ }^{\circ}\text{C}$  /  $-40\text{ }^{\circ}\text{F}$  to  $+160\text{ }^{\circ}\text{C}$  /  $320\text{ }^{\circ}\text{F}$  and serves as a setting aid.

- Turn the control knob (15) of the safety device by means of a coin to position 1 (thermostat without effect).
- When the set point is reached, reset the safety device to its trip point (turn it clockwise).
- The trip point is identifiable by the red alarm lamp (15a), the message "TEMP ALARM" on the controller display and the buzzer sounds. Reset the buzzer with the "RESET" key on the controller.
- The optimum setting for the safety device is obtained by turning the control knob counter-clockwise by approximately two scale divisions, which shuts off the red alarm lamp (15a).

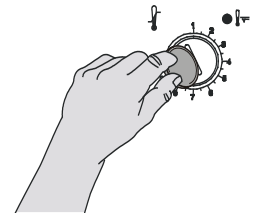

Figure 22: Setting safety device class 3.2



Check the setting regularly and adjust it following changes of the set-point or charge.

#### Function check:

Check the temperature safety device class 3.2 at appropriate intervals for its functionality. It is recommended that the authorized operating personnel should perform such a check, e.g., before starting a longer work procedure.

## 11. Notification and alarm functions



### 11.1 Notification and alarm system overview (auto diagnosis system)

The unit provides notification and alarm functions, which indicate messages in up to three steps:

1. Visual indication of notifying or error messages are blue notes on the display of the MB1 controller.
2. Visual indication of alarm messages are red notes with an alarm bell symbol. After a delay time, some notes change their color from blue to red.

In addition, there is an audible alert, if you did not deactivate the buzzer in the "User level" menu (chap. 6.4).

3. Zero-voltage relay outputs (option, chap. 15.5) allow transmitting the alarm e.g., to a central monitoring system.

Notifying sequence	1	2	3
<b>Event</b>	 <b>Note</b> (blue field)	 <b>Alarm</b> (red field)	<b>Zero-voltage relay alarm outputs (option)</b>
Error of the humidity system. Press RESET key for further information.	<b>HUMID SYSTEM</b> immediately	<b>HUMID SYSTEM</b> after 1 min.	
Notification or error of the humidity system. <i>For detailed information see chap. 11.2.</i>	<b>HUMID SYSTEM</b> (notification flashes)		
Temperature deviation of more than +/- 2 °C of the entered set-point	<b>TEMP RANGE</b> immediately	<b>TEMP RANGE</b> after 16 min.	after 16 min.
Humidity deviation of more than +/- 5 % r.H. of the entered set-point	<b>HUMID RANGE</b> immediately	<b>HUMID RANGE</b> after 16 min.	after 16 min.
Exceeded temperature limit of the safety controller		<b>TEMPERATURE LIMIT</b> immediately	
Humidity system turned off with switch (4)	<b>HUMID OFF</b> immediately		
Door open	<b>DOOR OPEN</b> immediately	<b>DOOR OPEN</b> after 5 min.	
Power failure			immediately
With option temperature safety device class 3.3 (chap. 10.3):			
Exceeding the maximum or minimum temperature		<b>TEMP ALARM</b> immediately	
With option locking of the keyboard (BINDER Individual, chap. 15.7):			
Locked keyboard	<b>KEY LOCK</b> immediately		

The indicated intervals refer to the time after occurrence of the error or notified condition.

## 11.2 Messages concerning the humidity system

- Notification of the humidity system

The flashing blue notification "HUMID SYSTEM" appears on the controller. This message flashes with a defined number of flashes from which the cause of the fault can be derived: number of flashes (each one 1 sec on / 1 sec off) followed by a 5 second pause.

- Error of the humidity system

First the blue notification "HUMID SYSTEM" appears on the controller. After 1 minute it changes to the alarm message "HUMID SYSTEM", and the buzzer is activated. After one minute, the alarm message and buzzer can be reset with the RESET key.

Following this reset, the flashing blue notification "HUMID SYSTEM" appears on the controller. This message flashes with a defined number of flashes from which the cause of the fault can be derived: number of flashes (each one 1 sec on / 1 sec off) followed by a 5 second pause.

Number of flashes	Notification and measures
1	Purging is required soon. Turn off and on again the humidity switch to start purging. After a successful purging the notification resets automatically.
2	Maintenance of the humidity system is required. Contact BINDER service.
Number of flashes	Cause of the error and measures
3, 4, 13	<i>In case of freshwater supply via water pipe:</i> The water tap is closed, or the unit is defective.  <i>In case of freshwater supply via freshwater can (option, chap. 15.9):</i> Water can is empty. Humidification is turned off. In case of refrigerating operation, the interior is strongly dehumidified. When the water supply is functional again, the humidity system restarts, or the unit is defective.
8, 9	Check the length and location of the wastewater tube. If appropriate contact BINDER service.
Other	The unit is defective. Contact BINDER service.

If the blue notification "HUMID SYSTEM" would be overlaid by the notification or alarm message "HUMID RANGE", you can set the humidity set-point to the actual value and then reset the "HUMID RANGE" message with the RESET key.

Turning off and on again the humidity switch (4) or turning off and on again the chamber with the main power switch (3) will reset the flashing notification "HUMID SYSTEM".

### 11.3 Resetting the notification or alarm messages

Resetting the "HUMID SYSTEM" notification or alarm message is described in chap. 11.2.

The "RESET" button, which serves to acknowledge and reset the indication, will become visible automatically whenever a notification or an alarm message appears.

1. Depending on the type of error, remove the cause of the disturbance or wait until the unit compensates for the reason of the error.
2. Press the "RESET" button to reset the notification or alarm message.

	<b>CAUTION</b>
	<p>In case the "RESET" button does not cancel the notification or alarm indication, the reason for the disturbance was not removed correctly.</p> <p>➤ Contact BINDER Service.</p>

	<p>The "RESET" button allows resetting the notification or alarm messages regarding temperature and humidity only within a tolerance sector of +/- 2 °C resp. +/- 5 % r.H.</p> <p>➤ With values outside this range, contact BINDER service.</p>
---	---

	<p>Humidity deviation by more than +/- 5 % r.H. from the set-point triggers the alarm message "HUMID RANGE".</p> <p>In order to avoid such limit alarms when operating without humidity (humidity switch (4) OFF):</p> <ul style="list-style-type: none"> <li>• in Manual Mode set the humidity set-point to 0 % r.H.</li> <li>• in Program Mode enter a humidity sub-program with the humidity set-points set to 0 % r.H.</li> </ul>
---	---

## 12. Humidity system

The humidity system is turned on with the humidity switch (4) located in the right lateral control panel.

The constant climate chamber KBF / KBF P is equipped with a capacitive humidity sensor. This results in a control accuracy of up to  $\pm 3\%$  r.H. of the set point. The temperature-humidity diagrams (Figure 21) show the possible working ranges for humidity.

The preset temperature and humidity values should be situated within the optimum range (hatched range in Figure 21). Only within this area will the unit not be exposed to excessive moisture due to condensation.

In the short-term set points outside the optimum range can also be targeted. The control accuracies of  $\pm 3\%$  r.H., however, cannot be guaranteed in this case.

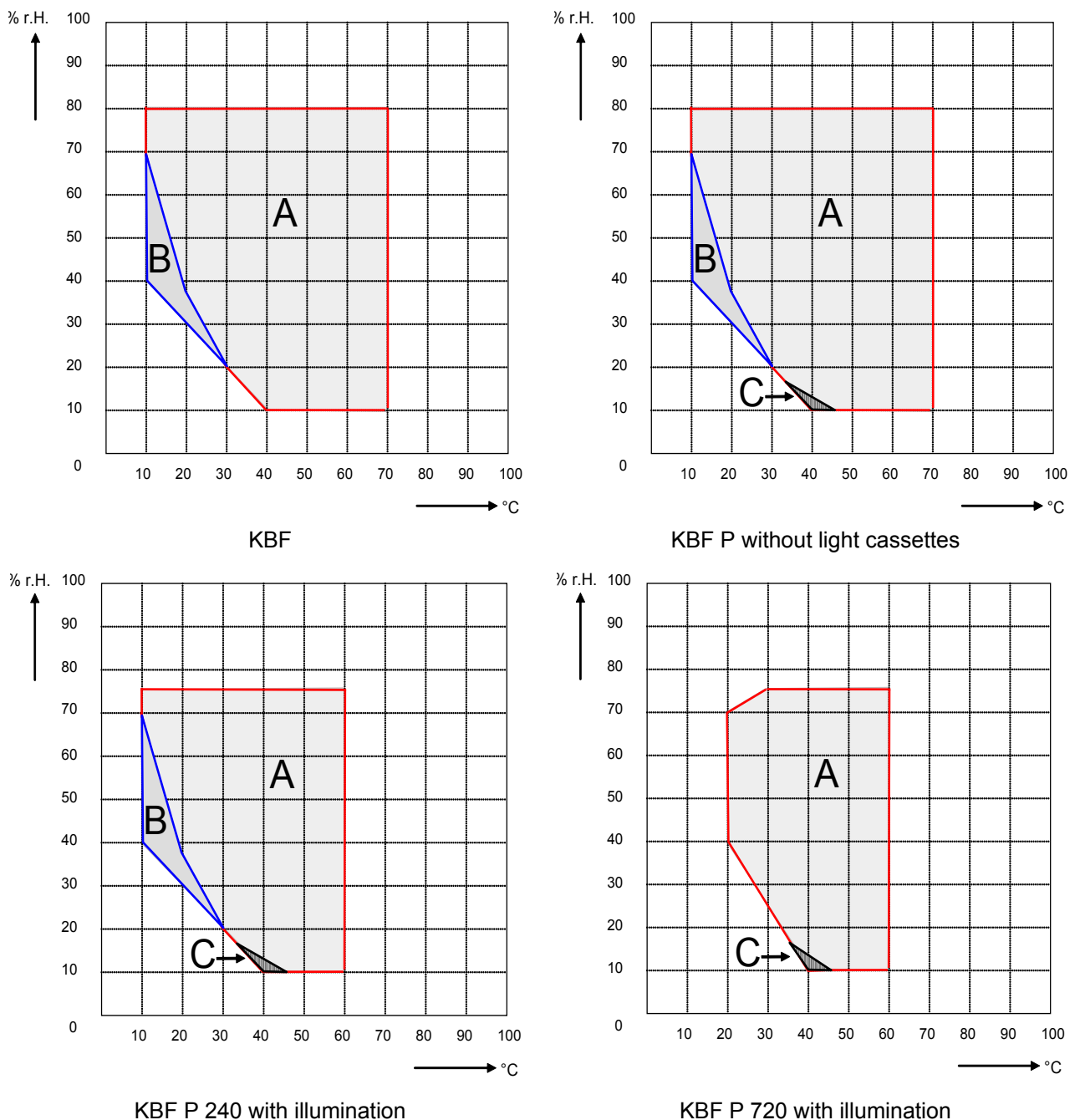

Figure 23: Temperature-Humidity diagrams



Range A: Control range of temperature and relative humidity

Range B: Discontinuous range (no continuous operation)

Range C: In this range, deviations of the technical data are possible



Heat emission of electrical devices connected inside the chamber may modify the temperature and humidity range.



Entry of the humidity set-point 0 % in defined program sections permits completely turning off humidity in Program Mode and thus attaining faster temperature changes.

**The constant climate chamber KBF / KBF P is equipped with a door heating system to prevent condensation in the door area.**

If the set points for temperature or humidity are outside the optimum range, condensation can arise in the door area.

	<b>CAUTION</b>
	<p><b>Condensation by excess humidity.</b></p> <p><b>Danger of corrosion on the housing after operating at humidity values &gt; 70 % r.H. for a long period.</b></p> <p>➤ Dry the appliance completely before shut-down:</p> <ul style="list-style-type: none"> <li>• Set the humidity to 0 % r.H. and turn on humidity switch (4).</li> <li>• Set the temperature set point to 60 °C / 140 °F for approx. 2 hours (Manual mode).</li> <li>• Only then, shut down the unit at the main power switch (3) and close the tap of the water supply.</li> </ul>



Having turned off the unit by the main power switch (3), always close the water supply tap.

If you operate the unit at high humidity and then immediately turn off the unit, the internal wastewater collector may overflow due to the condensate. This may lead to the emergence of water at the unit.

	<b>CAUTION</b>
	<p><b>Overflow of the internal wastewater tank due to condensate.</b></p> <p><b>Emergence of water at the unit.</b></p> <p>⊘ Following high humidity operation, do NOT directly turn off the unit.</p> <p>➤ Pump off the condensate before shut-down:</p> <ul style="list-style-type: none"> <li>• Set the humidity to 0 % r.H. and turn on the “humidity” switch (4). Operate the unit for at least 2 hours.</li> <li>• Only then, shut down the unit at the main power switch (3) and close the water supply tap.</li> </ul>

## 12.1 Function of the humidifying and dehumidifying system

### Humidifying system

The humidifying system is located in the humidity generation module. In a cylindrical container with a volume of about 2 liters an electrical resistance heating evaporates water. The water content is kept exactly at the boiling point, and thus steam can be immediately generated in sufficient quantity for rapid humidity increases or for compensation of humidity losses, e.g. by door openings. Condensation forming on the outer walls of the useable volume is led through a water drain in the outer chamber into the wastewater can which is pumped off automatically to the wastewater pipe when required.

### Freshwater

You can supply the unit with freshwater via a water pipe or by manually filling a freshwater can (option, chap. 15.9) You can mount the can on the rear of the unit or place it next to the unit.

	<p><b>In order to ensure accurate humidifying, observe the following points with regard to the freshwater supply:</b></p> <ul style="list-style-type: none"> <li>• Supply pressure 1 to 10 bar / 14.5 to 145 PSI when connecting to a water pipe</li> <li>• Water type: deionized (demineralized) water</li> <li>• To ensure humidification during 24 hours even at high humidity set-points with manual water supply, we recommend filling the freshwater can (option) at the end of each day.</li> <li>• Water intake temperature NOT below +5 °C / 41 °F and not exceeding 40 °C / 104 °F.</li> </ul>
---	--

	<p>BINDER GmbH is NOT responsible for the water quality provided by the customer.</p> <p>Any problems and malfunctions that might arise following use of water of deviating quality is excluded from liability by BINDER GmbH.</p>
---	--

### Automatic freshwater supply via water pipe

With this type of supply, the humidity system is continuously functional.

### Manual freshwater supply via freshwater can (option, chap. 15.9)

With this type of supply, the humidity system is functional only if the water can is sufficiently filled. Check the filling level daily. The water reserve in the can is sufficient for a period, which may last between one and several days, depending on the humidity demand (entered humidity set-point and number of door openings).

### Wastewater

The condensation water from the interior is collected in an internal can with a volume of approx. 0.5 liters. It is pumped off via the wastewater pipe.

### Dehumidifying system

When humidity switch "ON / OFF" (4) (located on the right lateral control panel) is "ON", the constant climate chamber KBF dehumidifies as needed in order to reach the entered humidity set-point" inside the control range of temperature and relative humidity (Figure 21).

Dehumidification occurs in case of need by means of defined dew point undershoot of several evaporators of the refrigeration system. The condensate which forms is carried away as wastewater.

If the humidity system is turned off while there are descending temperature curves, then operation of the refrigeration system may cause dehumidification of the charging material.

For error indications concerning water supply and humidity system, see chap. 11.1 and 18.

### 13. Defrosting at refrigerating operation

BINDER constant climate chambers are very diffusion-proof. To ensure high temperature precision there is no automatic cyclic defrosting device. The DCT™ refrigerating system largely avoids icing of the evaporation plates. However, at very low temperatures the moisture in the air can condense on the evaporator plates leading to icing.

	Always close the door properly.
---	---------------------------------

**Operation with temperature set-points > +5 °C / 41 °F at an ambient temperature of 25 °C / 77 °F:**

The air defrosts the ice cover automatically. Defrosting is continually performed.

**Operation with temperature set-points < +5 °C / 41 °F:**

Icing on the evaporator is possible. Defrost the unit manually.

	<p>With temperature set-points &lt; +5 °C / 41 °F, regularly defrost the unit manually:</p> <ul style="list-style-type: none"> <li>• Set the humidity to 0 % r.H. and turn on the humidifying system at humidity switch (4).</li> <li>• Set the temperature to 40 °C / 104 °F (Manual Mode).</li> <li>• Let the unit operate for about 30 minutes with the door closed.</li> </ul>
---	--

	Too much ice on the evaporator is noticeable by reduced refrigerating performance.
--	--

When turning off the unit following prolonged refrigerating operation below +5 °C / 41 °F, there is danger of overflowing due to uncontrolled defrosting of icing on the evaporator.

	<b>CAUTION</b>
	<p><b>Uncontrolled defrosting of icing on the evaporator.</b></p> <p><b>Danger of overflowing.</b></p> <p>After several days of refrigerating operation below +5 °C / 41 °F:</p> <ul style="list-style-type: none"> <li>⊘ Do NOT directly turn off the unit.</li> <li>➤ Manually defrost the unit (see description above).</li> <li>➤ Then, shut down the unit at the main power switch (3) and close the tap of the water supply.</li> </ul>

## 14. ICH compliant illumination according to CPMP/ICH/279/95 (Q1B)

### 14.1 BINDER ICH light



Pure cool white fluorescent tubes (light color 640 or 840) are used together with the special fluorescent tubes "BINDER Q1B Synergy Light" available only at BINDER, which combine emission of both radiations UVA and cool white. Combination of these tubes leads to a spectral distribution according to option 2 of Guideline CPMP/ICH/279/95 (Q1B).

#### Advantages of the BINDER light system:

- Reaching the radiation doses of UVA and LUX requested by Q1B almost simultaneously.
- After having reached the target intensity of guideline CPMP/ICH/279/95 (Q1B), you can turn off the "BINDER Q1B Synergy Light" fluorescent tubes, which contain a UVA portion, independently from the "cool white" fluorescent tubes emitting in the visible spectral range.
- Optimum homogeneity of the spectral distribution and the intensities in LUX and UVA on the shelf surface, even with high intensity values, obtained by the BINDER ICH light and the special lens of the headlight. This guarantees that all samples receive the same radiation doses, thus permitting very precise test conditions for photo stability tests.

**Fluorescent tube cool white:** T8 fluorescent tube in form of a rod with a tube diameter of 26mm. Length according to chamber size 600 mm / 23.6 in or 900 mm / 35.4 in. Emissive range in the visible spectral range 400 to 800 nm. The relative spectral distribution meets the F6 standard (cool white) acc. to ISO 10977.

**Fluorescent tube "BINDER Q1B Synergy Light":** T8 fluorescent tube in the form of a rod with a tube diameter of 26 mm / 1.02 in. Length according to chamber size 600 mm / 23.6 in or 900 mm / 35.4 in. Emissive range in the visible spectral range 400 to 800 nm. Emissive range in the UVA range 320 to 400 nm.

	 <b>WARNING</b>
	<p><b>UV light hazard.</b>  <b>Eye and skin injury.</b></p> <p>⊘ Do NOT look directly into the light.          ➤ Minimize skin exposure.</p>

The maximum allowed ultraviolet exposure emitted by this unit on unprotected skin or eye shall not exceed 7.7 hours per day.

The waste heat of the fluorescent tubes leads to a modification of the temperature - humidity diagram:

	<p>When operating the chamber with illumination: Restricted temperature and humidity range 20 °C / 68 °F to 60 °C / 140 °F, at 20 °C not below 30 % r.H.</p>
---	--

### 14.2 Adjustable light cassettes

The KBF P is equipped with fluorescent tubes for UVA and the visible spectral range. Special reflector material in the cassettes ensures optimum light diffusion and efficient utilization of the high light intensity. The lens of the headlight leads to a homogeneous intensity distribution even with a short distance to the shelf. The fluorescent tubes are built in light cassettes that can be freely positioned within wide areas. They homogeneously illuminate the racks below them.

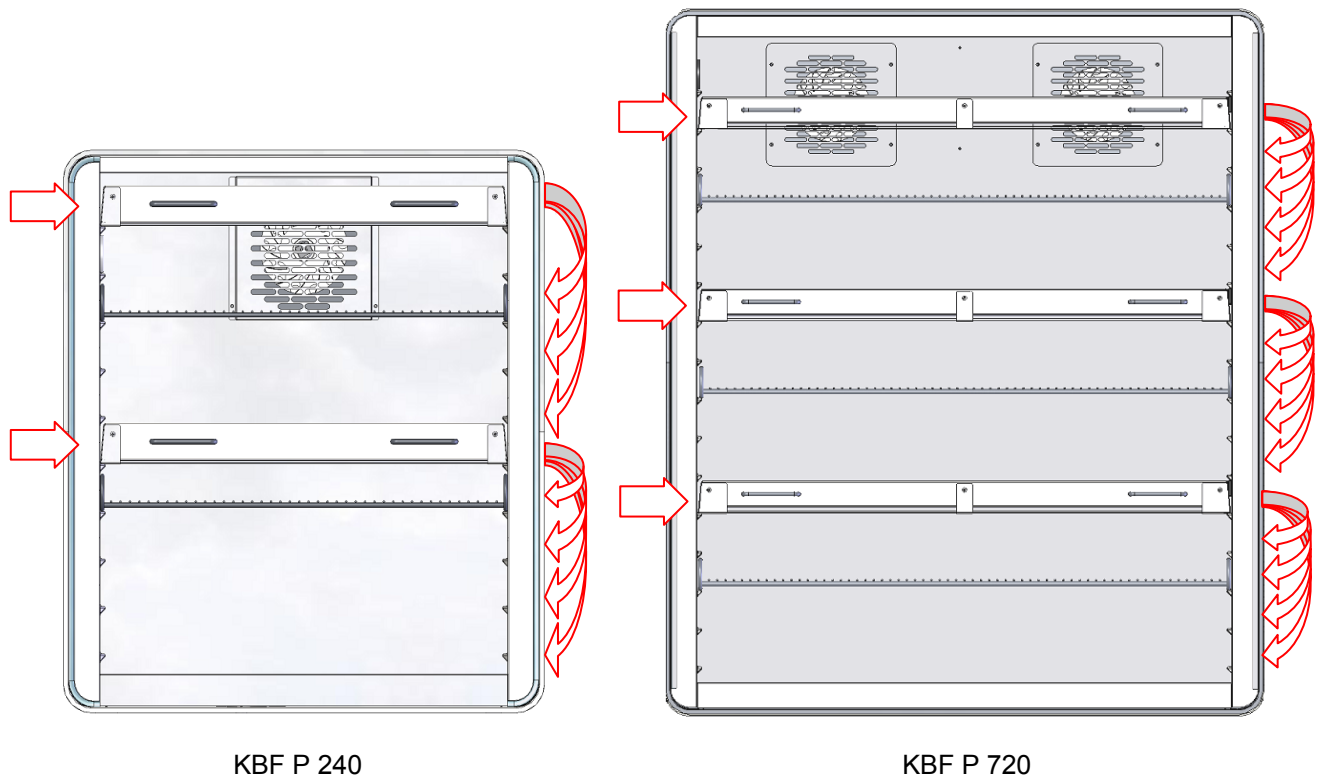



Figure 24: Positions of light cassettes

-  This position is only meant for the light cassettes. Due to their connections, shelves cannot be positioned here.
-  You can move the light cassettes to the indicated positions.

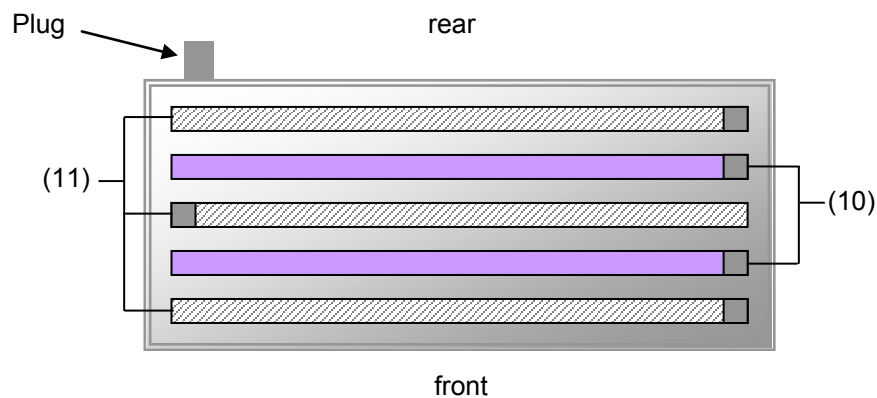

Figure 25: Arrangement of the fluorescent tubes in the light cassette

The fluorescent tubes are turned on by two additional switches (10) and (11) on the left lateral control panel (switches in position "I").

(10) Switch for ICH compliant illumination BINDER Q1B Synergy Light (cool white and UVA)

(11) Switch for ICH compliant illumination cool white

You will obtain optimum homogeneity by alternately placing the fluorescent tubes of the same type, i.e., opposite arrangement of the inscription:



Figure 26: Opposite arrangement of two fluorescent tubes



When replacing the fluorescent tubes, observe tube orientation (inscription).

How to replace the fluorescent tubes is described in chap.16.2.



Operation with light cassettes and illumination on: Maximum temperature 60 °C / 140 °F.

Operation with light cassettes and illumination off: Do also NOT operate the unit at temperatures >60 °C / 140 °F. Otherwise, the lifetime of the fluorescent tubes will be considerably reduced.

When operating the chamber at temperatures > 60 °C / 140 °F, remove the light cassettes.



**Entering the set point values for KBF P when operating without illumination:**

- Adapt the setting of the temperature set-point according to the table in chap. 8.2.
- Adapt the setting of the humidity set-point according to the table in chap. 8.2.

## 15. Options

### 15.1 Communication software APT-COM™ 3 DataControlSystem (option)

The constant climate chamber is regularly equipped with an Ethernet interface (8) that can connect the BINDER communication software APT-COM™ 3 DataControlSystem. The actual temperature and humidity values are given at adjustable intervals. Programming can be performed graphically via PC. Up to 30 chambers with RS 422 interface can be cross-linked. The MAC Address is indicated below the Ethernet interface. For further information, please refer to the operating manual of the BINDER communication software APT-COM™ 3.

The additional RS422 interface (9) is only used for service purposes. Do NOT connect it to any network. The interface is labeled accordingly.

### 15.2 Interface RS 422 (option)

With this option, the chamber is equipped with a serial interface RS 422 instead of the Ethernet Interface, that can connect the BINDER communication software APT-COM™ 3 DataControlSystem. The actual temperature and humidity values are given at adjustable intervals.

Pin allocation of the RS 422 interface:	Pin 2:	RxD (+)
	Pin 3:	TxD (+)
	Pin 4:	RxD (-)
	Pin 5:	TxD (-)
	Pin 7:	Ground

### 15.3 Data logger kits (option)

BINDER Data Logger Kits offer an independent long-term measuring system for temperature and humidity, available for different temperature ranges. According to the selected kit, the Data Logger can measure and record also the ambient temperature and humidity values via a second multi-function sensor.

BINDER Data Loggers are equipped with a keyboard and a large LCD display, alarm functions and a real-time function. Measurement data are recorded in the Data Logger and can be read out after the measurement via the RS232 interface of the Data Logger. It offers a programmable measuring interval and permits storing up to 64000 measuring values. Reading out is done with the Data Logger evaluation software. You can give out a combined alarm and status protocol directly to a serial printer.

**Data Logger Kit TH 70:** Multi-function sensor for chamber temperature and humidity: Temperature range -40 °C / -40 °F up to 70 °C / 158 °F, humidity range 0% r.H. up to 100% r.H.

**Data Logger Kit TH 70/70:** Multi-function sensor for chamber temperature and humidity: Temperature range -40 °C / -40 °F up to 70 °C / 158 °F, humidity range 0% r.H. up to 100% r.H. Multi-function sensor for ambient temperature and humidity: Temperature range -40 °C / -40 °F up to 70 °C / 158 °F, humidity range 0% r.H. up to 100% r.H.



For detailed information on installation and operation of the BINDER Data Logger, please refer to the mounting instructions Art. No. 7001-0204 and to the original user manual of the manufacturer, supplied with the data logger.

## 15.4 Analog outputs for temperature and humidity (option)

With this option the chamber is equipped with analog outputs 4-20 mA for temperature and humidity. These outputs allow transmitting data to external data registration systems or devices.

The connection is realized as a DIN socket (6) in the right lateral control panel as follows:

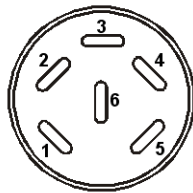

### ANALOG OUTPUT 4-20 mA DC

PIN 1: Temperature –

PIN 2: Temperature +

PIN 3: Humidity –

PIN 4: Humidity +

Humidity range: 0 % r.H. to 100 % r.H.

Temperature range: -10 °C / 14 °F to +100 °C / 212 °F

A suitable DIN plug is enclosed.

Figure 27: Pin allocation of DIN socket (6) for option analog outputs

## 15.5 Zero-voltage relay alarm outputs for temperature and humidity (option)

The chamber equipment with optional zero-voltage relay outputs for temperature and humidity (option) permits the transmission of alarms to a central monitoring system. Connection is established via a DIN socket (7) located on the right lateral control panel.

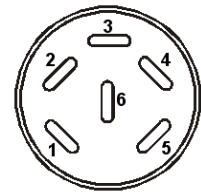
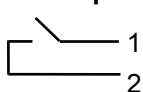
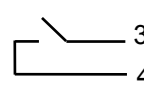



Figure 28: Pin configuration of the DIN socket (7)

Temperature contact	Humidity contact
 <p>1 Pin 1: Pin</p> <p>2 Pin 2: Make</p>	 <p>3 Pin 3: Pin</p> <p>4 Pin 4: Make</p>

In case of a temperature alarm, pins 1 and 2 are open; with humidity alarm, pins 3 and 4 are open. This happens simultaneously with the alarm message shown on the controller display.

In case of power failure, both contacts are open.

**Maximum loading capacity of the switching contacts: 24V AC/DC - 2,5A**

	 <b>DANGER</b>
	<p><b>Electrical hazard.</b></p> <p><b>Danger of death.</b></p> <p><b>Damage to switching contacts and connection socket.</b></p> <ul style="list-style-type: none"> <li>⊘ Do NOT exceed the maximum switching load of 24V AC/DC – 2.5A.</li> <li>⊘ Do NOT connect any devices with a higher loading capacity.</li> </ul>

A temperature and humidity alarm message will remain visible on the controller display during the whole time of the alarm transmission via the zero-voltage relay outputs.

As soon as the cause of the alarm is rectified, you can reset the alarm transmission via the zero-voltage relay outputs together with the alarm message at the controller display by pressing the “RESET” key.

In case of power failure, transmission of the alarm via zero-voltage relay outputs remains active for the duration of the power failure. Afterwards, both contacts will close automatically.





When using the communication software APT-COM™ 3 DataControlSystem (option, chap. 15.1) via the Ethernet interface of the constant climate chamber for data acquisition, the alarm is not automatically transmitted to the APT-COM™ protocol.

- Set the tolerance limits for recording limit value excesses separately in APT-COM™ 3.



## 15.6 Water protected internal socket (option – not for UL units)

The internal socket is splash proof.

IP system of protection 67 230 V 1N ~ 50-60 Hz

Charge max. 500 W

**Maximum permitted operating temperature with this option: 90 °C / 194 °F.**

	 <b>WARNING</b>
	<p><b>Exceeding the permitted maximum temperature.</b></p> <p><b>Electrical hazard.</b></p> <p><b>Danger of death.</b></p> <p><b>Damage to the internal socket.</b></p> <ul style="list-style-type: none"> <li>⊘ Do NOT exceed the temperature set-point of 90 °C / 194 °F.</li> <li>➤ Set the safety controller to 90 °C / 194 °F.</li> <li>➤ With optional temperature safety device, class 3.3, set the mechanical thermostat class 3.1 to 90 °C / 194 °F.</li> </ul>



Heat emission of electrical devices connected inside the chamber may modify the temperature and humidity range.

	<b>CAUTION</b>
	<p><b>Risk of short circuit.</b></p> <p><b>Damage to the unit.</b></p> <ul style="list-style-type: none"> <li>➤ Use the supplied plug only (IP protection type 67). Plug it in and tighten it by screwing to secure contact.</li> <li>➤ If the socket is not used, close the screw lid and turn it to secure.</li> </ul>

## 15.7 Keyboard locking (option)

The keyboard of the MB1 controller can be locked and unlocked via the key switch (option). In the locked position, no entries to the controller are possible.

- Locked keyboard: Switch position vertical
- Unlocked keyboard: Switch position to the right

Only when the keyboard is locked, the key can be removed.

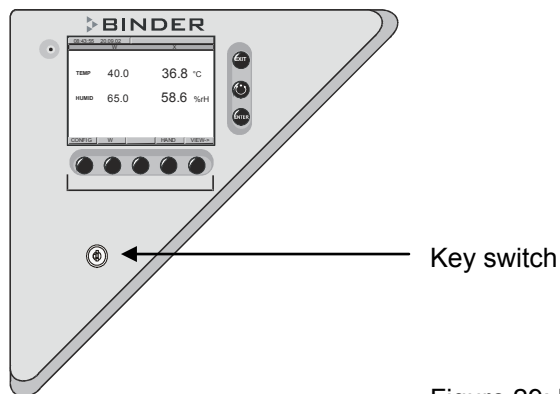

Figure 29: Keyboard locking

If the keyboard is locked, the notification “KEY LOCK” is displayed on the MB1 controller display (chap. 11).

## 15.8 Additional flexible Pt 100 temperature sensor (option)

An additional flexible Pt 100 temperature sensor allows measuring the temperature of the charging material by means of an independent measuring system utilizing Pt 100 entry. The Pt 100 sensor’s top protective tube can be immersed into liquid substances.



### Pt 100 Sensor

PIN 1: Pt 100

PIN 2: Pt 100

PIN 3: Pt 100

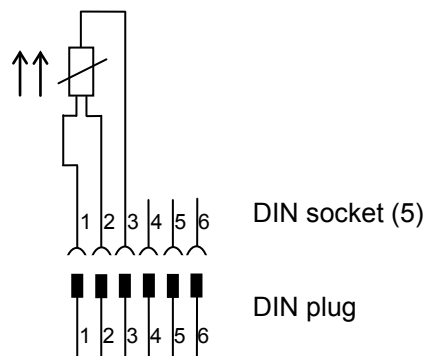

A suitable DIN plug is enclosed.

Figure 30: Pin configuration of the DIN socket (5) in the right lateral control panel

### Technical data of the Pt100 sensor:

- Three-wire technique
- Class B (DIN EN 60751)
- Temperature range up to 320 °C / 608 °F
- Stainless steel protective tube 45 mm / 1.8 in length, material no. 1.4501 / AISI F55

## 15.9 External freshwater and wastewater cans (option)

If no suitable in-house water connection is available, you can manually supply water by filling the optional external freshwater can. There is an additional external water can for the wastewater. Volume: 20 liters / 0.71 cu.ft.

The cans are placed in holding devices. You can affix them directly at the rear of the unit or place them next to the unit.

Figure 31: Rear view KBF / KBF P with installed external water cans (option)

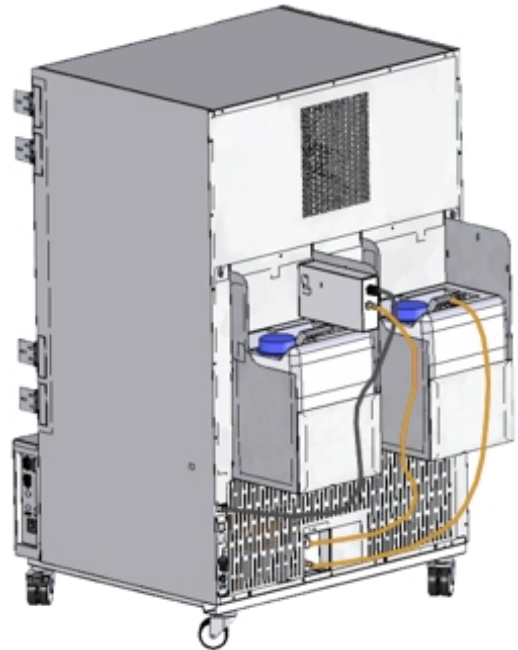

### 15.9.1 Mounting the freshwater can

#### (1) Fixing (if required)

Hang the can with its holding device on its 4 carriers. You can install it either at the left or the right side.

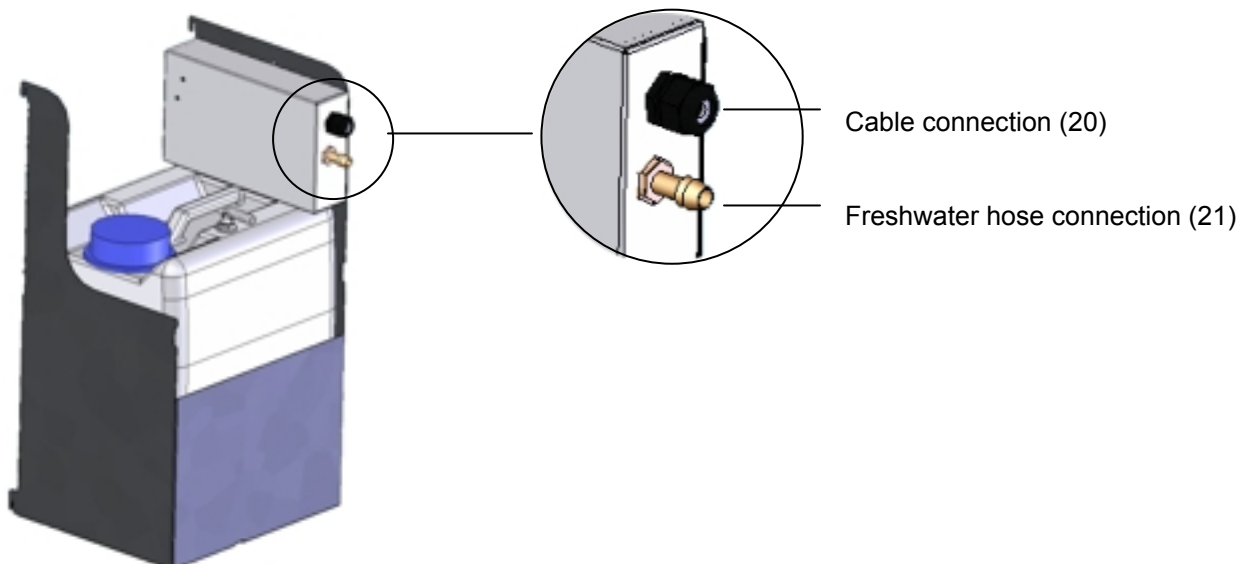

Figure 32: Freshwater can (option)

**(2) Cable connections**

Connect the plug of the cable to the socket (22) at the rear of the unit.

The socket (22) is marked with a sticker:

**WATER TANK  
24 VDC/MAX 0.2A**

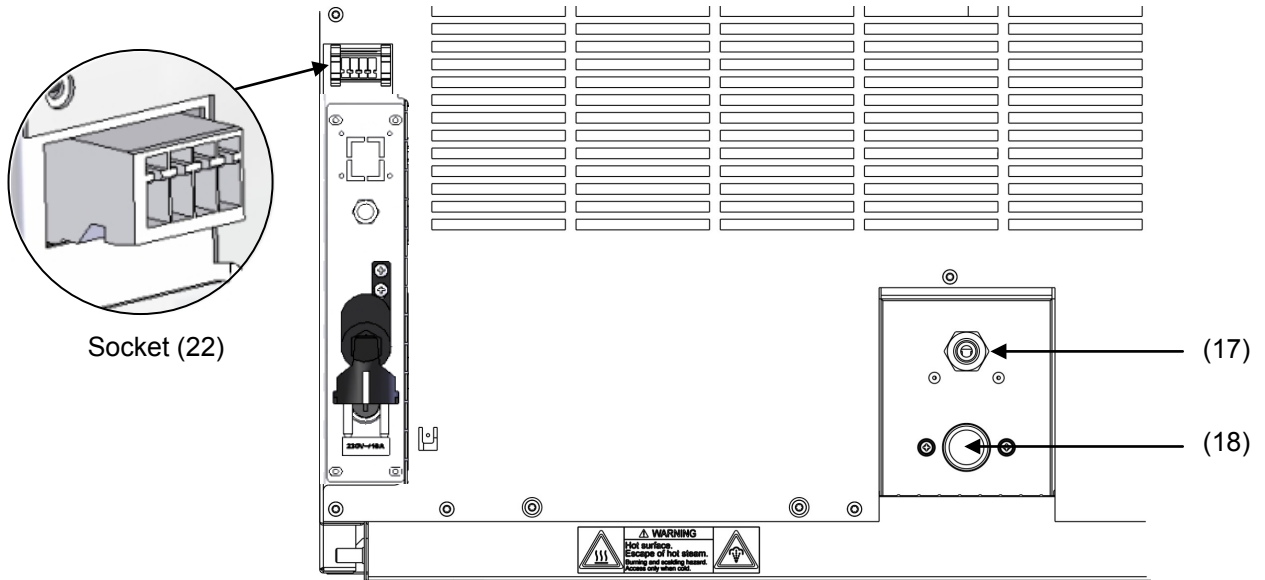



Figure 33: Connections at the unit rear KBF / KBF P 240

**(3) Hose connections**

Plug the freshwater hose into the hose connection (21) above the freshwater can and secure it with a hose clamp. You can use a part of the standard supplied water hose.

Screw the hose nozzle (brass) to the free edge of the hose and screw it directly onto the freshwater connection "IN" (18) at the rear of the unit.

When the freshwater can is empty, within 60 seconds the alarm message "HUMID ALARM" will be displayed on the controller, the buzzer sounds (chap. 11), and the humidity system turns off.

 To guarantee humidification during 24 hours even at high humidity set-points with manual water supply, we recommend filling the freshwater can (option) at the end of each day.

## 15.9.2 Mounting the wastewater can

### (1) Fixing (if required)

Hang the can with its holding device on its 4 carriers at the free space next to the freshwater can.

### (2) Hose connections

Plug the wastewater hose to the hose connection (23) of the can and secure it with a hose clamp. You can use a part of the standard supplied water hose.

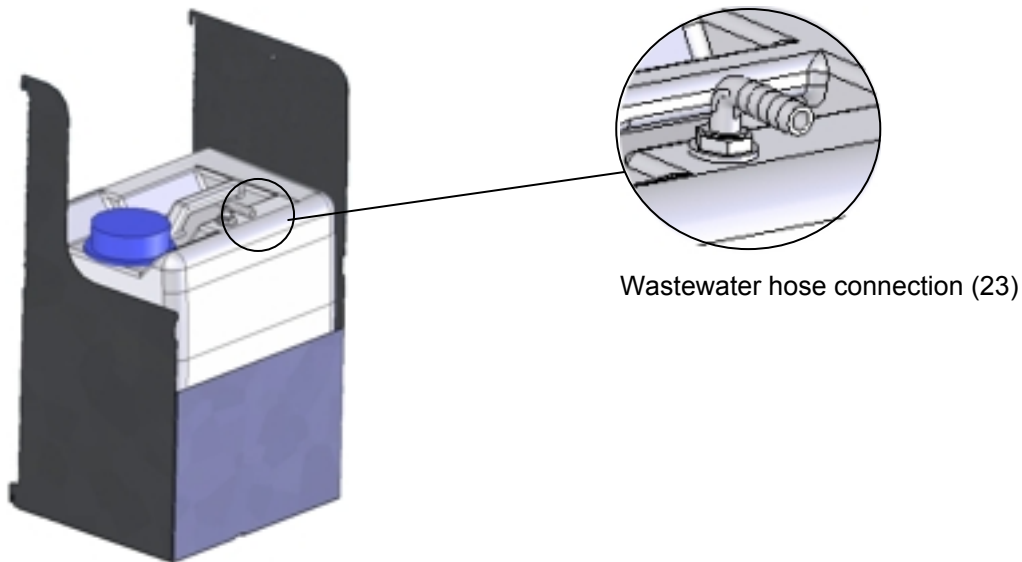



Figure 34: Wastewater can (option)

Plug the free hose edge to the wastewater connection "OUT" (17) at the rear of the unit and secure it with a hose clamp.

You can remove the wastewater can with its holding device for emptying (disconnect the hose first before emptying).

	<b>CAUTION</b>
	<p><b>Overflow of the wastewater can.</b>  <b>Damage to the surrounding.</b></p> <p>➤ Empty the wastewater can in a timely manner before it is full.</p>

	<p>Bringing a source of humidity into the inner chamber may increase wastewater production. Regularly check the filling level of the wastewater can.</p>
---	--

### 15.9.3 Mounting with wastewater recycling

When the chamber interior is clean, you can reuse the wastewater from the unit. Connect the wastewater connection of the chamber (17) with the freshwater hose connection (24) of the freshwater can. The wastewater can is not used in this case.

	<b>CAUTION</b>
	<p><b>Soiling of the vapor humidification system.</b></p> <p><b>Damage to the unit.</b></p> <ul style="list-style-type: none"> <li>➤ Reuse wastewater <b>ONLY</b> with a clean chamber interior.</li> <li>➤ In case of soiling / contamination of the interior, conduct the wastewater to the wastewater connection or use the wastewater can.</li> </ul>

**(1) Fixing of the freshwater can (if required)**

Hang the can with its holding device on its 4 carriers. You can install it either at the left or the right side.

**(2) Cable connections of the freshwater can**

Connect the plug of the cable to the socket (22) at the rear of the unit as described in chap. 15.9.1.

**(3) Hose connections**

Plug the wastewater hose into the hose connection (24) of the freshwater can and secure it with a hose clamp. You can use a part of the standard supplied water hose.

Plug the free hose edge to the wastewater connection "OUT" (17) at the rear of the unit and secure it with a hose clamp.

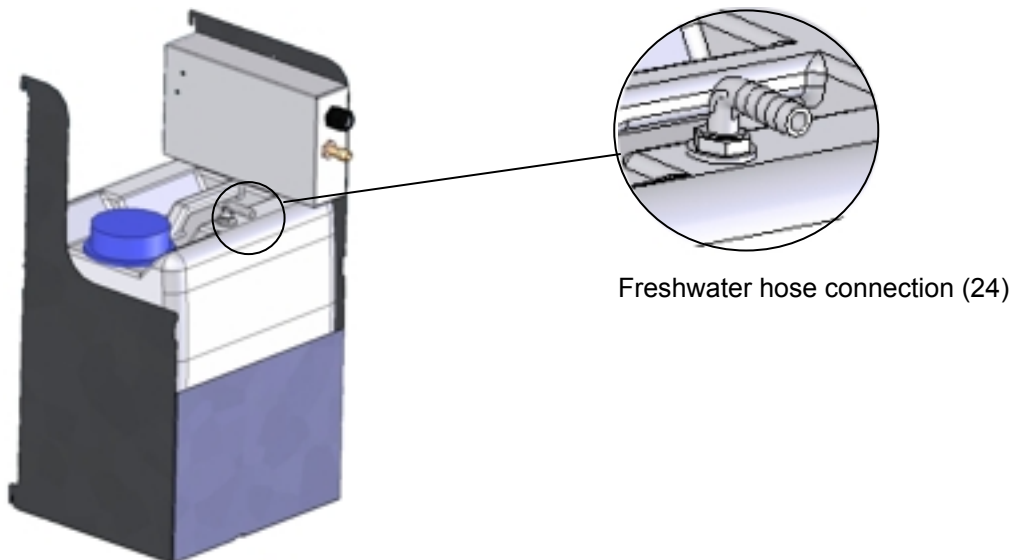



Figure 35: Freshwater can (option)

	<p>Bringing a source of humidity into the inner chamber may increase wastewater production. Regularly check the filling level of the freshwater can.</p>
---	--



## 15.10 BINDER Pure Aqua Service (option)

The optional BINDER water treatment system (disposable unit) is available to treat tap water. The lifetime of the unit depends on water quality and the amount of treated water used. The measuring equipment to assess the water quality is reusable.

	<p>For detailed information on operating the water treatment system BINDER Pure Aqua Service and its function, please refer to the operating manual Art. No. 7001-0269, delivered with BINDER Pure Aqua Service.</p>
---	--

## 16. Maintenance, cleaning, and service

### 16.1 Maintenance intervals, service

	 <b>DANGER</b>	
	<p><b>Electrical hazard.</b> <b>Danger of death.</b></p> <ul style="list-style-type: none"> <li>Ø The unit must NOT become wet during operation or maintenance works.</li> <li>Ø Do NOT remove the rear panel of the unit.</li> <li>➤ Before conducting maintenance work, turn off the unit at the main power switch and disconnect the power plug.</li> <li>➤ General maintenance work must be conducted by licensed electricians or experts authorized by BINDER.</li> <li>➤ Maintenance work at the refrigeration system must only be conducted by qualified personnel who underwent training in accordance with EN 13313:2010 (e.g. a refrigeration technician with certified expert knowledge acc. to regulation 303/2008/EC). Follow the national statutory regulations.</li> </ul>	

Ensure regular maintenance work is performed at least once a year and that the legal requirements are met regarding the qualifications of service personnel, scope of testing and documentation. All work on the refrigeration system (repairs, inspections) must be documented.

	<p>The warranty becomes void if maintenance work is conducted by non-authorized personnel.</p>
---	--

Have conducted regular maintenance work on the steam humidifier at least once a year. The operating behavior and the maintenance intervals of the humidifier essentially depend on the available water quality and the amount of steam produced in the meantime.

	<p>We recommend cleaning the condensers at least twice a year. A qualified technician must perform cleaning.</p>
---	--

	<p>Replace the door gasket only when cold. Otherwise, the door gasket may become damaged.</p>
---	---

With an increased amount of dust in the ambient air, clean the condenser fan (by suction or blowing) several times a year.

We recommend taking out a maintenance agreement. Please consult BINDER Service:

BINDER telephone hotline:	+49 (0) 7462 2005 555
BINDER fax hotline:	+49 (0) 7462 2005 93555
BINDER e-mail hotline:	service@binder-world.com
BINDER service hotline USA:	+1 866 885 9794 or +1 631 224 4340 x3 (toll-free in the USA)
BINDER service hotline Asia Pacific:	+852 390 705 04 or +852 390 705 03
BINDER service hotline Russia and CIS	+7 495 988 15 16
BINDER Internet website	<a href="http://www.binder-world.com">http://www.binder-world.com</a>
BINDER address	BINDER GmbH, post office box 102, D-78502 Tuttlingen

International customers, please contact your local BINDER distributor.

## 16.2 Replacement of the fluorescent tubes

The average life expectancy of the fluorescent tubes is about 10,000 hours. We recommend replacing the tubes every year in order to ensure full light intensity.

To replace the fluorescent tubes, unscrew and remove the clamping strips resting against the glass plate (Allen screwdriver). Then lift the plate from the cassette. Rotate the tubes by 90° and pull them out of their holders. When setting in the new tubes, observe the tube orientation (inscription, Figure 23). Fix the glass plate and then screw in the clamping strips.

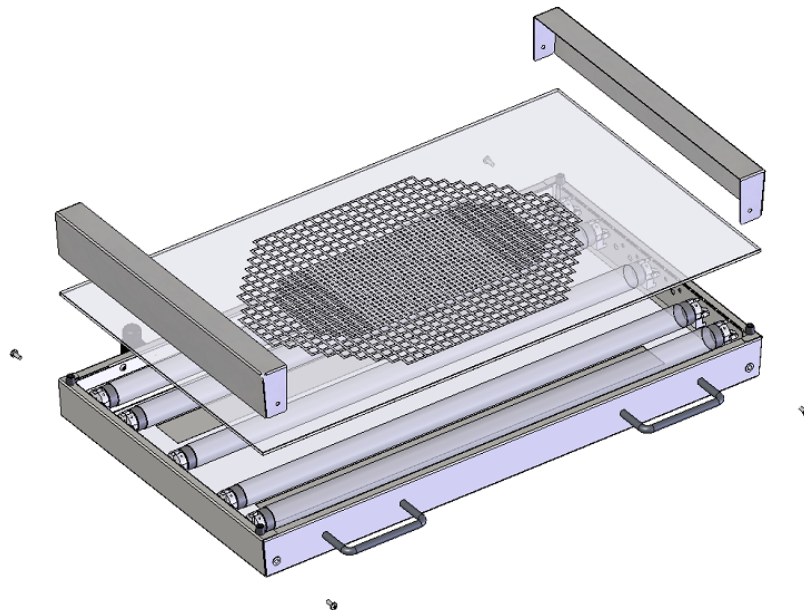

Figure 36: Dismounting a light cassette





Always replace all the fluorescent tubes of a light cassette together. Otherwise, homogeneity of light intensity cannot be assured.



## 16.3 Cleaning and decontamination

Clean the unit after each use to avoid potential corrosion damage by ingredients of the test material.

	 <b>DANGER</b>
	<p><b>Electrical hazard.</b></p> <p><b>Danger of death.</b></p> <ul style="list-style-type: none"> <li>∅ Do NOT spill water or cleaning agents over the inner and outer surfaces</li> <li>➤ Before cleaning, turn off the unit at the main power switch and disconnect the power plug.</li> <li>➤ Completely dry the appliance before turning it on again.</li> </ul>

### 16.3.1 Cleaning

Disconnect the chamber from the power supply before cleaning. Disconnect the power plug.

	The interior of the unit must be kept clean. Thoroughly remove any residues of test material.
---	---

Wipe the surfaces with a moistened towel. In addition, you can use the following cleaning agents:

Exterior surfaces inner chamber racks door gaskets	Standard commercial cleaning detergents free from acid or halides. Alcohol based solutions. We recommend using the neutral cleaning agent Art. No. 1002-0016.
Instrument panel	Standard commercial cleaning detergents free from acid or halides. We recommend using the neutral cleaning agent Art. No. 1002-0016.
Zinc coated hinge parts rear unit wall	Standard commercial cleaning detergents free from acid or halides. Do NOT use a neutral cleaning agent on zinc coated surfaces.

Do not use cleaning agents that may cause a hazard due to reaction with components of the device or the charging material. If there is doubt regarding the suitability of cleaning products, please contact BINDER service.

	<p>We recommend using the neutral cleaning agent Art. No. Art. Nr. 1002-0016 for a thorough cleaning.</p> <p>Any corrosive damage that may arise following use of other cleaning agents is excluded from liability by BINDER GmbH.</p> <p>Any corrosive damage caused by a lack of cleaning, is excluded from liability by BINDER GmbH.</p>
---	---

	<b>CAUTION</b>
	<p><b>Danger of corrosion.</b></p> <p><b>Damage to the unit.</b></p> <ul style="list-style-type: none"> <li>∅ Do NOT use acidic or chlorine cleaning detergents.</li> <li>∅ Do NOT use a neutral cleaning agent on other kind of surfaces e.g., the zinc coated hinge parts or the rear unit wall.</li> </ul>

	<p>For surface protection, perform cleaning as quickly as possible. After cleaning, completely remove cleaning agents from the surfaces with a moistened towel. Let the unit dry.</p>
---	---



	<p>Soapsuds may contain chlorides and must therefore NOT be used for cleaning.</p>
---	--

	<p>With every decontamination method, always use adequate personal safety controls.</p>
---	---

Following cleaning, leave the unit door open or remove the access port plugs.

	<p>The neutral cleaning agent may cause health problems in contact with skin and if ingested. Follow the operating instructions and safety hints labeled on the bottle of the neutral cleaning agent.</p>
---	---

Recommended precautions: To protect the eyes use sealed protective goggles. Suitable protective gloves with full contact: butyl or nitrile rubber, penetration time >480 minutes.

	<p style="text-align: center;"> <b>CAUTION</b></p> <p><b>Contact with skin, ingestion.</b> <b>Skin and eye damage due to chemical burns.</b></p> <ul style="list-style-type: none"> <li>Ø Do not ingest. Keep away from food and beverages.</li> <li>Ø Do NOT empty into drains.</li> <li>➤ Wear protective gloves and goggles.</li> <li>➤ Avoid skin contact.</li> </ul>
--	--

### 16.3.2 Decontamination

The operator must ensure that proper decontamination is performed in case a contamination of the chamber by hazardous substances has occurred.

Disconnect the chamber from the power supply prior to chemical decontamination. Pull the power plug.

Do not use decontamination agents that may cause a hazard due to reaction with components of the device or the charging material. If there is doubt regarding the suitability of cleaning products, please contact BINDER service.

You can use the following disinfectants:

<p>Inner chamber</p>	<p>Standard commercial surface disinfectants free from acid or halides. Alcohol based solutions. We recommend using the disinfectant spray Art. No. 1002-0022.</p>
----------------------	--

	<p>For chemical disinfection, we recommend using the disinfectant spray Art. No. 1002-0022. Any corrosive damage that may arise following use of other disinfectants is excluded from liability by BINDER GmbH.</p>
---	---

	<p>With every decontamination method, always use adequate personal safety controls.</p>
---	---

In case of contamination of the interior by biologically or chemically hazardous material, there are two possible procedures depending on the type of contamination and charging material:





1. Spray the inner chamber with an appropriate disinfectant.

Before start-up, the unit must be absolutely dry and ventilated, as explosive gases may form during the decontamination process.

2. If necessary, have strongly contaminated inner chamber parts removed by an engineer for cleaning, or have them exchanged. Sterilize the inner chamber parts in a sterilizer or autoclave.

	<p>In case of eye contact, the disinfectant spray may cause eye damage due to chemical burns. Follow the operating instructions and safety hints labeled on the bottle of the disinfectant spray.</p>
---	---

Recommended precautions: To protect the eyes use sealed protective goggles.

	<table border="1"> <tr> <td data-bbox="911 712 986 779">  </td> <td data-bbox="1002 723 1169 757"> <b>CAUTION</b> </td> </tr> <tr> <td colspan="2" data-bbox="539 801 994 875"> <p><b>Eye contact.</b> <b>Eye damage due to chemical burns.</b></p> </td> </tr> <tr> <td colspan="2" data-bbox="539 898 895 972"> <p>Ø Do NOT empty into drains. ➤ Wear protective goggles.</p> </td> </tr> </table>		<b>CAUTION</b>	<p><b>Eye contact.</b> <b>Eye damage due to chemical burns.</b></p>		<p>Ø Do NOT empty into drains. ➤ Wear protective goggles.</p>	
	<b>CAUTION</b>						
<p><b>Eye contact.</b> <b>Eye damage due to chemical burns.</b></p>							
<p>Ø Do NOT empty into drains. ➤ Wear protective goggles.</p>							

	<p>After using the disinfectant spray, allow the unit to dry thoroughly, and aerate it sufficiently.</p>
---	--

## 16.4 Sending the unit back to BINDER GmbH

If you return a BINDER product to us for repair or any other reason, we will only accept the product upon presentation of an **authorization number** (RMA number) that has previously been issued to you. An authorization number will be issued after receiving your complaint either in writing or by telephone **prior** to your sending the BINDER product back to us. The authorization number will be issued following receipt of the information below:

- BINDER product type and serial number
- Date of purchase
- Name and address of the dealer from which you bought the BINDER product
- Exact description of the defect or fault
- Complete address, contact person and availability of that person
- Exact location of the BINDER product in your facility
- A contamination clearance certificate (chap. 20) must be faxed in advance

The authorization number must be applied to the packaging in such a way that it can be easily recognized or be recorded clearly in the delivery documents.

	<p>For security reasons we cannot accept a unit delivery if it does not carry an authorization number.</p>
---	--

**Return address:** BINDER GmbH      Gänsäcker 16  
Abteilung Service      78502 Tuttlingen  
Germany

## 17. Disposal

### 17.1 Disposal of the transport packing

Packing element	Material	Disposal
Straps to fix packing on pallet	Plastic	Plastic recycling
Wooden transport box (option) with metal screws	Non-wood (compressed match-wood, IPPC standard)	Wood recycling
	Metal	Metal recycling
Pallet with foamed plastic stuffing	Solid wood (IPPC standard)	Wood recycling
	PE foam	Plastic recycling
Transport box with metal clamps	Cardboard	Paper recycling
	Metal	Metal recycling
Top cover	Cardboard	Paper recycling
Edge protection	Styropor® or PE foam	Plastic recycling
Protection of doors and racks	PE foam	Plastic recycling
Bag for operating manual	PE foil	Plastic recycling
Insulating air cushion foil (packing of optional accessories)	PE foil	Plastic recycling

If recycling is not possible, all packing parts can also be disposed of with normal waste.

### 17.2 Decommissioning

Turn off the main power switch (3) and humidity switch (4). Disconnect the unit from the power supply. Remove the water installation.

	Having turned off the unit by the main power switch (3), always close the tap used for the water supply.
---	--

- Temporal decommissioning: See indications for appropriate storage, chap. 3.3.
- Final decommissioning: Dispose of the unit as described in chap. 17.3 to 17.5.

### 17.3 Disposal of the unit in the Federal Republic of Germany

According to directive 2002/96/EC of the European Parliament and of the Council on waste electrical and electronic equipment (WEEE), BINDER devices are classified as “monitoring and control instruments” (category 9) only intended for professional use“. They must not be disposed of at public collecting points.

The constant climate chamber KBF / KBF P bears the symbol for the marking of electrical and electronic equipment manufactured / placed on the market in the EC after 13 August 2005 and be disposed of in separate collection according to the directive 2002/96/EC on waste electrical and electronic equipment (WEEE) and German national law for electrical and electronic equipment (Elektro- und Elektronikgerätegesetz, ElektroG). WEEE marking: crossed-out wheeled bin with solid bar under. A significant part of the materials must be recycled in order to protect the environment.

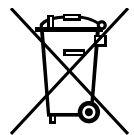



At the end of the device's service life, have the device disposed of according to the German national law for electrical and electronic equipment (Elektro- und Elektronikgerätegesetz, ElektroG) from 23 March 2005, BGBl. I p. 762 or contact BINDER service who will organize taking back and disposal of the unit according to the German national law for electrical and electronic equipment (Elektro- und Elektronikgerätegesetz, ElektroG) from 23 March 2005, BGBl. I p. 762.

	<b>CAUTION</b>
	<p><b>Violation against existing law.</b></p> <ul style="list-style-type: none"> <li>∅ Do NOT dispose of BINDER devices at public collecting points.</li> <li>➤ Have the device disposed of professionally at a recycling company which is certified according to the German national law for electrical and electronic equipment (Elektro- und Elektronikgerätegesetz, ElektroG) from 23 March 2005, BGBl. I p. 762 <i>or</i></li> <li>➤ Instruct BINDER service to dispose of the device. The general terms of payment and delivery of BINDER GmbH apply, which were valid at the time of purchasing the unit.</li> </ul>

Certified companies disassemble waste BINDER equipment in primary substances for recycling according to directive 2002/96/EC. The devices must be free from toxic, infectious or radioactive substances in order to eliminate any health hazards to the employees of the recycling companies.

	<p>Prior to handing the unit over to a recycling company, it is the user's responsibility that it is free from toxic, infectious or radioactive substances.</p> <ul style="list-style-type: none"> <li>• Prior to disposal, clean all introduced or residual toxic substances from the unit.</li> <li>• Prior to disposal, disinfect the unit from all sources of infection. Be aware that sources of infection may also be located outside the inner chamber.</li> <li>• If you cannot safely remove all toxic substances and sources of infection from the unit, dispose of it as "special" waste according to national law.</li> <li>• Fill out the contamination clearance certificate (chap. 20) and enclose it with the unit.</li> </ul>
---	--

 	<b>WARNING</b>
	<p><b>Contamination of the device with toxic, infectious or radioactive substances.</b></p> <p><b>Danger of intoxication.</b></p> <p><b>Danger of infection.</b></p> <ul style="list-style-type: none"> <li>∅ NEVER take a unit contaminated with toxic substances or sources of infection for recycling according to directive 2002/96/EC.</li> <li>➤ Prior to disposal, remove all toxic substances and sources of infection from the unit.</li> <li>➤ Dispose of a unit from which all toxic substances or sources of infection cannot be safely removed as "special" waste according to national law.</li> </ul>

The refrigerant used R 134A (1,1,1,2-tetrafluoroethane) is not inflammable at ambient pressure. It must not escape into the environment. In Europe, recovery of the refrigerant R 134A (1300) is mandatory according to regulation No. 842/2006/EC. Ensure the compliance with the applicable legal requirements regarding qualification of staff, disposal, and documentation.

## 17.4 Disposal of the unit in the member states of the EC except for the Federal Republic of Germany

According to directive 2002/96/EC of the European Parliament and of the Council on waste electrical and electronic equipment (WEEE), BINDER devices are classified as "monitoring and control instruments" (category 9) only intended for professional use". They must not be disposed of at public collecting points.

The constant climate chamber KBF / KBF P bears the symbol for the marking of electrical and electronic equipment manufactured / placed on the market in the EC after 13 August 2005 and be disposed of in separate collection according to the directive 2002/96/EC on waste electrical and electronic equipment (WEEE). WEEE marking: crossed-out wheeled bin with solid bar under.

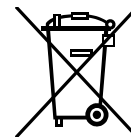



At the end of the device's service life, notify the distributor who sold you the device, who will take back and dispose of the unit according to the directive 2002/96/EC of 27 January 2003 on waste electrical and electronic equipment (WEEE).

	<b>CAUTION</b>
	<p><b>Violation against existing law.</b></p> <ul style="list-style-type: none"> <li>⊘ Do NOT dispose of BINDER devices at public collecting points.</li> <li>➤ Have the device disposed of professionally at a recycling company that is certified according to conversion of the directive 2002/96/EC into national law. <i>or</i></li> <li>➤ Instruct the distributor who sold you the device to dispose of it. The agreements apply that were agreed with the distributor when purchasing the unit (e.g. his general terms of payment and delivery).</li> <li>➤ If your distributor is not able to take back and dispose of the unit, please contact BINDER service.</li> </ul>



Certified companies disassemble waste BINDER equipment in primary substances for recycling according to directive 2002/96/EC. The devices must be free from toxic, infectious or radioactive substances in order to eliminate any health hazards to the employees of the recycling companies.

	<p>Prior to handing the unit over to a recycling company, it is the user's responsibility that it is free from toxic, infectious or radioactive substances.</p> <ul style="list-style-type: none"> <li>• Prior to disposal, clean all introduced or residual toxic substances from the unit.</li> <li>• Prior to disposal, disinfect the unit from all sources of infection. Be aware that sources of infection may also be located outside the inner chamber.</li> <li>• If you cannot safely remove all sources of infection and toxic substances from the unit, dispose of it as "special" waste according to national law.</li> <li>• Fill out the contamination clearance certificate (chap. 20) and enclose it with the unit.</li> </ul>
---	--

 	<b>WARNING</b>
	<p><b>Contamination of the device with toxic, infectious or radioactive substances.</b></p> <p><b>Danger of intoxication.</b></p> <p><b>Danger of infection.</b></p> <ul style="list-style-type: none"> <li>⊘ NEVER take a unit contaminated with toxic substances or sources of infection for recycling according to directive 2002/96/EC.</li> <li>➤ Prior to disposal, remove all toxic substances and sources of infection from the unit.</li> <li>➤ Dispose of a unit from which all toxic substances or sources of infection cannot be safely removed as "special" waste according to national law.</li> </ul>

The refrigerant used R 134A (1,1,1,2-tetrafluoroethane) is not inflammable at ambient pressure. It must not escape into the environment. In Europe, recovery of the refrigerant R 134A (1300) is mandatory according to regulation No. 842/2006/EC. Ensure the compliance with the applicable legal requirements regarding qualification of staff, disposal, and documentation.

## 17.5 Disposal of the unit in non-member states of the EC

 	<b>CAUTION</b>
	<p><b>Alteration of the environment.</b></p> <ul style="list-style-type: none"> <li>➤ For final decommissioning and disposal of the constant climate chamber, please contact BINDER service.</li> <li>➤ Follow the statutory regulations for appropriate, environmentally friendly disposal.</li> </ul>

The main board of the constant climate chamber includes a lithium cell. Please dispose of it according to national regulations.

The refrigerant used R 134A (1,1,1,2-tetrafluoroethane) is not inflammable at ambient pressure. It must not escape into the environment. In Europe, recovery of the refrigerant R 134A (1300) is mandatory according to regulation No. 842/2006/EC. Ensure the compliance with the applicable legal requirements regarding qualification of staff, disposal, and documentation.

## 18. Troubleshooting

Fault description	Possible cause	Required measures
<b>Heating</b>		
Chamber heating permanently, set-point not maintained.	Controller defective.	Contact BINDER service.
	Semiconductor relay defective.	
Chamber doesn't heat up.	Controller not well adjusted, or adjustment interval exceeded.	Calibrate and adjust controller.
	Pt 100 sensor defective.	Contact BINDER service.
	Heating element defective.	
Chamber doesn't heat up when turned on. Safety controller responds.	Semiconductor relay defective	
	Limit temperature reached. Safety controller (chap. 10.2) set too low.	Let the chamber cool down and hit "RESET" button of MB1 controller. If appropriate, select suitable limit value.
Unit without function.	Safety controller (chap. 10.2) defective.	Contact BINDER service.
	No power supply.	Check connection to power supply.
	Wrong voltage.	Check power supply for voltage of 115V or 230V.
	Unit fuse has responded.	Check unit fuse and replace it if appropriate. If it responds again, contact BINDER service.
	Controller defective.	Contact BINDER service.
Nominal temperature exceeded by 10° due to unit failure. Over temperature protective device (class 1) responds.		



Fault description	Possible cause	Required measures
<b>Heating (continued)</b>		
Mechanical safety device class 3.1 responds (with option safety device class 3.3).	Limit temperature reached.	Check setting of temperature set-point and of safety device class 3.1. If appropriate, select suitable limit value.
	Too much external heat load.	Reduce heat load.
	Controller defective.	Contact BINDER service.
	Safety device defective.	
Semi-conductor relay defective		
Mechanical safety device class 3.2 responds (with option safety device class 3.3).	Limit temperature reached.	Check setting of temperature set-point and of safety device class 3.2. If appropriate, select suitable limit value.
	Controller or safety device defective.	Contact BINDER service.
<b>Refrigerating performance</b>		
Low or no refrigerating performance.	Ambient temperature > 25 °C / 77 °F (chap.3.4).	Select cooler place of installation.
	Combination of temperature/humidity values not in the optimum range (see temperature humidity diagram, Figure 21).	Select combination of temperature/humidity values in the optimum range (chap. 12).
	Compressor not turned on.	Contact BINDER service.
	Electro-valves defective.	
	No or not enough refrigerant.	
Too much external heat load.	Reduce heat load.	
<b>Humidity</b>		
Humidity fluctuation: Control accuracy of ± 3 % r.H. is not reached.	Door gasket defective.	Replace door gasket.
	Door opened very frequently.	Open doors less frequently.
Humidity fluctuation, together with temperature fluctuation > 1 °C with a set-point approx. 3 °C above ambient temperature.	Place of installation too hot.	Select cooler place of installation or contact BINDER service.
Low or no dehumidification.	Capillary tube blocked	Contact BINDER service.
	Not enough refrigerant.	
Icing at the evaporator plates.	Set-point was too long below ambient temperature.	Defrost the unit (chap. 13).
Condensation at the walls of the inner chamber.	Combination of temperature/humidity values not in the optimum range (see temperature humidity diagram, Figure 21)	Select combination of temperature/humidity values in the optimum range (chap. 12).
	Set-point was too long below ambient temperature, icing in the preheating chamber.	Defrost the unit (chap. 13)
Low humidity and temperature accuracy.	Fan speed has been reduced.	Set fan speed to 100%.
Notification or alarm message "HUMID SYSTEM" on the controller.	Notification or error of the humidity system.	See chap. 11.2.



Fault description	Possible cause	Required measures
<b>Controller</b>		
No unit function (dark display).	Display mode „Standby“ active.	Press any controller key.
	Main power switch turned off.	Turn on the main power switch.
No entries to controller keypad possible. Notification “KEY LOCK” is displayed	Keyboard locking (option) activated.	Unlock keyboard locking (chap. 15.7).
No access to menu “User settings”.	User code incorrect.	Contact BINDER service.
Wrong temperature alarms, disturbance of temperature accuracy	Temperature unit changed to °F.	Set temperature unit to °C (chap. 6.4).
Chart recorder function: measured-value memory cleared, information lost.	New setting of storage rate.	Change the storage rate ONLY if the previously registered data are no longer required (chap. 7).
Controller does not attain set-points entered in Manual Mode.	Button “EXIT” or “AUTOMATIC” has been hit: Unit is in Idle Mode.	Change to Manual Mode (chap. 8).
Controller does not attain program set-points.	Button “EXIT” or “AUTOMATIC” has been hit: Unit is in Idle Mode.	Start the program again (chap. 9.9).
Program duration longer than programmed.	Tolerances have been programmed.	For rapid transition phases, do NOT program tolerance limits in order to permit maximum heating, refrigerating, or humidification speed.
Program stops one section too early.	Program line is incomplete.	When programming, define the end value of the desired cycle by adding an additional section with a section time of at least one second.
Ramp temperature transitions are only realized as steps.	When using the Program Editor of the software APT-COM™ 3 DataControlSystem, the setting “step” has been selected.	Select setting “ramp” in the Program Editor of the software APT-COM™ 3 DataControlSystem and transfer a program to the chamber controller.
Humidity alarm message when operating without humidity (humidity switch (4) OFF)	Humidity set-point set to a value > 0% r.H.	Manual Mode: Enter a humidity set-point 0% r.H. Program Mode: Enter a humidity subprogram with humidity set-point 0% r.H.
“RESET” button does not cancel the notifying or alarm indication.	Cause of disturbance not removed correctly The “RESET” button permits resetting notifying or alarm messages for temperature and humidity only with in a tolerance sector of +/- 2 °C resp. +/- 5 % r.H.	Remove cause of disturbance. If the “RESET” button still does not cancel the indication, contact BINDER service.
Display flashing: 1999 or -1999 or 9999.	Sensor rupture between sensor and controller or Pt 100 sensor defective.	Contact BINDER service.
	Short-circuit.	
	Initialization problem due to turning on the chamber too early.	Observe a delay time of about 30s between turning the chamber Off and On again.

Fault description	Possible cause	Required measures
<b>Miscellaneous</b>		
Fluorescent tube of ICH compliant illumination (KBF P) does not illuminate.	Defective fluorescent tube.	Replace the fluorescent tubes.
Impaired valve function of hose burst protection.	Calcification.	Remove calcifications by citric acid or acetic acid solutions (chap. 4.3.4). Have a plumber inspect the valve



Only qualified service personnel authorized by BINDER must perform repair.  
Repaired units must comply with the BINDER quality standards.

## 19. Technical description

### 19.1 Factory calibration and adjustment

This unit was calibrated and adjusted in the factory. Calibration and adjustment were performed using standardized test instructions, according to the QM DIN EN ISO 9001 system applied by BINDER (certified since December 1996 by TÜV CERT). All test equipment used is subject to the administration of measurement and test equipment that is also a constituent part of the BINDER QM DIN EN ISO 9001 systems. They are controlled and calibrated to a DKD-Standard at regular intervals.

### 19.2 Over current protection

The devices are equipped with an internal fuse not accessible from outside. If this fuse is blown, please contact an electronic engineer or BINDER service.

### 19.3 Definition of usable volume

The usable volume illustrated below is calculated as follows:

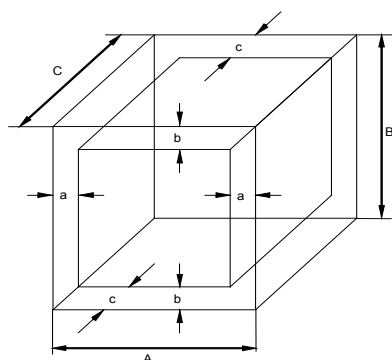

A, B, C = internal dimensions (W, H, D)

a, b, c = distance to wall

$$a = 0.1 * A$$

$$b = 0.1 * B$$

$$c = 0.1 * C$$

$$V_{USE} = (A - 2 * a) * (B - 2 * b) * (C - 2 * c)$$

Figure 37: Determination of the useable volume

Technical data refers to the defined usable volume.



Do NOT place samples outside this usable volume.

Do NOT load this volume by more than half to enable sufficient airflow inside the chamber.

Do NOT divide the usable volume into separate parts with large area samples.

Do NOT place samples too close to each other in order to permit circulation between them and thus obtain a homogenous distribution of temperature and humidity.

## 19.4 KBF Technical Data

Unit size		115	240	720	1020	
<b>Exterior dimensions</b>						
Width	mm / inch	880 / 34.65	925 / 36.42	1250 / 49.21	1250 / 49.21	
Height (incl. feet/castors)	mm / inch	1050 / 41.34	1460 / 57.48	1925 / 75.79	1925 / 75.79	
Depth	mm / inch	650 / 25.59	800 / 31.50	890 / 35.04	1145 / 45.08	
Depth including door handle, I-triangle, connection and 30 mm for cable	mm / inch	730 / 28.74	880 / 34.65	970 / 38.19	1230 / 48.43	
Wall clearance rear (minimum) (spacer)	mm / inch	100 / 3.94	100 / 3.94	100 / 3.94	100 / 3.94	
Wall clearance side (minimum)	mm / inch	100 / 3.94	100 / 3.94	100 / 3.94	100 / 3.94	
Steam space volume	l / cu.ft.	156 / 5.5	348 / 12.3	918 / 32.4	1280 / 45.2	
Quantity of doors		1	1	2	2	
Quantity of inner glass doors		1	1	2	2	
<b>Interior dimensions</b>						
Width	mm / inch	600 / 23.62	650 / 25.60	973 / 38.31	973 / 38.31	
Height	mm / inch	483 / 19.02	785 / 30.91	1250 / 49.21	1250 / 49.21	
Depth	mm / inch	351 / 13.82	485 / 19.09	576 / 22.68	836 / 32.91	
Interior volume	l / cu.ft.	102 / 3.6	247 / 8.7	700 / 24.7	1020 / 36.0	
Quantity of racks (standard / max.)		2/5	2/9	2/15	2/15	
Load per rack	kg / lbs.	30 / 66	30 / 66	45 / 99	45 / 99	
Permitted total load	kg / lbs.	100 / 220	100 / 220	150 / 331	150 / 331	
<b>Temperature data (without humidity)</b>						
Temperature range	°C / °F	0 to +70 / 32 to 158	0 to +70 / 32 to 158	0 to +70 / 32 to 158	0 to +70 / 32 to 158	
Temperature fluctuation	± K	0.1	0.1	0.1	0,5	
Temperature uniformity (variation)	at 25 °C / 77 °F	± K	0.2	0.2	0,2	
	at 40 °C / 104 °F	± K	0.2	0.3	0,2	
Max. heat compensation at 40 °C / 104 °F	W	200	300	600	600	
<b>Climatic data (with humidity)</b>						
Temperature range	°C / °F	+10 to +70 / 50 to 158	+10 to +70 / 50 to 158	+10 to +70 / 50 to 158	+10 to +70 / 50 to 158	
Temperature fluctuation	at 25 °C / 77 °F and 60% r.H.	± K	0.1	0.1	0.1	0,1
	at 40 °C / 104 °F and 75% r.H.	± K	0.1	0.1	0.1	0,1
Temperature uniformity (variation)	at 25 °C / 77 °F and 60% r.H.	± K	0.2	0.3	0.2	0,2
	at 40 °C / 104 °F and 75% r.H.	± K	0.2	0.3	0.2	0,2
Humidity range	% r.H.	10 to 80	10 to 80	10 to 80	10 to 80	
Humidity fluctuation	at 25 °C / 77 °F and 60% r.H.	± % r.H.	≤ 2	1.5	1.5	≤ 1,5
	at 40 °C / 104 °F and 75% r.H.	± % r.H.	≤ 2	1.5	1.5	≤ 1,5

Unit size			115	240	720	1020
<b>Climatic data (with humidity) (continued)</b>						
Recovery time after doors were open for 30 sec.	at 25 °C / 77 °F and 60% r.H.	minutes	15	4	2	11
	at 40 °C / 104 °F and 75% r.H.	minutes	8	5	6	12
<b>Electrical data</b> (model versions KBF115-230V, KBF240-230V, KBF720-230V, KBF1020-230V)						
IP system of protection acc. to EN 60529			20	20	20	20
Nominal voltage (+/-10%)	at 50 Hz power frequency	V	200-230	200-230	200-230	200-230
	at 60 Hz power frequency	V	200-230	200-230	200-230	200-230
Current type			1N~	1N~	1N~	1N~
Power plug			shock proof plug			
Nominal power		kW	2.00	2.10	3.10	3.10
Energy consumption at 40 °C / 104 °F and 75 % r.H.		Wh/h	470	650	620	650
Installation category acc. to IEC 61010-1			II	II	II	II
Pollution degree acc. to IEC 61010-1			2	2	2	2
Over-current release category B, 2 poles		Amp	16	16	16	16
<b>Different electrical data for KBF / KBF-UL constructed for the USA and Canada</b> (model versions KBF115UL-240V, KBF240UL-240V, KBF720UL-240V, KBF1020-240V)						
Nominal voltage (+/-10%)	at 50 Hz power frequency	V	200-240	200-240	200-240	200-240
	at 60 Hz power frequency	V	200-240	200-240	200-240	200-240
Current type			2~	2~	2~	2~
Power plug		NEMA	6-20P	6-20P	6-20P	6-20P
<b>Other data</b>						
Weight (empty)		kg / lbs.	129 / 284	184 / 406	309 / 681	365 / 805
Noise level (mean value)		dB (A)	52	52	53	56
Filling weight of refrigerant R 134A (GWP 1300)		kg	0,180	0,170	0,380	0,410

All technical data is specified for unloaded units with standard equipment at an ambient temperature of +22 °C +/- 3°C / 71.6 °F ± 5.4 °F and a power supply voltage fluctuation of +/-10%. Technical data of KBF 115, 240, and 720 is determined in accordance to BINDER Factory Standard Part 1:2015 following DIN 12880; technical data of KBF 1020 is determined in accordance to BINDER Factory Standard Part 2:2015 and DIN 12880:2007. Technical data refers to 100% fan speed.

**All indications are average values, typical for units produced in series. We reserve the right to change technical specifications at any time.**

	If the chamber is fully loaded, the specified heating up and cooling down times may vary according to the load.
---	---

	Bringing a source of humidity into the inner chamber will affect the minimum humidity specification and may affect the humidity accuracy.
---	---

## 19.5 KBF P Technical Data

Unit size		240	720
<b>Exterior dimensions</b>			
Width	mm / inch	925 / 36.42	1250 / 49.21
Height (incl. castors)	mm / inch	1460 / 57.48	1925 / 75.79
Depth	mm / inch	800 / 31.50	890 / 35.04
Depth including door handle, I-triangle, connection and 30 mm for cable	mm / inch	880 / 34.65	970 / 38.19
Wall clearance rear (minimum) (spacers)	mm / inch	100 / 3.94	100 / 3.94
Wall clearance side (minimum)	mm / inch	100 / 3.94	200 / 7.87
Steam space volume	l / cu.ft.	348 / 12.3	918 / 32.4
Quantity of doors		1	2
Quantity of inner glass doors		1	2
<b>Interior dimensions</b>			
Width	mm / inch	650 / 25.60	973 / 38.31
Height	mm / inch	785 / 30.91	1250 / 49.21
Depth	mm / inch	485 / 19.09	576 / 22.68
Interior volume	l / cu.ft.	247 / 8.7	700 / 24.7
Quantity of racks (standard / max.)		2/7	3/12
Quantity of light cassettes		2	3
Load per rack	kg / lbs.	30 / 66	45 / 99
Permitted total load	kg / lbs.	100 / 220	150 / 331
<b>Temperature data (without humidity)</b>			
Temperature range without light cassettes	°C / °F	0 to +70 / 32 to 158	
Temperature range with light cassettes, with illumination	°C / °F	+10 to +60 / 50 to 140	
Max. heat compensation at 40 °C / 104 °F, with illumination	W	400	1000
<b>Climatic data (with humidity)</b>			
Temperature range without light cassettes	°C / °F	+10 to +70 / 50 to 158	+10 to +70 / 50 to 158
Temperature range with light cassettes, with illumination	°C / °F	+10 to +60 / 50 to 140	+20 to +60 / 68 to 140
Temperature fluctuation with illumination	at 25 °C / 77 °F and 60% r.H.	± K	0.2
	at 40 °C / 104 °F and 75% r.H.	± K	0.2
Temperature uniformity (variation) with illumination	at 25 °C / 77 °F and 60% r.H.	± K	0.6
	at 40 °C / 104 °F and 75% r.H.	± K	0.6
Humidity range without light cassettes	% r.H.	10 to 80	10 to 80
Humidity range with light cassettes, with illumination	% r.H.	10 to 75	10 to 75
Humidity fluctuation with illumination	at 25 °C / 77 °F and 60% r.H.	± % r.H.	1.5
	at 40 °C / 104 °F and 75% r.H.	± % r.H.	2.0
Recovery time after doors were open for 30 sec.	at 25 °C / 77 °F and 60% r.H.	minutes	3
	at 40 °C / 104 °F and 75% r.H.	minutes	4
<b>Illumination data per light cassette</b>			
ICH compliant illumination for photo stability testing *)	Lux	8000	9000
	UVA W/m <sup>2</sup>	1.2	1.6

Unit size			240	720
<b>Electrical data</b> (model versions KBFP240-230V, KBFP720-230V)				
IP system of protection acc. to EN 60529			20	20
Nominal voltage (+/-10%)	at 50 Hz power frequency	V	200-230	200-230
	at 60 Hz power frequency	V	200-230	200-230
Current type			1N~	1N~
Power plug			shock proof plug	
Nominal power		kW	2.40	3.50
Energy consumption at 40 °C / 104 °F and 75 % r.H.		Wh/h	600	2350
Installation category acc. to IEC 61010-1			II	II
Pollution degree acc. to IEC 61010-1			2	2
Over-current release category B, 2 poles		Amp	16	16
<b>Different electrical data for KBF / KBF-UL constructed for the USA and Canada</b> (model versions KBFP240UL-240V, KBFP720UL-240V)				
Nominal voltage (+/-10%)	at 50 Hz power frequency	V	200-240	200-240
	at 60 Hz power frequency	V	200-240	200-240
Current type			2~	2~
Power plug		NEMA	6-20P	6-20P
<b>Other data</b>				
Weight (empty)		kg / lbs.	213 / 470	374 / 825
Noise level (mean value)		dB (A)	52	53
Filling weight of refrigerant R 134A (GWP 1300)		kg	0.575	0.800

\*) Average value, measured at 25 °C / 77 °F with a spherical sensor ( $\pm 10\%$ ) by 12 cm / 4.7 in below the light cassette

All technical data is specified for unloaded units with standard equipment at an ambient temperature of  $+22\text{ °C} \pm 3\text{ °C}$  /  $71.6\text{ °F} \pm 5.4\text{ °F}$  and a power supply voltage fluctuation of  $\pm 10\%$ . Technical data is determined in accordance to BINDER Factory Standard Part 1:2015 following DIN 12880:2007. Technical data refers to 100 % fan speed.

**All indications are average values, typical for units produced in series. We reserve the right to change technical specifications at any time.**

	If the chamber is fully loaded, the specified heating up and cooling down times may vary according to the load.
---	---

	Bringing a source of humidity into the inner chamber will affect the minimum humidity specification and may affect the humidity accuracy.
---	---

## 19.6 Equipment and options (extract)

	<p>To operate the constant climate chamber, use only original BINDER accessories or accessories / components from third-party suppliers authorized by BINDER. The user is responsible for any risk arising from using unauthorized accessories.</p>
---	---

Regular equipment
Microprocessor display program controller with 2-channel technology for temperature and humidity
Ethernet interface for computer communication
Temperature safety device class 3.1 acc. to DIN 12880:2007
Inner glass door with gasket
DCT™ refrigerating system with refrigerant R134a
Microprocessor controlled humidifying and dehumidifying system *) (humidity range, see diagram)
Sizes 240 and 720: four castors (2 lockable)
2 racks, stainless steel
Access port 30 mm with silicone plug
ICH compliant illumination for photo stability testing: ICH light (cool white + BINDER Q1B Synergy Light, 2 light cassettes (KBF P))

Options / accessories
Additional rack, stainless steel
Perforated shelf, stainless steel
Reinforced rack with lockings
Securing elements for fastening of racks (4 pieces)
Light cassette (KBF P)
Set of fluorescent tubes ICH light (cool white + BINDER Q1B Synergy Light) for 1 light cassette (KBF P)
Temperature safety device class 3.3 acc. to DIN 12880:2007
Zero-voltage relay alarm outputs for temperature and humidity with DIN plug 6-poles
Interior lighting (not for UL units)
Keyboard locking (BINDER INDIVIDUAL customized solutions)
Lockable door
Interface RS422
BINDER Data Logger kit for temperature / humidity: TH 70 (chamber values) or TH 70/70 (chamber and ambient values)
Flexible Pt 100 temperature sensor, output to DIN socket
External freshwater and wastewater cans (20 liters / 0.71 cu.ft. each)
BINDER Pure Aqua Service
Exchange cartridge for BINDER Pure Aqua Service
Voltage changer for operation at 115 Volt (option for KBF P 240 and KBF)
Access ports 30 mm, 50 mm, or 100 mm with silicone plug
Water protected internal socket 230 V AC (not for UL units)
Safety kit for water connection with hose burst protection device and reflux protection device, pre-mounted assembly (BINDER INDIVIDUAL customized solutions)
Analog outputs 4-20 mAmp for temperature and humidity with 6 pole DIN socket, DIN plug included
Calibration of temperature and humidity including certificate
Spatial temperature and humidity measurement including certificate
Spatial temperature and humidity measurement acc. to DIN 12880:2007 including certificate
Certificate illumination measurement: Radiometrical measurement in visible and UVA spectral range with documentation of intensity distribution and of qualitative spectral distribution (KBF P)
Qualification folder



\*) A water supply (1 to 10 bar / 14.5 to 145 PSI) is necessary for the installation of the humidifying and de-humidifying system (chap. 4.3). If no suitable house water connection is available, you can manually supply water by filling a freshwater can (option, chap. 15.9). Furthermore, a water drain in a max. distance of 3 meters / 9.8 ft. and a max. height of 1 meter / 3.3 ft. is required (chap. 4.2).

## 19.7 Spare parts and accessories (extract)

	BINDER GmbH is responsible for the safety features of the unit only, provided skilled electricians or qualified personnel authorized by BINDER perform all maintenance and repair, and if components relating to chamber safety are replaced in the event of failure with original spare parts. The user is responsible for any risks arising from using unauthorized accessories/components.
---	---

Unit size	115	240	720	1020
Description	Art. no.			
Rack, stainless steel	6004-0112	6004-0101	6004-0106	6004-0143
Perforated rack, stainless steel	6004-0115	6004-0040	8009-0486	8009-0792
Reinforced rack with rack lockings	8012-0700	8012-0638	8012-0674	8012-0968
Securing elements for additional fastening of racks (4 pieces)	8012-0620	8012-0620	8012-0620	8012-0620
Door gasket for glass door	6005-0204	6005-0149	6005-0198	6005-0198
Door gasket silicone (kettle)	6005-0207	6005-0147	6005-0196	6005-0196
Door gasket silicone (outer door)	6005-0203	6005-0161	6005-0197	6005-0197
Intermediate door gasket silicone	---	---	6005-0192	6005-0250
Light cassette (KBF P)	---	8009-0610	8009-0495	---
Set fluorescent tubes ICH light (cool white + BINDER Q1B Synergy Light) for 1 light cassette (KBF P)	---	8012-0657	8012-0699	---
Replacement glass for light cassette (KBF P)	---	8010-0081	8010-0087	---

Description	Art. no.
Plug for silicon access port d30	6016-0035
Radial fan 200-240V / 50/60 Hz	5013-0088
External freshwater and wastewater cans (20 liters / 0.71 cu.ft. each)	8012-0643
BINDER Pure Aqua Service	8012-0759
Exchange cartridge for BINDER Pure Aqua Service	6011-0165
Safety kit for water connection with hose burst protection device and reflux protection device	BINDER Individual
Voltage changer for operation at 115 Volt (option for KBF P 240 and KBF)	8009-0821
MB1 program controller, screen	5014-0182
MB1 program controller, E/A board	5014-0117
Temperature safety device, class 1 (complete)	8009-0335
Temperature safety device class 3.1, 0 °C / 32 °F to 120 °C / 248 °F	5006-0035
Temperature safety device class 3.2, -40 °C / -40 °F to 160 °C / 320 °F	5006-0026
Temperature sensor 2x Pt 100 straight	5002-0043
Humidity sensor	5002-0143
Data Logger Kit TH 70	8012-0716
Data Logger Kit TH 70/70	8012-0717



Description (continued)	Art. no.
Door switch	5019-0009
Humidification module KBF	8009-0789
Humidification module KBF P	8009-0790
Neutral cleaning agent, 1 kg	1002-0016
Qualification folder KBF	DL014031
Qualification folder KBF P	DL015031

Calibration service KBF	Art. Nr.
Calibration of temperature and humidity including certificate	DL014021
Spatial temperature and humidity measurement including certificate (2-5 measuring points temperature, 1 measuring point humidity)	DL014022
Spatial temperature and humidity measurement including certificate (6-9 measuring points temperature, 1 measuring point humidity)	DL014023
Spatial temperature and humidity measurement including certificate (10-18 measuring points temperature, 1 measuring point humidity)	DL014024
Spatial temperature and humidity measurement including certificate (19-27 measuring points temperature, 1 measuring point humidity)	DL014025
Spatial temperature and humidity measurement acc. to DIN 12880:2007 including certificate (27 measuring points temperature, 9 measuring points humidity)	DL014026

Calibration service KBF P	Art. Nr.
Calibration of temperature and humidity including certificate	DL015021
Spatial temperature and humidity measurement including certificate (2-5 measuring points temperature, 1 measuring point humidity)	DL015022
Spatial temperature and humidity measurement including certificate (6-9 measuring points temperature, 1 measuring point humidity)	DL015023
Spatial temperature and humidity measurement including certificate (10-18 measuring points temperature, 1 measuring point humidity)	DL015024
Spatial temperature and humidity measurement including certificate (19-27 measuring points temperature, 1 measuring point humidity)	DL015025
Spatial temperature and humidity measurement acc. to DIN 12880:2007 including certificate (27 measuring points temperature, 9 measuring points humidity)	DL015026
Certificate illumination measurement: 25 measuring points, intensity measurement in visible and UVA spectral range with documentation of intensity distribution and of qualitative spectral distribution	DL015027

## 19.8 Dimensions KBF 115

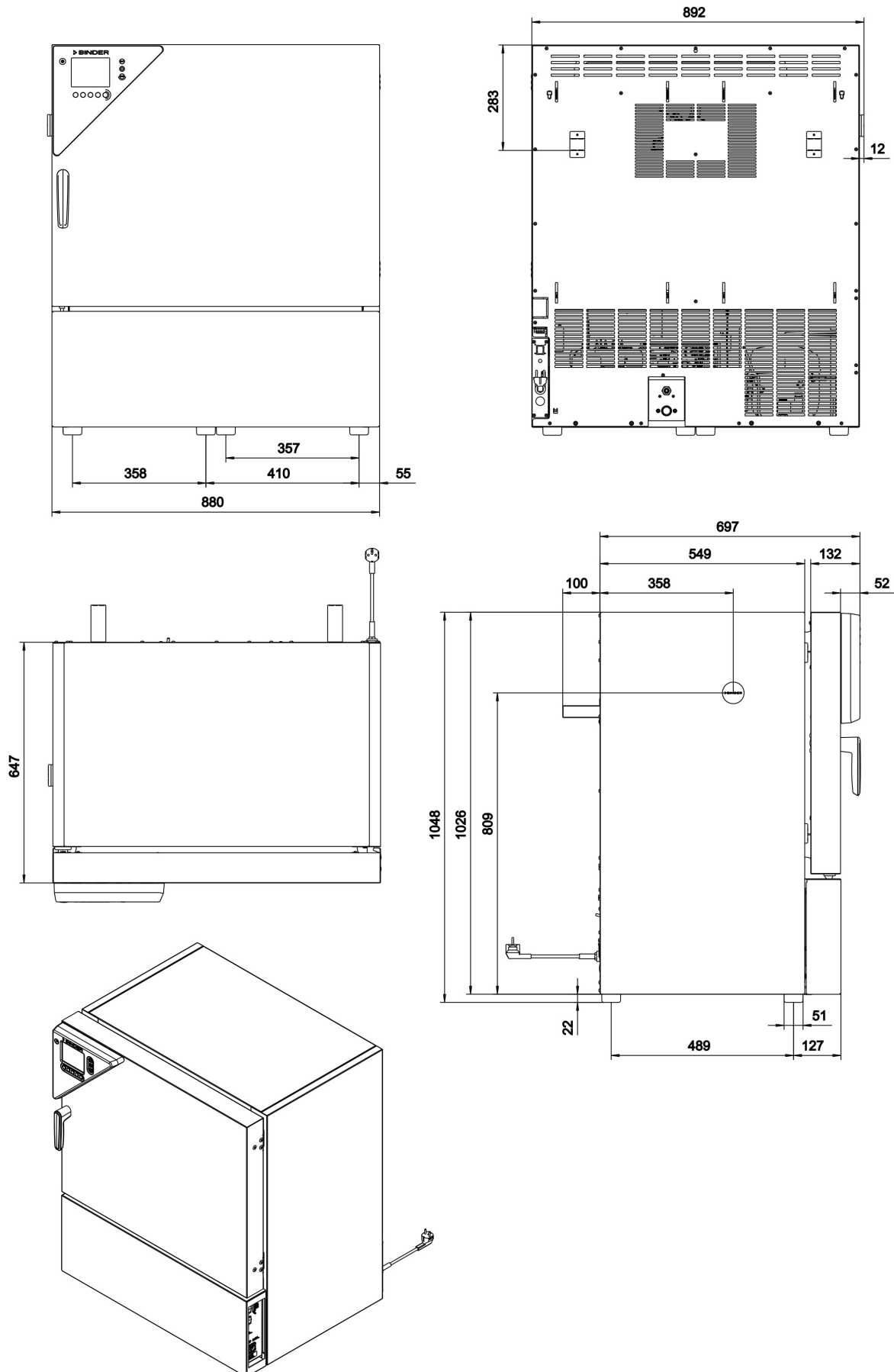

### 19.9 Dimensions KBF 240 / KBF P 240

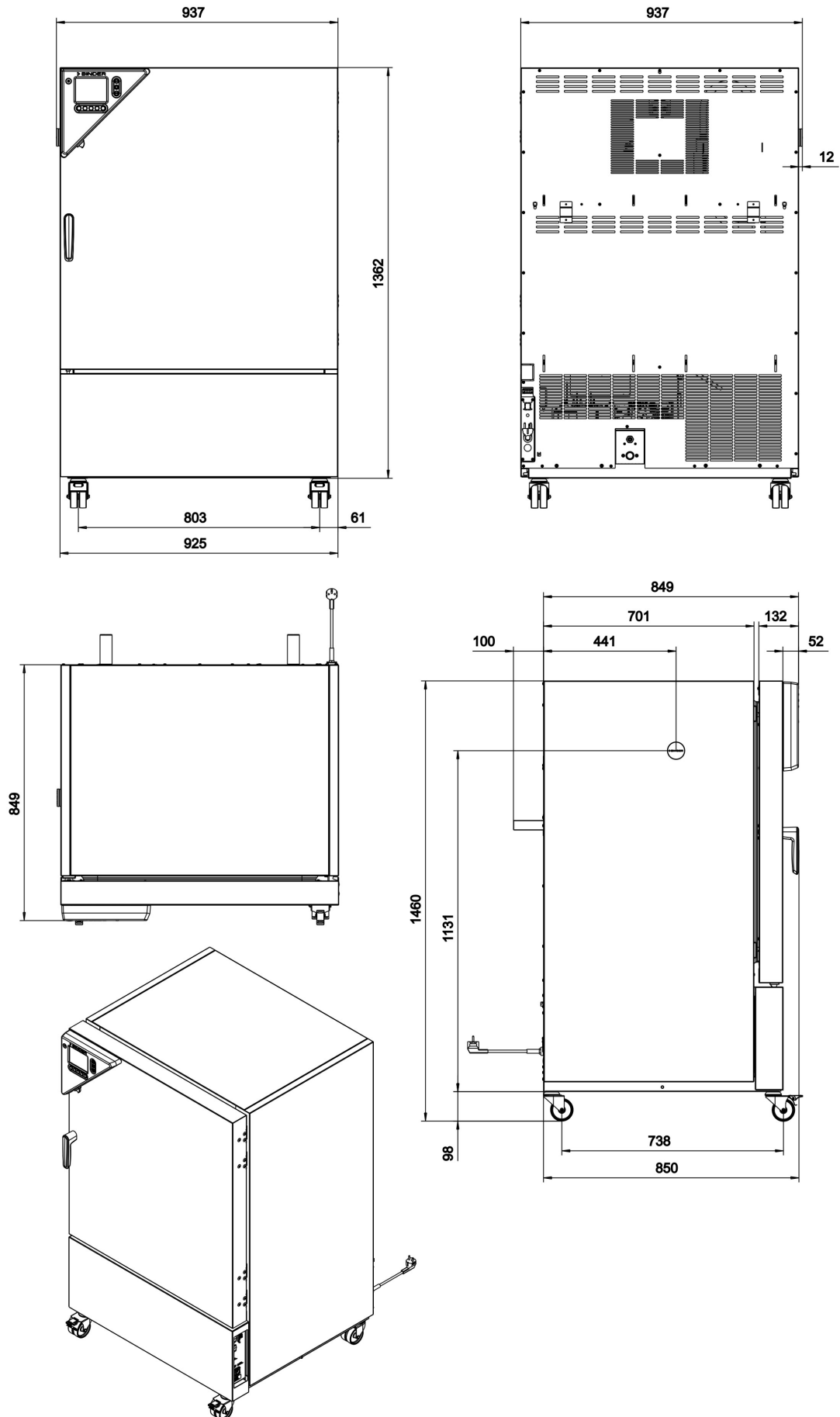

### 19.10 Dimensions KBF 720 / KBF P 720

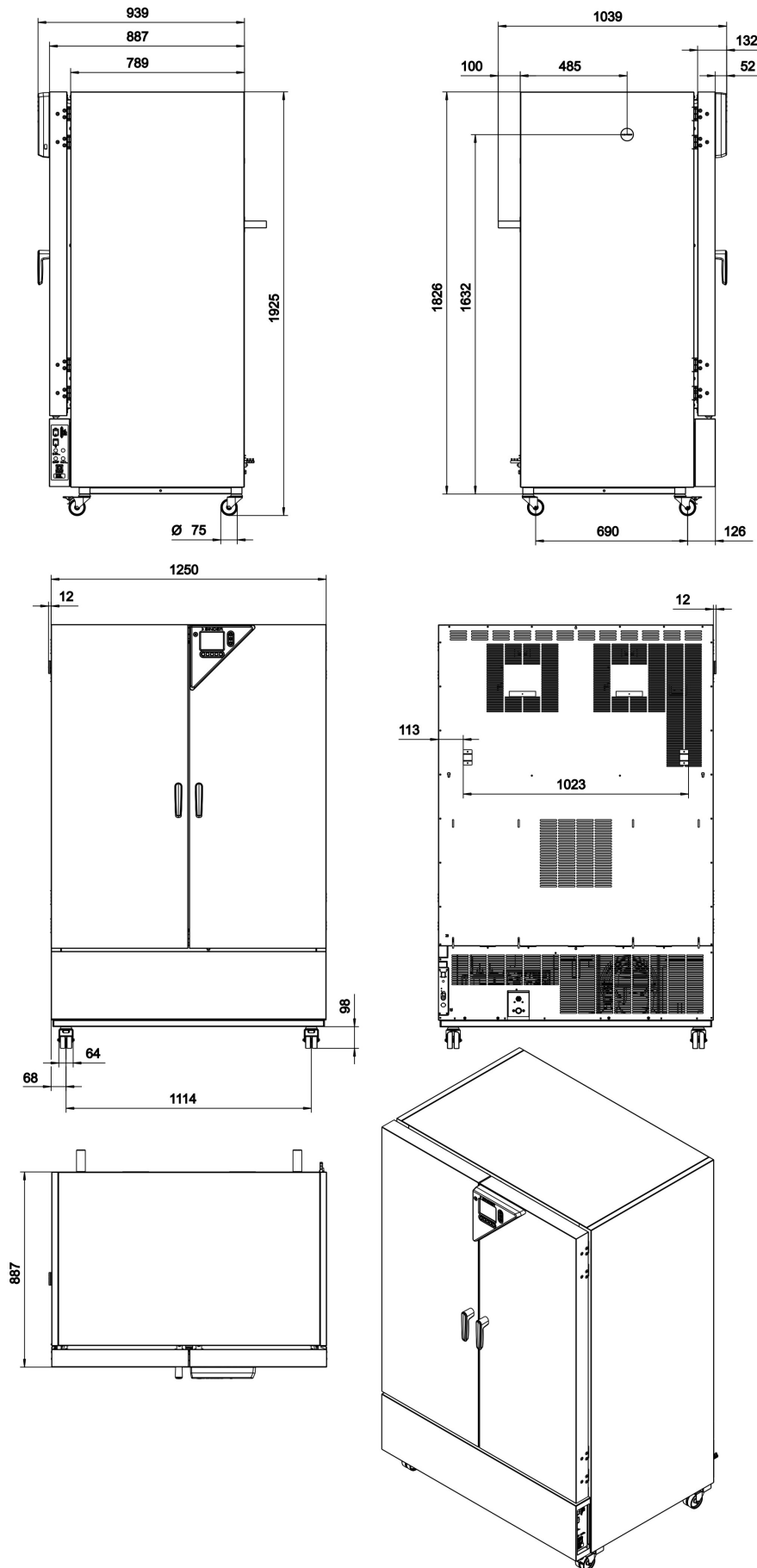

### 19.11 Dimensions KBF 1020

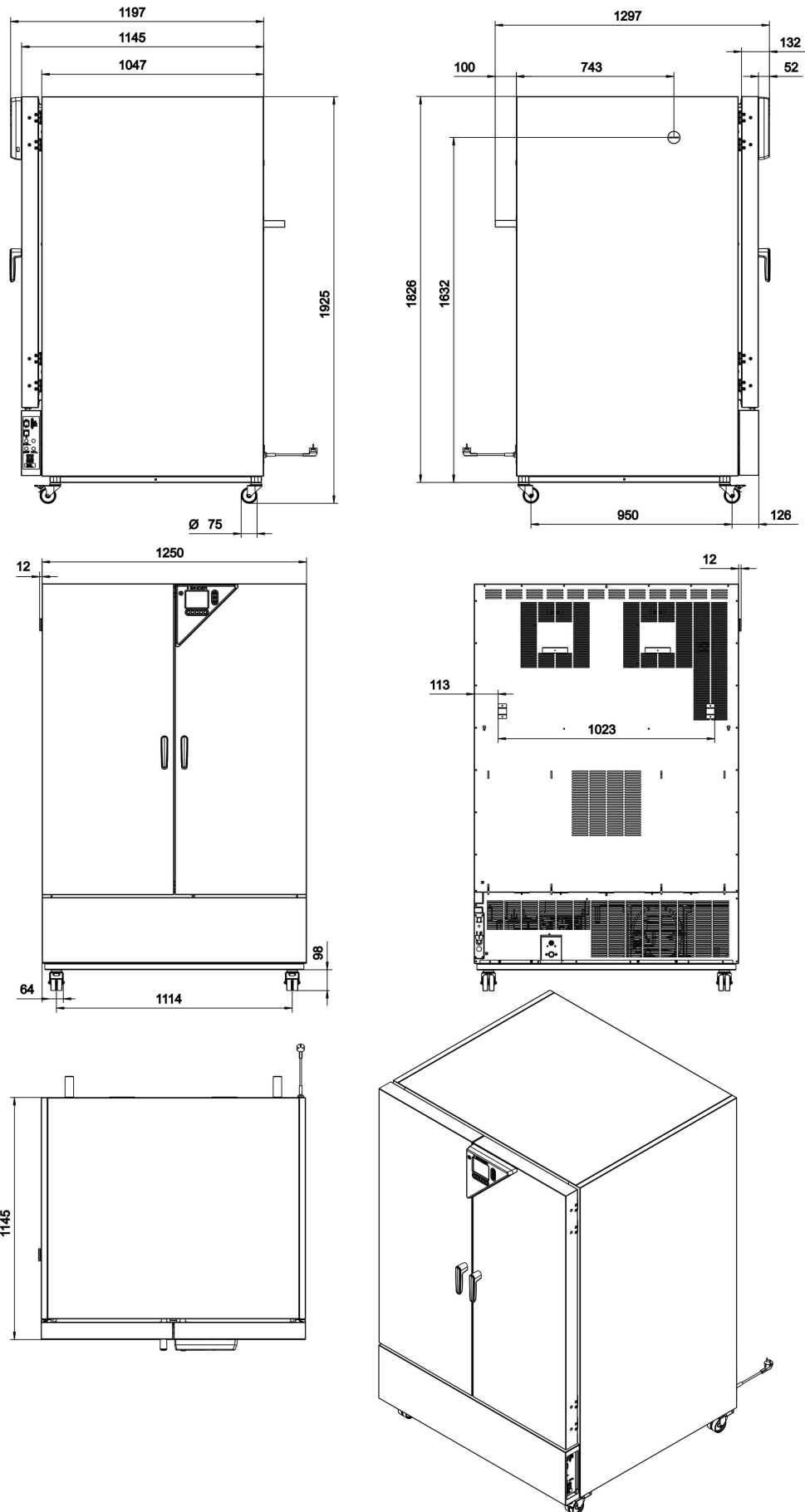

## 20. Certificates

### 20.1 EC Declaration of conformity



Best conditions for your success

	<b>EG-Konformitätserklärung / EC Declaration of Conformity / Déclaration de conformité CE / Declaración de conformidad CE / Dichiarazione di conformità CE / Декларация соответствия ЕС</b>
<b>Hersteller / Manufacturer / Fabricant / Fabricante / Fabricante / Производитель</b>	BINDER GmbH
<b>Anschrift / Address / Adresse / Dirección / Адрес</b>	Im Mittleren Ösch 5, 78532 Tuttlingen, Germany
<b>Produkt / Product / Produit / Producto / Prodotto / Продукт</b>	Konstantklimaschränke Constant climate chambers Enceintes climatiques pour des conditions constantes Cámaras de clima constante Camere per condizioni climatiche costanti Климатическая камера постоянных условий
<b>Typenbezeichnung / Type / Type / Tipo / Tipo / Тип</b>	KBF 115, KBF 240, KBF P 240, KBF 720, KBF P 720, KBF 1020

Die oben beschriebenen Maschinen sind konform mit folgenden EG-Richtlinien (gemäß Veröffentlichung im Amtsblatt der europäischen Kommission):

The machines described above are in conformity with the following EC guidelines (as published in the Official Journal of the European Union):

Les machines décrites ci-dessus sont conformes aux directives CE suivantes (selon leur publication dans le Journal officiel de l'Union européenne):

La máquina descrita arriba cumple con las siguientes directivas de la CE (publicados en el Diario oficial de la Unión Europea):

Le macchine sopra descritte sono conforme alle seguenti direttive CE (secondo la pubblicazione nella Gazzetta ufficiale della Commissione europea):

Машина, указанная выше, полностью соответствует следующим регламентам ЕС (опубликованным в официальном журнале Европейского Содружества):

- **2006/42/EC**  
Maschinenrichtlinie 2006/42/EG / Machinery directive 2006/42/EC / Directive Machines 2006/42/EC / Directiva 2006/42/CE (Máquinas) / Direttiva macchine 2006/42/CE / Директива о машинах 2006/42/EC
- **2004/108/EC**  
EMV-Richtlinie 2004/108/EG / EMC Directive 2004/108/EC / Directive CEM 2004/108/CE / Directiva CEM 2004/108/CE / Direttiva EMC 2004/108/CE / Директива ЭМС 2004/108/EC

Die oben beschriebenen Maschinen entsprechen aufgrund ihrer Konzipierung und Bauart sowie in der von uns in Verkehr gebrachten Ausführung den einschlägigen grundlegenden Sicherheits- und Gesundheitsanforderungen der genannten EG-Richtlinien.

The machines described above are conform to the mentioned EC directives in regard to the relevant safety and health demands due to their conception and their style of construction as well as to the version put onto market by us.

Les machines décrites ci-dessus correspondent aux demandes de sécurité et de santé des directives citées de la Communauté Européenne due à leur conception et construction et dans la réalisation mise sur le marché par nous.

Las máquinas descritas arriba se corresponden con los requisitos básicos pertinentes de seguridad y salud de las citadas directivas de la CE debido a su concepción y fabricación, así como a la realización llevada a cabo por nosotros.

Le macchine sopra descritte sono conforme ai requisiti essenziali di sanità e sicurezza pertinenti delle summenzionate direttive CE in termini di progettazione, tipo di costruzione ed esecuzione messa da noi in circolazione.

Машины описано выше, соответствует указанным директивам ЕС в отношении требований соответствующей безопасности и здоровья по концепции и конструкции так же как и версия, применяемая нами на рынке.

1 / 2

BINDER GmbH Postfach 102 D-78502 Tuttlingen **Hausanschrift:** BINDER GmbH Im Mittleren Ösch 5 D-78532 Tuttlingen  
**Kontakt:** Telefon: +49 (0) 74 62 / 20 05 - 0 | Telefax: +49 (0) 74 62 / 20 05 - 100 | info@binder-world.com | www.binder-world.com  
**Geschäftsführung:** Dipl.-Ing. Peter M. Binder | Amtsgericht Tuttlingen, HRB 385 Tu. | Sitz der Gesellschaft: Tuttlingen  
**Bankverbindung:** Kreissparkasse Tuttlingen Konto-Nr.: 2266 BLZ: 643 500 70 | IBAN-Code: DE05643 500700 000002266 | SWIFT-Code: SOLA DE S1TUT  
 Deutsche Bank Tuttlingen Konto-Nr.: 2 138 709 BLZ: 653 700 75 | IBAN-Code: DE56653 70075 0213870900 | SWIFT-Code: DEUT DE SS603



Die oben beschriebenen Maschinen tragen entsprechend die Kennzeichnung CE.  
The machines described above, corresponding to this, bear the CE-mark.  
Les machines décrits ci-dessus, en correspondance, portent l'indication CE.  
Las maquinas descritas arriba, en conformidad, llevan la indicación CE.  
Le macchine sopra descritte sono contrassegnate dal marchio CE.  
Машины описано выше, в соответствии с изложенным выше маркированы знаком CE.

Die oben beschriebenen Maschinen sind konform mit folgenden harmonisierten Normen:  
The machines described above are in conformity with the following harmonized standards:  
Les machines décrits ci-dessus sont conformes aux normes harmonisées suivantes:  
Las maquinas descritas arriba cumplen con las siguientes normas:  
Le macchine sopra descritte sono conforme alle seguenti normative armonizzate:  
Машины описано выше, полностью соответствуют следующим стандартам:

Sicherheit / Safety / Sécurité / Seguridad / Sicurezza / Нормативы по безопасности
<ul style="list-style-type: none"><li>• EN 61010-1:2010</li><li>• EN 61010-2-010:2003</li><li>• EN ISO 12100:2010 + Corr. 1:2011</li><li>• EN ISO 13732-1:2008</li><li>• EN 60204-1:2006 + A1:2009 + Corr. :2010</li></ul>
EMV / EMC / CEM / CEM / EMC / ЭМС
<ul style="list-style-type: none"><li>• EN 61326-1:2013</li></ul>

78532 Tuttlingen, 19.05.2015  
BINDER GmbH



**P. M. Binder**  
Geschäftsführender Gesellschafter  
Managing Director  
Directeur général  
Director general  
Direttore Generale  
Директор



**J. Bollaender**  
Leiter F & E und Dokumentationsbevollmächtigter  
Director R & D and documentation representative  
Chef de service R&D et autorisé de documentation  
Responsable I & D y representante de documentación  
Direttore R & D e responsabile della documentazione  
Глава департамента R&D представитель документации

2 / 2

## 20.2 Certificate for the GS mark of conformity of the "Deutsche Gesetzliche Unfallversicherung e.V." (German Social Accident Insurance) DGUV

Bescheinigung  
Nr. **NV 15127**  
vom 17.06.2015

 **DGUV Test**  
Prüf- und Zertifizierungsstelle  
Nahrungsmittel und Verpackung  
Fachbereich Nahrungsmittel

### GS-Zertifikat

Name und Anschrift des Bescheinigungsinhabers: (Auftraggeber) **Binder GmbH**  
Im Mittleren Ösch 5  
78532 Tuttlingen

Produktbezeichnung: **Klimaschränke Klima- und Kühlbrutschränke**

Typ: KBF P 240, KBF P 720, KBF LQC 240, KBF LQC 720, KBWF 240, KBWF 720, KBF 115, KBF 240, KBF 720, KMF 115, KMF 240, KMF 720, KBW 240, KBW 400, KBW 720, KB 23, KB 53, KB 115, KB 240, KB 400, KB 720, KBF 1020

Prüfgrundlage: GS-NV 5:2013/06 Prüfgrundsätze für Kühl- und Gefriermaschinen für Industrie und Gewerbe

Zugehöriger Prüfbericht: NV 15127

Weitere Angaben: Das Zertifikat bezieht sich auf die im zugehörigen Prüfbericht beschriebene Ausführung des Produkts.

Das geprüfte Baumuster stimmt mit den in § 21 Absatz 1 des Produktsicherheitsgesetzes genannten Anforderungen überein. Der Bescheinigungsinhaber ist berechtigt, das umseitig abgebildete GS-Zeichen an den mit dem geprüften Baumuster übereinstimmenden Produkten anzubringen. Der Bescheinigungsinhaber hat dabei die umseitig aufgeführten Bedingungen zu beachten.

Diese Bescheinigung einschließlich der Berechtigung zur Anbringung des GS-Zeichens ist gültig bis:  
**16.06.2020**

Weiteres über die Gültigkeit, eine Gültigkeitsverlängerung und andere Bedingungen regelt die Prüf- und Zertifizierungsordnung.



PZB04\_D  
11.14

Deutsche Gesetzliche Unfallversicherung (DGUV) e.V.  
Spitzenverband der gewerblichen Berufsgenossenschaften  
und der Unfallversicherungsträger der öffentlichen Hand  
Vereinsregister-Nr. VR 751 B, Amtsgericht Charlottenburg

DGUV Test Prüf- und Zertifizierungsstelle Nahrungsmittel und Verpackung  
Fachbereich Nahrungsmittel  
Dynamostraße 7 – 11 • 68165 Mannheim • Deutschland  
Telefon: +49 (0) 6 21 44 56-34 30 • Fax: +49 (0) 800 1977 553 16625



Rückseite GS-Zertifikat: NV 15127

**GS-Zeichen**

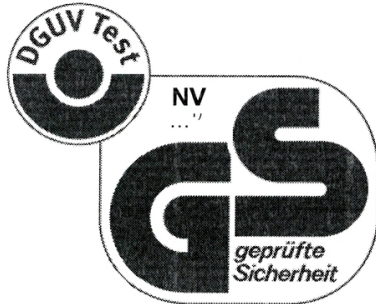

Normalausführung

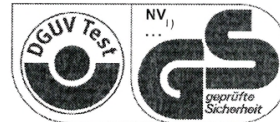

Bei einer Höhe von 20 mm oder weniger  
auch zulässige Ausführung

1) Bescheinigungs-Nummer

1. Der Bescheinigungsinhaber hat die Voraussetzungen einzuhalten, die bei der Herstellung des umseitig genannten Produktes zu beachten sind, um die Übereinstimmung mit dem geprüften Baumuster zu gewährleisten.
2. Die Prüf- und Zertifizierungsstelle des Fachbereichs Nahrungsmittel führt in regelmäßigen Abständen Kontrollmaßnahmen zur Überwachung der Herstellung und rechtmäßigen Verwendung des GS-Zeichens durch.
3. Die für die Herstellung verantwortliche Person hat sich zur Einhaltung der Voraussetzungen nach Nummer 1 und Duldung der Kontrollmaßnahmen verpflichtet.
4. Die Prüf- und Zertifizierungsstelle entzieht dem Bescheinigungsinhaber die Zuerkennung des GS-Zeichens, wenn sich die Anforderungen nach § 21 Absatz 1 Produktsicherheitsgesetz geändert haben oder die Voraussetzungen nach Nummer 1 nicht eingehalten werden.
5. Das GS-Zeichen darf nur verwendet und mit ihm darf nur geworben werden, wenn die Voraussetzungen nach § 22 Produktsicherheitsgesetz erfüllt sind.

## 21. Product registration

# Online Product Registration

Register your BINDER now!

[www.binder-world.com/register](http://www.binder-world.com/register)

The registration is free and takes just a few seconds

Advantages:

- ▶ Short response times if service is needed
- ▶ Fair prices when relocating or installing equipment
- ▶ Calibration as required at no charge in case of recalls
- ▶ Free information on news, product upgrades and accessories

Easy registered in 3 steps:



1. List serial number here:

  -     

2. Go online: [www.binder-world.com/register](http://www.binder-world.com/register)

3. Register serial number

## 22. Contamination clearance certificate

### 22.1 For units located outside North America and Central America

#### Declaration with regard to safety and health

Erklärung zur Sicherheit und gesundheitlichen Unbedenklichkeit

The German Ordinance on Hazardous Substances (GefStofV), and the regulations regarding safety at the workplace, require that this form be filled out for all products that are returned to us, so that the safety and health of our employees can be warranted

Die Sicherheit und Gesundheit unserer Mitarbeiter, die Gefahrstoffverordnung GefStofV und die Vorschriften zur Sicherheit am Arbeitsplatz machen es erforderlich, dass dieses Formblatt für alle Produkte, die an uns zurückgeschickt werden, ausgefüllt wird.



In the absence of a completely filled out form, a repair is not possible.  
Ohne Vorliegen des vollständig ausgefüllten Formblattes ist eine Reparatur nicht möglich.

- A completely filled out form should be transmitted by Fax (+49 (0) 7462 2005 93555) or by letter in advance to us, so that this information is available before the equipment/component part arrives. A second copy of this form should accompany the equipment/component part. Eventually the carrier should be informed.

Eine vollständig ausgefüllte Kopie dieses Formblattes soll per Fax unter Nr. +49 (0) 7462 2005 93555 oder Brief vorab an uns gesandt werden, so dass die Information vorliegt, bevor das Gerät/Bauteil eintrifft. Eine weitere Kopie soll dem Gerät/Bauteil beigelegt sein. Ggf. ist die Spedition zu informieren.

- Incomplete information or non-conformity with this procedure will inevitably lead to substantial delays in processing. We hope you will have understanding for this measure, which lies outside of our area of influence, and that you will help us to speed up this procedure.

Unvollständige Angaben oder Nichteinhalten dieses Ablaufs führen zwangsläufig zu beträchtlichen Verzögerungen in der Abwicklung. Bitte haben Sie Verständnis für Maßnahmen, die außerhalb unserer Einflussmöglichkeiten liegen und helfen Sie mit, den Ablauf zu beschleunigen.

- **Please fill out this form completely**

Bitte unbedingt vollständig ausfüllen!

<b>1.</b>	<b>Unit/ component part / type</b> / Gerät / Bauteil / Typ:
<b>2.</b>	<b>Serial No.</b> / Serien-Nr.:
<b>3.</b>	<b>Details about utilized substances / biological substances</b> / Einzelheiten über die eingesetzten Substanzen/biologische Materialien:
<b>3.1</b>	<b>Designations</b> / Bezeichnungen:
a)	_____
b)	_____
c)	_____
<b>3.2</b>	<b>Safety measures required for handling these substances</b> / Vorsichtsmaßnahmen beim Umgang mit diesen Stoffen:
a)	_____
b)	_____
c)	_____

<b>3.3 Measures to be taken in case of skin contact or release into the atmosphere / Maßnahmen bei Personenkontakt oder Freisetzung:</b> a) _____ b) _____ c) _____ d) _____
<b>3.4 Other important information that must be taken into account / Weitere zu beachtende und wichtige Informationen:</b> a) _____ b) _____ c) _____
<b>4. Declaration on the risk of these substances (please checkmark the applicable items) / Erklärung zur Gefährlichkeit der Stoffe (bitte Zutreffendes ankreuzen) :</b>
<input type="checkbox"/> <b>4.1 For non toxic, non radioactive, biologically harmless materials / für nicht giftige, nicht radioaktive, biologisch ungefährliche Stoffe:</b> <b>We herewith guarantee that the above-mentioned unit / component part... / Wir versichern, dass o.g. Gerät/Bauteil...</b> <input type="checkbox"/> Has not been exposed to or contains any toxic or otherwise hazardous substances / weder giftige noch sonstige gefährliche Stoffe enthält oder solche anhaften. <input type="checkbox"/> That eventually generated reaction products are non-toxic and also do not represent a hazard / auch evtl. entstandene Reaktionsprodukte weder giftig sind noch sonst eine Gefährdung darstellen. <input type="checkbox"/> Eventual residues of hazardous substances have been removed / evtl. Rückstände von Gefahrstoffen entfernt wurden.
<input type="checkbox"/> <b>4.2 For toxic, radioactive, biologically harmful or hazardous substances, or any other hazardous materials / für giftige, radioaktive, biologisch bedenkliche bzw. gefährliche Stoffe oder anderweitig gefährliche Stoffe.</b> <b>We herewith guarantee that ... / Wir versichern, dass ...</b> <input type="checkbox"/> The hazardous substances, which have come into contact with the above-mentioned equipment / component part, have been completely listed under item 3.1 and that all information in this regard is complete / die gefährlichen Stoffe, die mit dem o.g. Gerät/Bauteil in Kontakt kamen, in 3.1 aufgelistet sind und alle Angaben vollständig sind. <input type="checkbox"/> That the unit /component part has not been in contact with radioactivity / das Gerät/Bauteil nicht mit Radioaktivität in Berührung kam
<b>5. Kind of transport / transporter / Transportweg/Spediteur:</b>  Transport by (means and name of transport company, etc.) Versendung durch (Name Spediteur o.ä.) _____  Date of dispatch to BINDER GmbH / Tag der Absendung an BINDER GmbH: _____

**We herewith declare that the following measures have been taken / Wir erklären, dass folgende Maßnahmen getroffen wurden:**

- Hazardous substances were removed from the unit / component part, so that no hazard exists for corresponding persons in the handling or repair of these items / das Gerät/Bauteil wurde von Gefahrstoffen befreit, so dass bei Handhabung/Reparaturen für die betreffenden Person keinerlei Gefährdung besteht
- The unit was securely packaged and properly identified / das Gerät wurde sicher verpackt und vollständig gekennzeichnet.
- Information about the hazardousness of the shipment (if required) has been provided to the transporter / der Spediteur wurde (falls vorgeschrieben) über die Gefährlichkeit der Sendung informiert.

We herewith commit ourselves and guarantee that we will indemnify BINDER GmbH for all damages that are a consequence of incomplete or incorrect information provided by us, and that we will exempt BINDER GmbH from eventual damage claims by third parties./ Wir versichern, dass wir gegenüber BINDER für jeden Schaden, der durch unvollständige und unrichtige Angaben entsteht, haften und BINDER gegen eventuell entstehende Schadenansprüche Dritter freistellen.

We are aware that, in accordance with Article 823 of the German Civil Code (BGB), we are directly liable with regard to third parties, in this instance especially the employees of BINDER GmbH, who have been entrusted with the handling / repair of the unit / component. / Es ist uns bekannt, dass wir gegenüber Dritten – hier insbesondere mit der Handhabung/Reparatur des Geräts/des Bauteils betraute Mitarbeiter der Firma BINDER – gemäß §823 BGB direkt haften

Name: \_\_\_\_\_

Position: \_\_\_\_\_

Date / Datum: \_\_\_\_\_

Signature / Unterschrift: \_\_\_\_\_

Company stamp / Firmenstempel:



Equipment that is returned to the factory for repair must be accompanied by a completely filled out contamination clearance certificate. For service and maintenance works on site, such a contamination clearance certificate must be submitted to the service technician before the start of the works. No repair or maintenance of the equipment is possible, without a properly filled out contamination clearance certificate.

## 22.2 For units in North America and Central America

### Product Return Authorization Request

Please complete this form and the Customer Decontamination Declaration (next 2 pages) and attach the required pictures. E-mail to: IDL\_SalesOrderProcessing\_USA@binder-world.com

After we have received and reviewed the complete information we will decide on the issue of a RMA number. Please be aware that size specifications, voltage specifications as well as performance specifications are available on the internet at [www.binder-world.us](http://www.binder-world.us) at any time.

Take notice of shipping laws and regulations.

	Please fill:	
Reason for return request	<input type="radio"/> Duplicate order	
	<input type="radio"/> Duplicate shipment	
	<input type="radio"/> Demo	<i>Page one completed by sales</i>
	<input type="radio"/> Power Plug / Voltage	115V / 230 V / 208 V / 240V
	<input type="radio"/> Size does not fit space	
	<input type="radio"/> Transport Damage	Shock watch tripped? ( <i>pictures</i> )
	<input type="radio"/> Other (specify below)	
	_____	
Is there a replacement PO?	<input type="radio"/> Yes <input type="radio"/> No	
<i>If yes -&gt; PO #</i>		
<i>If yes -&gt; Date PO placed</i>		
Purchase order number		
BINDER model number		
BINDER serial number		
Date unit was received		
Was the unit unboxed?	<input type="radio"/> Yes <input type="radio"/> No	
Was the unit plugged in?	<input type="radio"/> Yes <input type="radio"/> No	
Was the unit in operation?	<input type="radio"/> Yes <input type="radio"/> No	
<i>Pictures of unit attached?</i>	<input type="radio"/> Yes <input type="radio"/> No	Pictures have to be attached!
<i>Pictures of Packaging attached?</i>	<input type="radio"/> Yes <input type="radio"/> No	

	Customer Contact Information	Distributor Contact Information
Name		
Company		
Address		
Phone		
E-mail		

## Customer (End User) Decontamination Declaration

### Health and Hazard Safety declaration

To protect the health of our employees and the safety at the workplace, we require that this form is completed by the user for all products and parts that are returned to us. (Distributors or Service Organizations cannot sign this form)

	<p>NO RMA number will be issued without a completed form. Products or parts returned to our NY warehouse without a RMA number will be refused at the dock.</p>
---	--

A second copy of the completed form must be attached to the outside of the shipping box.

<b>1.</b>	<b>Unit/ component part / type:</b>
<b>2.</b>	<b>Serial No.</b>
<b>3.</b>	<b>List any exposure to hazardous liquids, gasses or substances and radioactive material</b>
<b>3.1</b>	<b>List with MSDS sheets attached where available or needed (if there is not enough space available below, please attach a page):</b>
a)	_____
b)	_____
c)	_____
<b>3.2</b>	<b>Safety measures required for handling the list under 3.1</b>
a)	_____
b)	_____
c)	_____
<b>3.3</b>	<b>Measures to be taken in case of skin contact or release into the atmosphere:</b>
a)	_____
b)	_____
c)	_____
d)	_____
<b>3.4</b>	<b>Other important information that must be considered:</b>
a)	_____
b)	_____
c)	_____

**4. Declaration of Decontamination**

**For toxic, radioactive, biologically and chemically harmful or hazardous substances, or any other hazardous materials.**

**We hereby guarantee that**

- 4.1 Any hazardous substances, which have come into contact with the above-mentioned equipment / component part, have been completely listed under item 3.1 and that all information in this regard is complete.
- 4.2 That the unit /component part has not been in contact with radioactivity
- 4.3 Any Hazardous substances were removed from the unit / component part, so that no hazard exists for a persons in the shipping, handling or repair of these returned unit
- 4.4 The unit was securely packaged in the original undamaged packaging and properly identified on the outside of the packaging material with the unit designation, the RMA number and a copy of this declaration.
- 4.5 Shipping laws and regulations have not been violated.

**I hereby commit and guarantee that we will indemnify BINDER Inc. for all damages that are a consequence of incomplete or incorrect information provided by us, and that we will indemnify and hold harmless BINDER Inc. from eventual damage claims by third parties.**

Name: \_\_\_\_\_

Position: \_\_\_\_\_

Company: \_\_\_\_\_

Address: \_\_\_\_\_

Phone #: \_\_\_\_\_

Email: \_\_\_\_\_

Date: \_\_\_\_\_

Signature: \_\_\_\_\_



Equipment returned to the NY warehouse for repair must be accompanied by a completed customer decontamination declaration. For service and maintenance works on site, such a customer decontamination declaration must be submitted to the service technician before the start of work. No repair or maintenance of the equipment is possible without a completed form.



