

Operating Manual

Translation of the original operating manual

KBW (E6)

Growth chambers with light

with program control and adjustable light cassettes

Model	Model version	Art. No.
KBW 240	KBW240-230V	9020-0338, 9120-0338
KBW 400	KBW400-230V	9020-0339, 9120-0339
KBW 720	KBW720-230V	9020-0340, 9120-0340

BINDER GmbH

- ▶ Address: Post office box 102, 78502 Tuttlingen, Germany ▶ Phone: +49 7462 2005 0
- ▶ Fax: +49 7462 2005 100 ▶ Internet: <http://www.binder-world.com>
- ▶ E-mail: info@binder-world.com ▶ Service Hotline: +49 7462 2005 555
- ▶ Service Fax: +49 7462 2005 93 555 ▶ Service E-Mail: customerservice@binder-world.com
- ▶ Service Hotline USA: +1 866 885 9794 or +1 631 224 4340 x3
- ▶ Service Hotline Asia Pacific: +852 390 705 04 or +852 390 705 03
- ▶ Service Hotline Russia and CIS: +7 495 988 15 16

Content

1. SAFETY	6
1.1 Personnel Qualification	6
1.2 Operating manual.....	6
1.3 Legal considerations	6
1.3.1 Intellectual property	7
1.4 Structure of the safety instructions.....	7
1.4.1 Signal word panel	7
1.4.2 Safety alert symbol	8
1.4.3 Pictograms.....	8
1.4.4 Word message panel structure	9
1.5 Localization / position of safety labels on the chamber	9
1.6 Type plate.....	9
1.7 General safety instructions on installing and operating the chambers	10
1.8 Intended use	12
1.9 Foreseeable Misuse	14
1.10 Residual Risks	14
1.11 Operating instructions	16
1.12 Measures to prevent accidents	16
2. CHAMBER DESCRIPTION AND OVERVIEW	17
2.1 Chamber description	17
2.2 Chamber overview	18
2.3 Instrument panel	18
2.4 Lateral control panels.....	19
3. COMPLETENESS OF DELIVERY, TRANSPORTATION, STORAGE, AND INSTALLATION	20
3.1 Unpacking, and checking equipment and completeness of delivery	20
3.2 Guidelines for safe lifting and transportation.....	21
3.3 Storage.....	21
3.4 Location of installation and ambient conditions	21
4. INSTALLATION AND CONNECTIONS	23
4.1 Spacer for wall distance	23
4.2 Mounting the flexible tilt protection kit (KBW 400)	24
4.3 Installation and connection of the light cassettes	25
4.4 Electrical connection	26
5. FUNCTIONAL OVERVIEW OF THE MB2 CHAMBER CONTROLLER	27
5.1 Operating functions in normal display	28
5.2 Display views: Normal display, program display, chart-recorder display.....	29
5.3 Controller icons overview	30
5.4 Operating modes.....	32
5.5 Controller menu structure.....	33
5.5.1 Main menu	34
5.5.2 “Settings” submenu	35
5.5.3 “Service” submenu	35
5.6 Principle of controller entries.....	36
5.7 Performance during and after power failures.....	36
5.8 Performance when opening the door	37
6. START UP	37
6.1 Turning on the chamber	37
6.2 Controller settings upon start up	37

7.	SET-POINT ENTRY IN “FIXED VALUE” OPERATING MODE	38
7.1	Set-point entry for temperature and fan speed through the “Setpoints” menu	39
7.2	Direct setpoint entry for temperature via Normal display	39
7.3	Automatic correction of the actual value when turning on or off the illumination	40
7.4	Light commutation and special controller functions via operation lines	40
8.	TIMER PROGRAM: STOPWATCH FUNCTION	41
8.1	Starting a timer program	41
8.1.1	Performance during program delay time	41
8.2	Stopping a running timer program	42
8.2.1	Pausing a running timer program	42
8.2.2	Cancelling a running timer program	42
8.3	Performance after the end of the program	42
9.	TIME PROGRAMS	43
9.1	Starting an existing time program	43
9.1.1	Performance during program delay time	44
9.2	Stopping a running time program	44
9.2.1	Pausing a running time program	44
9.2.2	Cancelling a running time program	44
9.3	Performance after the end of the program	44
9.4	Creating a new time program	45
9.5	Program editor: program management	45
9.5.1	Deleting a time program	46
9.6	Section editor: section management	47
9.6.1	Add a new program section	48
9.6.2	Copy and insert or replace a program section	48
9.6.3	Deleting a program section	49
9.7	Value entry for a program section	50
9.7.1	Section duration	50
9.7.2	Set-point ramp and set-point step	51
9.7.3	Light commutation and special controller functions via operation lines	52
9.7.4	Setpoint entry	53
9.7.5	Tolerance ranges	54
9.7.6	Repeating one or several sections within a time program	54
9.7.7	Saving the time program	55
10.	WEEK PROGRAMS	56
10.1	Starting an existing week program	56
10.2	Cancelling a running week program	56
10.3	Creating a new week program	57
10.4	Program editor: program management	58
10.4.1	Deleting a week program	59
10.5	Section editor: section management	60
10.5.1	Add a new program section	61
10.5.2	Copy and insert or replace a program section	61
10.5.3	Deleting a program section	62
10.6	Value entry for a program section	62
10.6.1	Set-point ramp and set-point step modes	62
10.6.2	Weekday	63
10.6.3	Start time	63
10.6.4	Setpoint entry	64
10.6.5	Light commutation and special controller functions via operation lines	64
11.	NOTIFICATION AND ALARM FUNCTIONS	65
11.1	Notification and alarm messages overview	65
11.1.1	Notifications	65
11.1.2	Alarm messages	66

11.2	State of alarm	66
11.3	Resetting an alarm, list of active alarms	67
11.4	Tolerance range settings.....	67
11.5	Activating / deactivating the audible alarm (alarm buzzer)	68
12.	TEMPERATURE SAFETY DEVICES	68
12.1	Over temperature protective device (class 1)	68
12.2	Overtemperature safety controller class 3.1	69
12.2.1	Safety controller modes.....	69
12.2.2	Setting the safety controller	70
12.2.3	Message and measures in the state of alarm	71
12.2.4	Function check	71
12.3	Temperature safety device class 3.3 (option).....	71
12.3.1	Temperature safety device class 3.1.....	72
12.3.2	Temperature safety device class 3.2.....	73
13.	USER MANAGEMENT	74
13.1	Authorization levels and password protection.....	74
13.2	Log in.....	77
13.3	Log out	78
13.4	User change.....	78
13.5	Password assignment and password change.....	79
13.5.1	Password change	79
13.5.2	Deleting the password for an individual authorization level	81
13.5.3	New password assignment for “service” or “admin” authorization level when the password function was deactivated	82
13.6	Activation code	83
14.	GENERAL CONTROLLER SETTINGS.....	84
14.1	Selecting the controller’s menu language	84
14.2	Setting date and time	84
14.3	Selecting the temperature unit	86
14.4	Display configuration.....	86
14.4.1	Adapting the display parameters.....	86
14.4.2	Touchscreen calibration	87
14.5	Network and communication.....	88
14.5.1	Serial interfaces.....	88
14.5.2	Ethernet.....	89
14.5.3	Web server	90
14.5.4	E-Mail.....	91
14.6	USB menu: Data transfer via USB interface	92
15.	GENERAL INFORMATION	93
15.1	Service contact page.....	93
15.2	Current operating parameters	93
15.3	Event list.....	94
15.4	Technical chamber information	94
15.5	Self-test function	95
16.	CHART RECORDER DISPLAY	97
16.1	Views.....	97
16.1.1	Show and hide legend	97
16.1.2	Switch between legend pages.....	97
16.1.3	Show and hide specific indications.....	98
16.1.4	History display	98
16.2	Setting the parameters.....	101
17.	DEFROSTING AT REFRIGERATING OPERATION	102

18. ILLUMINATION SYSTEM	103
18.1 Illumination for optimal plant growth	103
18.2 Adjustable light cassettes.....	103
18.3 Illumination control	105
19. OPTIONS.....	106
19.1 APT-COM™ 4 Multi Management Software (option).....	106
19.2 RS485 interface (option)	106
19.3 Data logger kit (option).....	106
19.4 Analog outputs for temperature (option)	106
19.5 Zero-voltage relay alarm outputs for temperature-(option)	107
19.6 Object temperature display with flexible Pt 100 temperature sensor (option)	108
20. CLEANING AND DECONTAMINATION	109
20.1 Cleaning	109
20.2 Decontamination / chemical disinfection.....	111
21. MAINTENANCE AND SERVICE, TROUBLESHOOTING, REPAIR, TESTING.	112
21.1 General information, personnel qualification.....	112
21.2 Maintenance intervals, service.....	112
21.3 Replacement of the fluorescent tubes	113
21.4 Simple troubleshooting.....	114
21.5 Sending the chamber back to BINDER GmbH	117
22. DISPOSAL.....	117
22.1 Disposal of the transport packing.....	117
22.2 Decommissioning	118
22.3 Disposal of the chamber in the Federal Republic of Germany	118
22.4 Disposal of the chamber in the member states of the EU except for the Federal Republic of Germany.....	119
22.5 Disposal of the chamber in non-member states of the EU	120
23. TECHNICAL DESCRIPTION.....	121
23.1 Factory calibration and adjustment	121
23.2 Over current protection	121
23.3 Definition of usable volume	121
23.4 Technical Data	122
23.5 Equipment and options (extract)	123
23.6 Accessories and spare parts (extract)	124
23.7 Dimensions KBW 240	126
23.8 Dimensions KBW 400	127
23.9 Dimensions KBW 720	128
24. CERTIFICATES AND DECLARATIONS OF CONFORMITY.....	129
24.1 EU Declaration of Conformity.....	129
24.2 Certificate for the GS mark of conformity of the “Deutsche Gesetzliche Unfallversicherung e.V.“ (German Social Accident Insurance) DGUV	132
25. CONTAMINATION CLEARANCE CERTIFICATE	134
25.1 For chambers located outside USA and Canada	134
25.2 For chambers located in USA and Canada	137

Dear customer,

For the correct operation of the chambers, it is important that you read this operating manual completely and carefully and observe all instructions as indicated. Failure to read, understand and follow the instructions may result in personal injury. It can also lead to damage to the chamber and/or poor equipment performance.

1. Safety

1.1 Personnel Qualification



The chamber must only be installed, tested, and started up by personnel qualified for assembly, startup, and operation of the chamber. Qualified personnel are persons whose professional education, knowledge, experience and knowledge of relevant standards allow them to assess, carry out, and identify any potential hazards in the work assigned to them. They must have been trained and instructed, and be authorized, to work on the chamber.

The chamber should only be operated by laboratory personnel especially trained for this purpose and familiar with all precautionary measures required for working in a laboratory. Observe the national regulations on minimum age of laboratory personnel.

1.2 Operating manual

This operating manual is part of the components of delivery. Always keep it handy for reference in the vicinity of the chamber. If selling the unit, hand over the operating manual to the purchaser.

To avoid injuries and damage observe the safety instructions of the operating manual. Failure to follow instructions and safety precautions can lead to significant risks.

	 DANGER
	<p>Dangers due to failure to observe the instructions and safety precautions. Serious injuries and chamber damage. Risk of death.</p> <ul style="list-style-type: none"> ➤ Observe the safety instructions in this Operating Manual. ➤ Follow the operating procedures in this Operating Manual. ➤ Carefully read the complete operating instructions of the chamber prior to installing and using the chamber. ➤ Keep the operating manual for future reference

	<p>Make sure that all persons who use the chamber and its associated work equipment have read and understood the Operating Manual.</p>
---	--

This Operating Manual is supplemented and updated as needed. Always use the most recent version of the Operating Manual. When in doubt, call the BINDER Service Hotline for information on the up-to-date-ness and validity of this Operating Manual.

1.3 Legal considerations

This operating manual is for informational purposes only. It contains information for correct and safe installing, start-up, operation, decommissioning, cleaning and maintenance of the product. Note: the contents and the product described are subject to change without notice.

Understanding and observing the instructions in this operating manual are prerequisites for hazard-free use and safety during operation and maintenance. Images are to provide basic understanding. They may deviate from the actual version of the chamber. The actual scope of delivery can, due to optional or special design, or due to recent technical changes, deviate from the information and illustrations in these instructions this operating manual. In no event shall BINDER be held liable for any damages, direct or incidental arising out of or related to the use of this manual.

This operating manual cannot cover all conceivable applications. If you would like additional information, or if special problems arise that are not sufficiently addressed in this manual, please ask your dealer or contact us directly, e.g. by phone at the number located on page one of this manual

Furthermore, we emphasize that the contents of this operating manual are not part of an earlier or existing agreement, description, or legal relationship, nor do they modify such a relationship. All obligations on the part of BINDER derive from the respective purchase contract, which also contains the entire and exclusively valid statement of warranty administration and the general terms and conditions, as well as the legal regulations valid at the time the contract is concluded. The statements in this manual neither augment nor restrict the contractual warranty provisions.

1.3.1 Intellectual property

Trademark Information: All BINDER trademarks relating to products or service, as well as trade names, logos and product names used on the website, products and documents of BINDER company are trademarks or registered trademarks of BINDER company (including BINDER GmbH, BINDER Inc.) in the U.S. and other countries and communities of states. This includes word marks, position marks, word/figurative marks, design configurations, figurative marks, and design patents.

Patent Information: BINDER products, categories of products, and accessories may be covered by one or more patents and/or utility models in the U.S. and other countries and communities of states. Additional patent applications may also be pending in the U.S. and other countries and communities of states.

Please visit www.binder-world.com for more information.

1.4 Structure of the safety instructions

In this operating manual, the following safety definitions and symbols indicate dangerous situations following the harmonization of ISO 3864-2 and ANSI Z535.6.

1.4.1 Signal word panel

Depending on the probability of serious consequences, potential dangers are identified with a signal word, the corresponding safety color, and if appropriate, the safety alert symbol.

 DANGER
Indicates an imminently hazardous situation that, if not avoided, will result in death or serious (irreversible) injury.

 WARNING
Indicates a potentially hazardous situation which, if not avoided, could result in death or serious (irreversible) injury.

 CAUTION
Indicates a potentially hazardous situation which, if not avoided, may result in moderate or minor (reversible) injury.

NOTICE

Indicates a potentially hazardous situation which, if not avoided, may result in damage to the product and/or its functions or of a property in its proximity.



















1.4.2 Safety alert symbol



Use of the safety alert symbol indicates a **risk of injury**.

Observe all measures that are marked with the safety alert symbol in order to avoid death or injury.

1.4.3 Pictograms

Warning signs			
			
Electrical hazard	Hot surface	Explosive atmosphere	Stability hazard
			
Lifting hazard	Risk of corrosion and / or chemical burns	Harmful substances	Biohazard
			
Pollution Hazard			
Mandatory action signs			
			
Mandatory regulation	Read operating instructions	Disconnect the power plug	Lift with mechanical assistance
			
Environment protection	Wear protective gloves	Wear safety goggles	
Prohibition signs			
			
Do NOT touch	Do NOT spray with water	Do NOT climb	



Information to be observed in order to ensure optimum function of the product.

1.4.4 Word message panel structure

Type / cause of hazard.

Possible consequences.

- ⊘ Instruction how to avoid the hazard: prohibition
- Instruction how to avoid the hazard: mandatory action.

Observe all other notes and information not necessarily emphasized in the same way, in order to avoid disruptions that could result in direct or indirect injury or property damage.

1.5 Localization / position of safety labels on the chamber

The following labels are located on the chamber:

Pictograms (warning signs)



Hot surface (inner glass door above the glass door handle)

Service label

Service - Hotline

International: + 49 (0) 7462 / 2005-555

USA Toll Free: + 1 866 885 9794

or: + 1 631 224 4340

Россия и СНГ: + 7 495 98815 17

service@binder-world.com
www.binder-world.com



Keep safety labels complete and legible.

Replace safety labels that are no longer legible. Contact BINDER Service for these replacements.

1.6 Type plate

The type plate sticks to the left side of the chamber, bottom right-hand.





Nominal temp.	70 °C 158 °F	1,40 kW / 6,1 A 200-230 V / 50 Hz		 	Max. operating pressure 15 bar R 134A – 0,27 kg
IP protection	20		 		Contains fluorinated greenhouse gases covered by the Kyoto Protocol
Safety device	DIN 12880	1 N ~			
Class	3.1				
Art. No.	9020-0338				
Project No.		Growth chamber			
Built	2021				
	BINDER GmbH Im Mittleren Ösch 5 78532 Tuttlingen / Germany www.binder-world.com	KBW 240 E6	Serial No. 00000000000000 Made in Germany		

Figure 1: Type plate (example KBW 240 regular chamber)

Indications of the type plate (example)

Indication		Information
BINDER		Manufacturer: BINDER GmbH
KBW 240		Model designation
Growth chamber		Device name
Built	2020	Serial no. of the chamber
Serial No.	00000000000000	Year of construction
Nominal temperature	70 °C / 158 °F	Nominal temperature
IP protection	21	IP type of protection acc. to standard EN 60529
Temp. safety device	DIN 12880	Temperature safety device acc. to standard DIN 12880:2007
Class	3.1	Class of temperature safety device
Art. No.	9020-0338	Art. no. of the chamber
Project No.	---	Optional: Special application acc. to project no.
1,40 kW		Nominal power
6,1 A		Nominal current
200-230 V / 50 Hz		Nominal voltage range +/-10% at the indicated power frequency
1 N ~		Current type
Max. operating pressure 15 bar		Max operating pressure in the refrigerating system (15 bar / 218 PSI)
R 134A - 0,27 kg		Refrigerant type and filling weight
Contains fluorinated greenhouse gases covered by the Kyoto Protocol		

Symbols on the type plate

Symbol	Information
	CE conformity marking
	Electrical and electronic equipment manufactured / placed on the market in the EU after 13 August 2005 and be disposed of in separate collection according to Directive 2012/19/EU on waste electrical and electronic equipment (WEEE).
	GS mark of conformity of the "Deutsche Gesetzliche Unfallversicherung e.V. (DGUV), Prüf- und Zertifizierungsstelle Nahrungsmittel und Verpackung im DGUV Test" (German Social Accident Insurance (DGUV), Testing and Certification Body for Foodstuffs and Packaging Industry in DGUV Test).
	The chamber is certified according to Customs Union Technical Regulation (CU TR) for the Eurasian Economic Union (Russia, Belarus, Armenia, Kazakhstan Kyrgyzstan).

1.7 General safety instructions on installing and operating the chambers



With regard to operating the chambers and to the installation location, please observe the local and national regulations relevant for your country (for Germany: DGUV guidelines 213-850 on safe working in laboratories, issued by the employers' liability insurance association).

BINDER GmbH is only responsible for the safety features of the chamber provided skilled electricians or qualified personnel authorized by BINDER perform all maintenance and repair, and if components relating to chamber safety are replaced in the event of failure with original spare parts.



To operate the chamber, use only original BINDER accessories or accessories from third-party suppliers authorized by BINDER. The user is responsible for any risk caused by using unauthorized accessories.

	NOTICE
	<p>Danger of overheating due to lack of ventilation.</p> <p>Damage to the chamber.</p> <ul style="list-style-type: none"> ∅ Do NOT install the chamber in unventilated recesses. ➤ Ensure sufficient ventilation for dispersal of the heat. ➤ Observe the prescribed minimum distances when installing the chamber (chap. 3.4)

Do not install or operate the chamber in hazardous locations.



	 DANGER
	<p>Danger of explosion due to combustible dusts or explosive mixtures in the vicinity of the chamber.</p> <p>Serious injury or death from burns and / or explosion pressure.</p> <ul style="list-style-type: none"> ∅ Do NOT operate the chamber in potentially explosive areas. ➤ KEEP combustible dust or air-solvent mixtures AWAY from the chamber.

The chamber does not dispose of any measures of explosion protection.

	 DANGER
	<p>Danger of explosion due to introduction of flammable or explosive substances in the chamber.</p> <p>Serious injury or death from burns and / or explosion pressure.</p> <ul style="list-style-type: none"> ∅ Do NOT introduce any substance into the chamber which is combustible or explosive at working temperature. ∅ Do NOT introduce any combustible dust or air-solvent mixture in the inner chamber.



Any solvent contained in the charging material must not be explosive or inflammable. I.e., irrespective of the solvent concentration in the steam room, NO explosive mixture with air must form. The temperature inside the chamber must lie below the flash point or below the sublimation point of the charging material. Familiarize yourself with the physical and chemical properties of the charging material, as well as the contained moisture constituent and its behavior with the addition of heat energy.



Familiarize yourself with any potential health risks caused by the charging material, the contained moisture constituent or by reaction products that may arise during the temperature process. Take adequate measures to exclude such risks prior to putting the chamber into operation.

	 DANGER
	<p>Electrical hazard by water entering the chamber.</p> <p>Deadly electric shock.</p> <ul style="list-style-type: none"> ∅ The chamber must NOT become wet during operation, cleaning, or maintenance. ∅ Do NOT install the chamber in damp areas or in puddles. ➤ Set up the chamber in a way that it is splash-proof.

The chambers were produced in accordance with VDE regulations and were routinely tested in accordance to VDE 0411-1 (IEC 61010-1).

During and shortly after operation, the temperature of the inner surfaces almost equals the set-point. The glass doors, the glass door handles, the light cassettes, and the inner chamber will become hot during operation.

	 CAUTION
	<p>Danger of burning by touching hot chamber parts during operation.</p> <p>Burns.</p> <p>∅ Do NOT touch the inner surfaces, the glass doors, the light cassettes, or the loading material during operation.</p>

 	 WARNING
	<p>Danger of injury and damages by the chamber tipping over or breakaway of the protruding lower housing cover.</p> <p>Injuries and damage to the chamber and the loading material</p> <p>∅ Do NOT load the lower housing cover with heavy objects while the chamber door is open and do NOT climb on it.</p>

1.8 Intended use

	<p>Following the instructions in this operating manual and conducting regular maintenance work (chap. 20) are part of the intended use.</p>
---	---

Any use of the chambers that does not comply with the requirements specified in this Operating Manual shall be considered improper use.

Other applications than those described in this chapter are not approved.

Use



Growth chambers with light KBW are suitable for exact simulation of growth conditions and conditioning of harmless materials. Because of their precise temperature accuracy these devices are especially useful for incubation of cultures at a standard temperature of 37 °C.

Requirements for the chamber load



Any solvent must not be explosive and flammable. A mixture of any component of the charging material with air must NOT be explosive. The operating temperature must lie below the flash point or below the sublimation point of the charging material. Any component of the charging material must NOT be able to release toxic gases.

The loading material shall not contain any corrosive ingredients that may damage the machine components made of stainless steel, aluminum, and copper. Such ingredients include in particular acids and halides. Any corrosive damage caused by such ingredients is excluded from liability by BINDER GmbH.

The chamber does not dispose of any measures of explosion protection.

 	 DANGER
	<p>Explosion or implosion hazard and danger of poisoning through the introduction of unsuitable loading material.</p> <p>Poisoning. Serious injury or death from burns and / or explosion pressure.</p> <ul style="list-style-type: none"> ⊘ Do NOT introduce any substance combustible or explosive at working temperature into the chamber, in particular no energy sources such as batteries or lithium-ion batteries. ⊘ NO explosive dust or air-solvent mixture in the inner chamber. ⊘ Do NOT introduce any substance which could lead to release of toxic gases.

Contamination of the chamber by toxic, infectious or radioactive substances must be prevented

 	 WARNING
	<p>Danger of intoxication and infection through contamination of the chamber with toxic, infectious or radioactive substances.</p> <p>Damages to health.</p> <ul style="list-style-type: none"> ➤ Protect the interior of the chamber from contamination by toxic, infectious or radioactive substances. ➤ Take suitable protective measures when introducing and removing toxic, infectious or radioactive material

In case of foreseeable use of the chamber there is no risk for the user through the integration of the chamber into systems or by special environmental or operating conditions in the sense of EN 61010-1:2010. For this, the intended use of the chamber and all its connections must be observed.

Medical devices

The chambers are not classified as medical devices as defined by the Medical Device Directive 93/42/EEC and Regulation (EU) No 2017/745.

	<p>Due to the special demands of the Medical Device Directive (MDD), these chambers are not qualified to perform sterilization of medical devices as defined by the directive 93/42/EWG.</p>
---	--

Personnel Requirements

Only trained personnel with knowledge of the Operating Manual can set up and install the chamber, start it up, operate, clean, and take it out of operation. Service and repairs call for further technical requirements (e.g. electrical know-how), as well as knowledge of the service manual.

Installation site requirements

The chambers are designed for setting up inside a building (indoor use).

The requirements described in the Operating Manual for installation site and ambient conditions (Chap. 3.4) must be met.

	<p>WARNING: If customer should use a BINDER chamber running in non-supervised continuous operation, we strongly recommend in case of inclusion of irrecoverable specimen or samples to split such specimen or samples and store them in at least two chambers, if this is feasible.</p>
---	--

1.9 Foreseeable Misuse

Other applications than those described in chap. 1.8 are not approved.

This expressly includes the following misuses (the list is not exhaustive), which pose risks despite the inherently safe construction and existing technical safety equipment:

- Non-observance of Operating Manual
- Non-observance of information and warnings on the chamber (e.g. control unit messages, safety identifiers, warning signals)
- Installation, startup, operation, maintenance and repair by untrained, insufficiently qualified, or unauthorized personnel
- Missed or delayed maintenance and testing
- Non-observance of traces of wear and tear
- Insertion of materials excluded or not permitted by this Operating Manual.
- Non-compliance with the admissible parameters for processing the respective material.
- Installation, testing, service or repair in the presence of solvents
- Installation of replacement parts and use of accessories and operating resources not specified and authorized by the manufacturer
- Installation, startup, operation, maintenance or repair of the chamber in absence of operating instructions
- Bypassing or changing protective systems, operation of the chamber without the designated protective systems
- Non-observance of messages regarding cleaning and disinfection of the chamber.
- Spilling water or cleaning agent on the chamber, water penetrating into the chamber during operation, cleaning or maintenance.
- Cleaning activity while the chamber is turned on.
- Operation of the chamber with a damaged housing or damaged power cord
- Continued operation of the chamber during an obvious malfunction
- Insertion of objects, particularly metallic objects, in louvers or other openings or slots on the chamber
- Human error (e.g. insufficient experience, qualification, stress, exhaustion, laziness)

To prevent these and other risks from incorrect operation, the operator shall issue operating instructions. Standard operating procedures (SOPs) are recommended.

1.10 Residual Risks

The unavoidable design features of a chamber, as well as its proper field of application, can also pose risks, even during correct operation. These residual risks include hazards which, despite the inherently safe design, existing technical protective equipment, safety precautions and supplementary protective measures, cannot be ruled out.

Messages on the chamber and in the Operating Manual warn of residual risks. The consequences of these residual risks and the measures required to prevent them are listed in the Operating Manual. Moreover, the operator must take measures to minimize hazards from unavoidable residual risks. This includes, in particular, issuing operating instructions.

The following list summarizes the hazards against which this Operating Manual and the Service Manual warn, and specifies protective measures at the appropriate spots:

Unpacking, Transport, Installation

- Sliding or tilting the chamber
- Setup of the chamber in unauthorized areas
- Installation of a damaged chamber
- Installation of a chamber with damaged power cord
- Inappropriate site of installation
- Missing protective conductor connection

Normal operation

- Assembly errors
- Contact with hot surfaces on the housing
- Contact with hot surfaces in the interior and inside of doors
- Emission of non-ionizing radiation from electrical operating resources
- Contact with live parts in normal state

Cleaning and Decontamination

- Penetration of water into the chamber
- Inappropriate cleaning and decontamination agents
- Enclosure of persons in the interior

Malfunction and Damage

- Continued operation of the chamber during an obvious malfunction or outage of the heating or cooling system
- Contact with live parts during error status
- Operation of a unit with damaged power cord

Maintenance

- Maintenance work on live parts.
- Execution of maintenance work by untrained/insufficiently qualified personnel
- Electrical safety analysis during annual maintenance not performed

Trouble-shooting and Repairs

- Non-observance of warning messages in the Service Manual
- Trouble-shooting of live parts without specified safety measures
- Absence of a plausibility check to rule out erroneous inscription of electrical components
- Performance of repair work by untrained/insufficiently qualified personnel
- Inappropriate repairs which do not meet the quality standard specified by BINDER
- Use of replacement parts other than BINDER original replacement parts
- Electrical safety analysis not performed after repairs

1.11 Operating instructions

Depending on the application and location of the chamber, the operator of the chamber must provide the relevant information for safe operation of the chamber in a set of operating instructions.



Keep these operating instructions with the chamber at all times in a place where they are clearly visible. They must be comprehensible and written in the language of the employees.

1.12 Measures to prevent accidents

The operator of the chamber must observe the local and national regulations (for Germany: the rule “Operation of work equipment. Operation of refrigeration systems, heat pumps and refrigeration equipment”, GUV-R 500 chap. 2.35) and take precautions to prevent accidents.

The manufacturer took the following measures to prevent ignition and explosions:

- **Indications on the type plate**

See operating manual chap. 1.6.

- **Operating manual**

An operating manual is available for each chamber.

- **Overtemperature monitoring**

The chamber is equipped with a temperature display, which can be read from outside.

The chamber is equipped with an additional safety controller (temperature safety device class 3.1 acc. to DIN 12880:2007). Visual and audible (buzzer) signals indicate temperature exceeding.

- **Safety, measurement, and control equipment**

The safety, measuring, and control equipment is easily accessible.

- **Electrostatic charge**

The interior parts are grounded.

- **Non-ionizing radiation**

Non-ionizing radiation is not intentionally produced, but released only for technical reasons by electrical equipment (e.g. electric motors, power cables, solenoids). The machine has no permanent magnets. If persons with active implants (e.g. pacemakers, defibrillators) keep a safe distance (distance of field source to implant) of 30 cm, an influence of these implants can be excluded with high probability.

- **Protection against touchable surfaces**

Tested according to EN ISO 13732-1:2008.

- **Floors**

See operating manual chap. 3.4 for correct installation

- **Cleaning**

See operating manual chap. 20.1.

- **Examinations**

The chamber has been inspected by the “Deutsche Gesetzliche Unfallversicherung e.V. (DGUV) (German Social Accident Insurance (DGUV))” (German Social Accident Insurance (DGUV), Testing and Certification Body for Foodstuffs and Packaging Industry in DGUV Test) and bears the GS mark.

2. Chamber description and overview

2.1 Chamber description

A high level of precision, reliability, and safety for all growth parameters ensures optimum incubation conditions. Moreover, the KBW growth chamber with light is designed for maximum usability – even in continuous operation year after year. It fulfills all technical and application-specific requirements arising in experimentation such as in the areas of biotechnology, medicine, the nutrition industry, pharmaceutical and cosmetics industries, botany, and zoology.

The chambers are equipped with a multifunctional microprocessor color display program controller for temperature, and illumination control. Temperature is displayed accurate to one-tenth of a degree. The KBW is a high-precision growth chamber for programmable light and temperature conditions. With its comprehensive program control functions, the MB2 display program controller permits the high precision performance of temperature cycles and illumination control.

Two important temperature technologies have been combined to achieve perfect temperature control. The specially developed DCT™ refrigerating system, a direct refrigerating process, in conjunction with the APT.line™ preheating chamber technology, satisfies the unique prerequisites for attaining highly-precise temperature control and particularly short recovery times after opening the door.

The refrigerating system is distinguished by direct, precise, and rapid temperature conduction. Large-area labyrinth evaporator plates directly conduct the cold to the atmosphere of the working space.

The horizontal air conduction of the APT.line™ preheating chamber technology, in conjunction with the controllable air turbine enables simulation of the natural air-flow conditions. The APT.line™ preheating chamber system guarantees high level of spatial and time-based temperature precision, thanks to the direct and distributed air circulation into the interior. This is especially important for maintaining temperatures – especially with full chambers – and for rapid restoration of optimum growth conditions after opening the door. The inner glass door ensures that the temperature remains constant when observing the incubation process. The fan supports exact attainment and maintenance of the desired temperature accuracy. The fan speed is digitally adjustable. The heating and refrigerating systems are microprocessor regulated to a tenth of a degree. In addition, the growth chamber with light provides almost unlimited possibilities for adaptation to individual customer requirements based upon extensive programming options of the controller.

The chamber is regularly equipped with daylight illumination tubes. It can be optionally equipped with plant growth lamps bearing the ideal spectrum for photosynthesis and thus become the ideal growing chamber for plants under programmable temperature conditions. The fluorescent tubes are built in light cassettes that can be freely positioned within wide areas. They illuminate very homogeneously the racks below them. The lamps can be switched in three groups. By adequately adjusting the program controller, an automatic day/night simulation can be performed.

Material: The inner chamber, the pre-heating chamber and the interior side of the doors are all made of stainless steel V2A (German material no. 1.4301, US equivalent AISI 304). The housing is RAL 7035 powder-coated. All corners and edges are completely coated.

All chamber functions are easy and comfortable to use thanks to their clear arrangement. Major features are easy cleaning of all chamber parts and avoidance of undesired contamination.

Controller: The efficient program controller is equipped with a multitude of operating functions, in addition to recorder and alarm functions. Programming of test cycles is easily accomplished via the modern MB2 touch screen controller and is also possible directly with a computer via Intranet in connection with the APT-COM™ 4 Multi Management Software (option, chap. 19.1). The chamber comes equipped with an Ethernet serial interface for computer communication. In addition, the BINDER APT-COM™ 4 Multi Management Software permits networking up to 100 chambers and connecting them to a PC for controlling and programming, as well as recording and representing temperature data. For further options, see chap.23.5.

The chambers are equipped with four castors. Both front castors can be easily locked via the attached brakes.

Temperature range at an ambient temperature of 22 °C +/- 3 °C / 71.6 °F +/- 5.4 °F:

- Without light cassettes: 0 °C / 32 °F up to +70 °C / 158 °F.
- With maximum illumination +5 °C / 41 °F up to +60 °C / 140 °F

2.2 Chamber overview

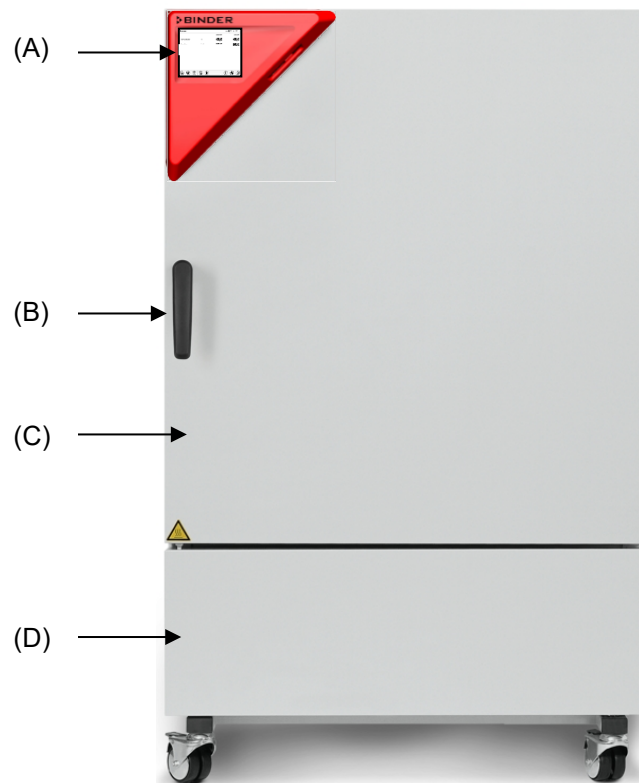

Figure 2: Growth chamber with light KBW 240

- (A) Instrument box
- (B) Door handle
- (C) Outer door
- (D) Refrigerating machine

2.3 Instrument panel

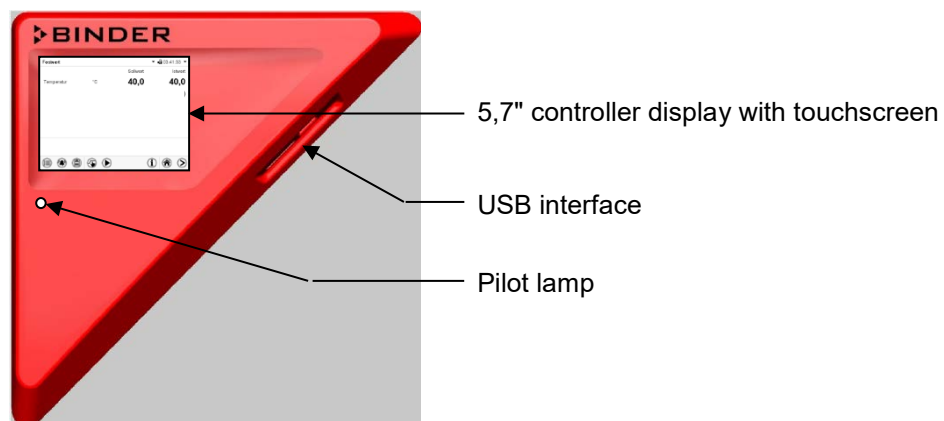

Figure 3: Instrument panel with MB2 program controller and USB interface

2.4 Lateral control panels

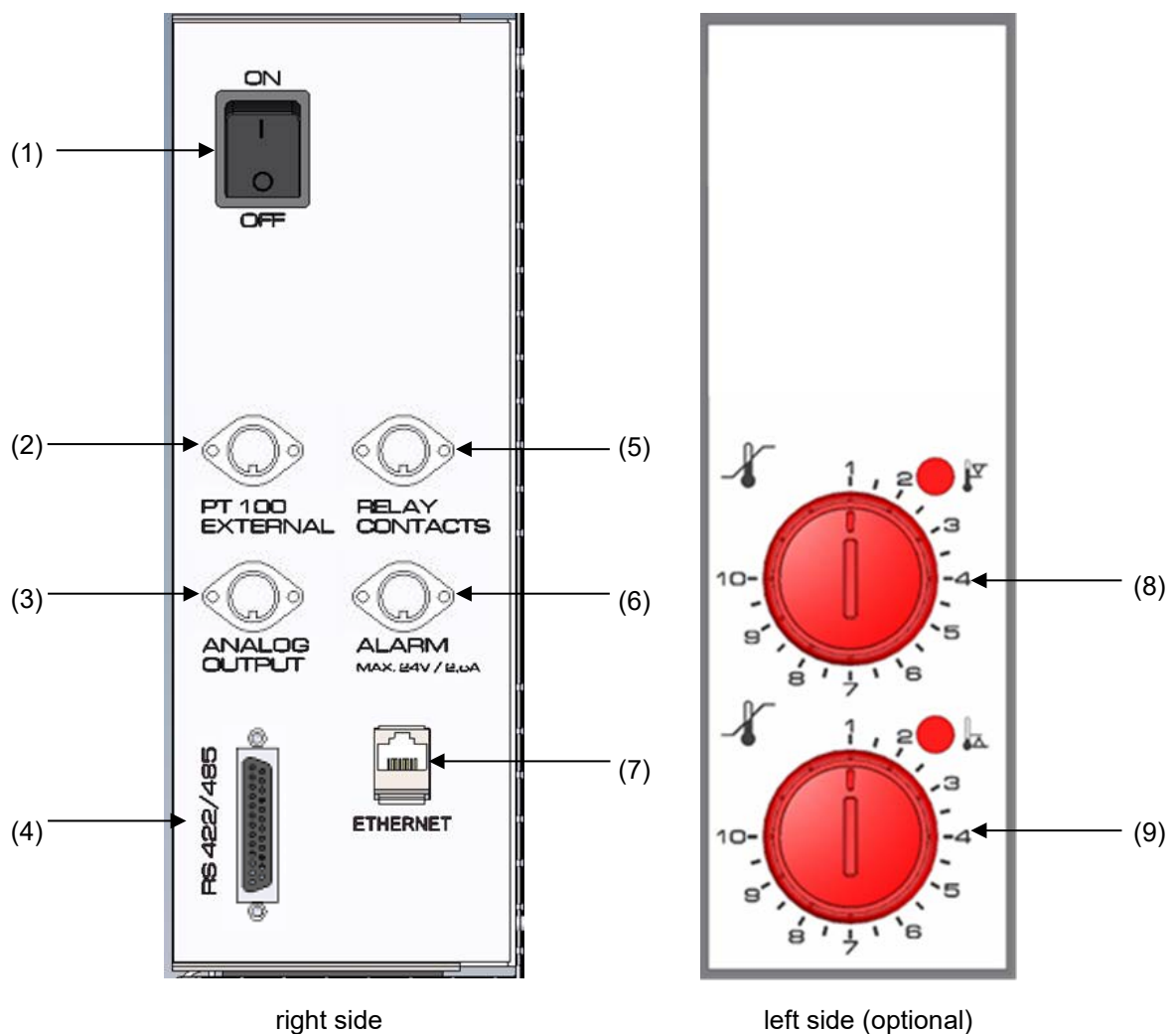

Figure 4: Lateral control panels at the sides of the refrigerating module with optional equipment

- (1) Main power switch
- (2) DIN socket for additional Pt 100 sensor (may be available via BINDER INDIVIDUAL customized solutions)
- (3) DIN socket for analog outputs (option)
- (4) RS485 interface
- (5) DIN socket for switching contacts (may be available via BINDER INDIVIDUAL customized solutions)
- (6) DIN socket for zero-voltage relay alarm output (option)
- (7) Ethernet interface
- (8) Temperature safety device class 3.1 (part of option "Safety device class 3.3")
- (9) Temperature safety device class 3.2 (part of option "Safety device class 3.3")





3. Completeness of delivery, transportation, storage, and installation

3.1 Unpacking, and checking equipment and completeness of delivery

After unpacking, please check the chamber and its optional accessories, if any, based on the delivery receipt for completeness and for transportation damage. Inform the carrier immediately if transportation damage has occurred.

The final tests of the manufacturer may have caused traces of the shelves on the inner surfaces. This has no impact on the function and performance of the chamber.

Please remove any transportation protection devices and adhesives in/on the chamber and on the doors and remove the operating manuals and accessory equipment.

	 CAUTION
	<p>Risk of injury and damages by lifting heavy loads and by sliding or tilting of the chamber due to improper lifting.</p>
	<p>Injuries, damage to the chamber.</p>
	<ul style="list-style-type: none"> ⊘ Do NOT lift or transport the chamber using the door, the handle, or the lower housing. ⊘ Do NOT lift the chamber by hand. ➤ Lift the chamber from the pallet using technical devices (fork lifter). Set the fork lifter only from the front or rear in the middle of the chamber. ⊘ Do NOT set the fork lifter from the chamber side.

If you need to return the chamber, please use the original packing and observe the guidelines for safe lifting and transportation (chap. 3.2).

For disposal of the transport packing, see chap. 22.1.





Note on second-hand chambers (Ex-Demo-Units):

Second-hand chambers are chambers that were used for a short time for tests or exhibitions. They are thoroughly tested before resale. BINDER ensures that the chamber is technically sound and will work flawlessly.

Second-hand chambers are marked with a sticker on the chamber door. Please remove the sticker before commissioning the chamber.

3.2 Guidelines for safe lifting and transportation

The front castors can be blocked by brakes. Please move the chambers with castors only when empty and on an even surface, otherwise the castors may be damaged. After operation, please observe the guidelines for temporarily decommissioning the chamber (chap. 22.2).

  	 CAUTION
	<p>Risk of injury and damages by lifting heavy loads and by sliding or tilting of the chamber due to improper transportation.</p> <p>Injuries, damage to the chamber.</p> <ul style="list-style-type: none"> ➤ Transport the chamber in its original packaging only. ➤ For moving or shipping, secure the chamber with transport straps. ⊘ Do NOT lift or transport the chamber using the door, the handle, or the lower housing. ⊘ Do NOT lift the chamber by hand. ➤ Lift the chamber using technical devices (fork lifter). Set the fork lifter only from the front or rear in the middle of the chamber. ⊘ Do NOT set the fork lifter from the chamber side.

- Permissible ambient temperature range during transport: -10 °C / 14°F to +60 °C / 140°F

You can order transport packing for moving or shipping purposes from BINDER service.

3.3 Storage

Intermediate storage of the chamber is possible in a closed and dry room. Observe the guidelines for temporary decommissioning (chap. 22.2).

- Permissible ambient temperature range during storage: -10 °C / 14°F to +60 °C / 140°F
- Permissible ambient humidity: max. 70 % r.H., non-condensing



When after storage in a cold location you transfer the chamber to its warmer installation site, condensation may form. Before start-up, wait at least one hour until the chamber has attained ambient temperature and is completely dry.

3.4 Location of installation and ambient conditions

Set up the chamber on a flat, even surface, and in a well-ventilated, dry location and align it using a spirit level. The site of installation must be capable of supporting the chamber's weight (see technical data, chap. 23.4). The chambers are designed for setting up inside a building (indoor use).

	NOTICE
	<p>Danger of overheating due to lack of ventilation.</p> <p>Damage to the chamber.</p> <ul style="list-style-type: none"> ⊘ Do NOT install the chamber in unventilated recesses. ➤ Ensure sufficient ventilation for dispersal of the heat. ➤ Observe the prescribed minimum distances when installing the chamber.

Do not install or operate the chamber in potentially explosive areas.

	 DANGER
	<p>Danger of explosion due to combustible dusts or explosive mixtures in the vicinity of the chamber.</p> <p>Serious injury or death from burns and / or explosion pressure.</p> <ul style="list-style-type: none"> ⊘ Do NOT operate the chamber in potentially explosive areas. ➤ KEEP explosive dust or air-solvent mixtures AWAY from the vicinity of the chamber.

Ambient conditions

- Permissible ambient temperature range during operation: +18 °C / 64.4 °F to +32 °C / 89.6 °F. At elevated ambient temperature values, fluctuations in temperature can occur.

	The ambient temperature should not be substantially higher than the indicated ambient temperature of +22 °C +/- 3 °C / 71.6 °F ± 5.4 °F to which the specified technical data relate. Deviations from the indicated data are possible for other ambient conditions.
---	---

	With each degree of ambient temperature >25 °C / 77 °F, the refrigeration power decreases by 1.5 K.
---	---

- Permissible ambient humidity: 70 % r.h. max., non-condensing

When operating the chamber at temperature set-points below ambient temperature, high ambient humidity may lead to condensation on the chamber.

- Installation height: max. 2000 m / 6562 ft. above sea level.

Minimum distances

- When placing several chambers of the same size side by side, maintain a minimum distance of 250 mm / 9.84 in between each chamber.
- Wall distances: rear 100 mm / 3.9 in, sides 160 mm / 6.29 in.
- Spacing above the chamber of at least 100 mm / 3.9 in must also be accounted for.

The chambers are NOT intended for stacking.

	NOTICE
	<p>Danger by stacking.</p> <p>Damage to the chambers.</p> <ul style="list-style-type: none"> ⊘ Do NOT place the chambers on top of each other.

Other requirements

To completely separate the chamber from the power supply, you must disconnect the power plug. Install the chamber in a way that the power plug is easily accessible and can be easily pulled in case of danger.

For the user there is no risk of temporary overvoltages in the sense of EN 61010-1:2010.

With an increased amount of dust in the ambient air, clean the condenser fan (by suction or blowing) several times a year.

Avoid any conductive dust in the ambience according to the chamber layout complying with pollution degree 2 (IEC 61010-1).

4. Installation and connections

4.1 Spacer for wall distance

Please fix both spacers with the supplied screws at the chamber rear. This serves to ensure the prescribed minimum distance to the rear wall of 100 mm / 3.94 in.

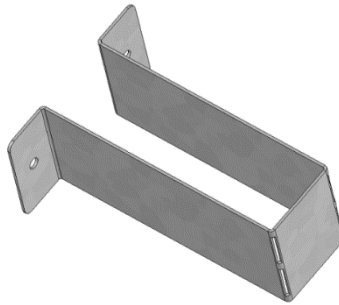

Figure 5: Spacer for wall distance

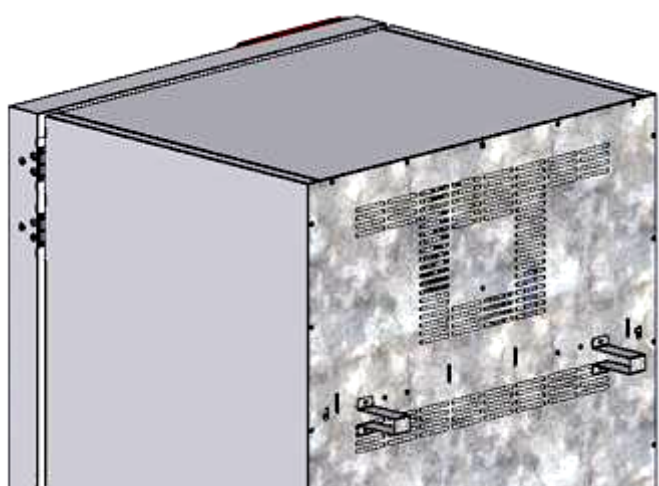

Figure 6: Chamber rear with mounted spacers

4.2 Mounting the flexible tilt protection kit (KBW 400)

KBW size 400 liters should be equipped with the supplied flexible tilt protection kit in addition to the spacers for wall distance (chap. 4.1).

Scope of delivery:

- 4 Torx screws (spare parts)
- 4 tilt protection holders
- 4 securing straps (2 spare parts)

Mounting on device side:

- Remove two screws on the upper part of the rear wall (a)
- Fix two of the supplied tilt protection holders, each centrally with one of these screws (b).

Mounting on wall side

- Fix two of the supplied tilt protection holders in the appropriate distance, each with two screws \varnothing 6mm suitable for the wall (c)

Connection with the securing straps

- On each side, thread one of the supplied securing straps through the provided slots of a device side and a wall side tilt protection holder

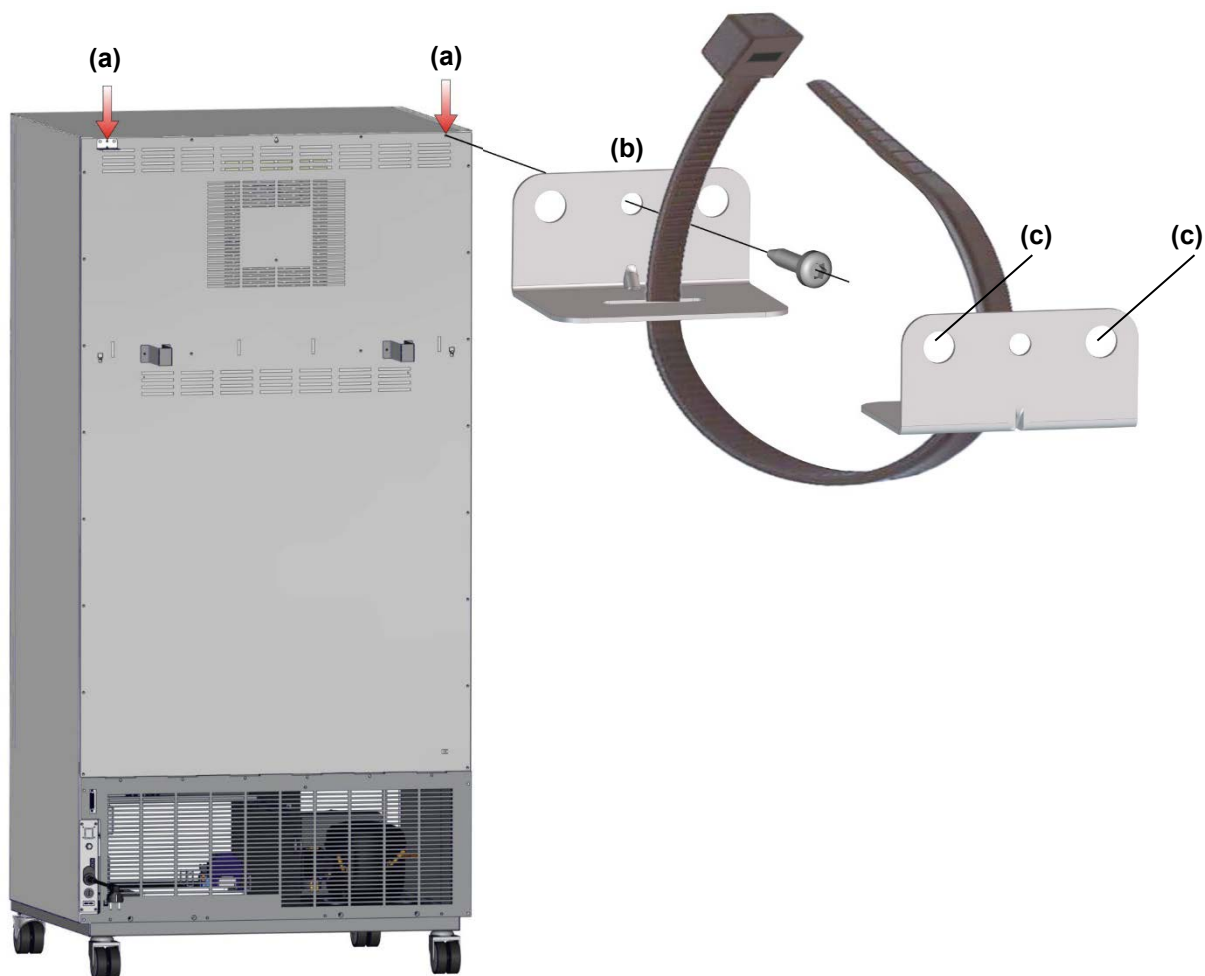

Figure 7: Rear KBW 400 and mounting the flexible tilt protection kit

4.3 Installation and connection of the light cassettes

You can insert the light cassettes in different heights onto the beads at the lateral walls of the chamber. Insert and pull out the light cassettes only by the handles.

Connect the cables of the light cassettes to its closest connection socket at the right side in the back of the chamber.

Put the waterproof plug on the connection socket. When the plug has engaged, turn the locking-nut of the plug several times to the right up to its final stopping point. The plug is now automatically sealed into the socket.

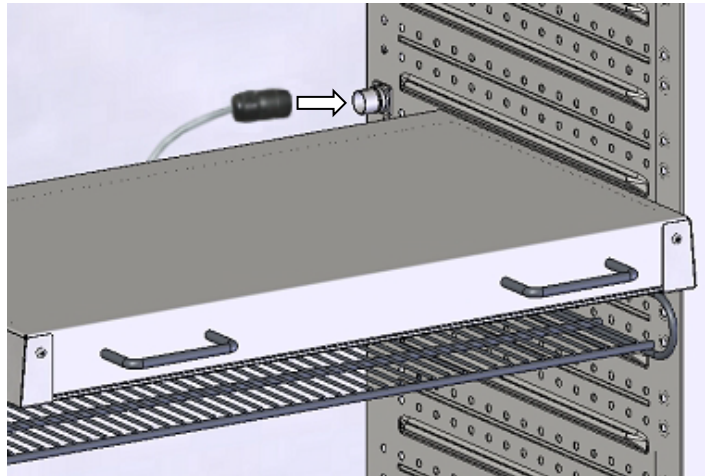

Figure 8: Connecting the light cassettes



Use the covers supplied to protect any unused connection socket.

Do not place any charging material directly onto the light cassettes because those are heated by the fluorescent tubes which would lead to exposing the charging material to undefined temperatures. The temperature directly below or on the light cassettes is not equal to the temperature displayed at the temperature controller.



Place the charging material on the supplied racks below the light cassettes.

The light cassettes will become hot with temperature set-points $>40\text{ }^{\circ}\text{C}$



CAUTION

Danger of burning when touching hot light cassettes

Burns.

- ∅ Do NOT touch the light cassettes during operation.
- Let the light cassettes cool down before changing their position.





When operating the chamber at temperatures $> 60\text{ }^{\circ}\text{C}$ / $140\text{ }^{\circ}\text{F}$, remove the light cassettes. Otherwise, the life expectancy of the fluorescent tubes will be considerably reduced.

4.4 Electrical connection

The chambers are supplied ready for connection. They come with a fixed power connection cable of at least 1800 mm / 70.87 in in length.

Model version	Power plug	Voltage +/-10% at the indicated power frequency	Current type	Chamber fuse
KBW 240	shock-proof plug	200-230 V at 50 Hz	1N~	16 A
KBW 400 KBW 720	shock-proof plug	200-230 V at 50 Hz 200-230 V at 60 Hz	1N~	16 A

- The domestic socket must also provide a protective conductor. Make sure that the connection of the protective conductor of the domestic installations to the chamber's protective conductor meets the latest technology. The protective conductors of the socket and plug must be compatible!

	 DANGER
	<p>Electrical hazard due to missing protective conductor connection.</p> <p>Deadly electric shock.</p> <ul style="list-style-type: none"> ➤ Make sure that the chamber's power plug and the power socket match and securely connect the electrical protective conductors of the chamber and the house installation.

- Only use original connection cables from BINDER according to the above specification.
- Prior to connection and start-up, check the power supply voltage. Compare the values to the specified data located on the chamber's type plate (left chamber side, bottom right-hand, see chap. 1.6).

	NOTICE
	<p>Danger of incorrect power supply voltage due to improper connection.</p> <p>Damage to the chamber.</p> <ul style="list-style-type: none"> ➤ Check the power supply voltage before connection and start-up. ➤ Compare the power supply voltage with the data indicated on the type plate.



- When connecting, please observe the regulations specified by the local electricity supply company as well as the local or national electrical regulations (VDE directives for Germany).
- Observe a sufficient current protection according to the number of devices that you want to operate. We recommend the use of a residual current circuit breaker.
- Pollution degree (acc. to IEC 61010-1): 2
- Installation category (acc. to IEC 61010-1): II

See also electrical data (chap. 23.4).

	<p>To completely separate the chamber from the power supply, you must disconnect the power plug. Install the chamber in a way that the power plug is easily accessible and can be easily pulled in case of danger.</p>
---	--

Remark when operating the chamber with a power frequency of 60 Hz:

When connected to a power supply 1N~ with a frequency of 60 Hz, a leakage current of more than 3.5 mA is possible. If grounding through the power cable is insufficient or missing, the leakage current may flow through the user's body. Correct installation of the professional grade power socket provided by the user safely avoids this. Before connecting the chamber to the socket, please check its grounding contact type plug for appropriate construction and whether it is undamaged.

	 DANGER
	<p>Electrical hazard by high leakage current. Deadly electric shock.</p> <p>➤ Earth connection is essential before connecting supply. Check socket before inserting plug.</p>

5. Functional overview of the MB2 chamber controller

The MB2 chamber controller controls the temperature (closed loop control) and fan speed inside the chamber. Illumination is controlled via the operation lines.

You can enter the desired set point values in fixed value operation mode directly on the display surface or via the setpoint menu. For program operation the controller offers programming week and time programs. In addition, there is a timer program available (stopwatch function).

The controller offers various notifications and alarm messages with visual and audible indication and remote alarms via e-mail, an event list (trace file) and the graphical display of the measuring values in the chart recorder view. The MB2 program controller permits programming temperature cycles, and specifying illumination, fan speed and special controller functions for each program section. You can enter values or programs directly at the controller or use the APT-COM™ 4 Multi Management Software (option) specially developed by BINDER.

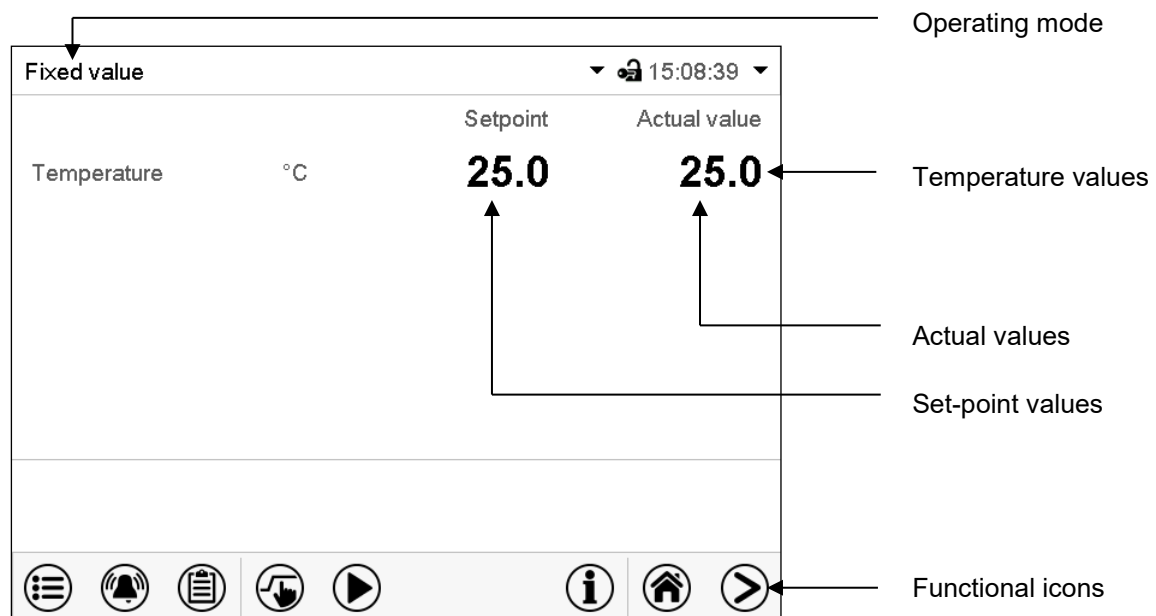

Figure 9: Normal display of the MB2 program controller (sample values)

5.1 Operating functions in normal display

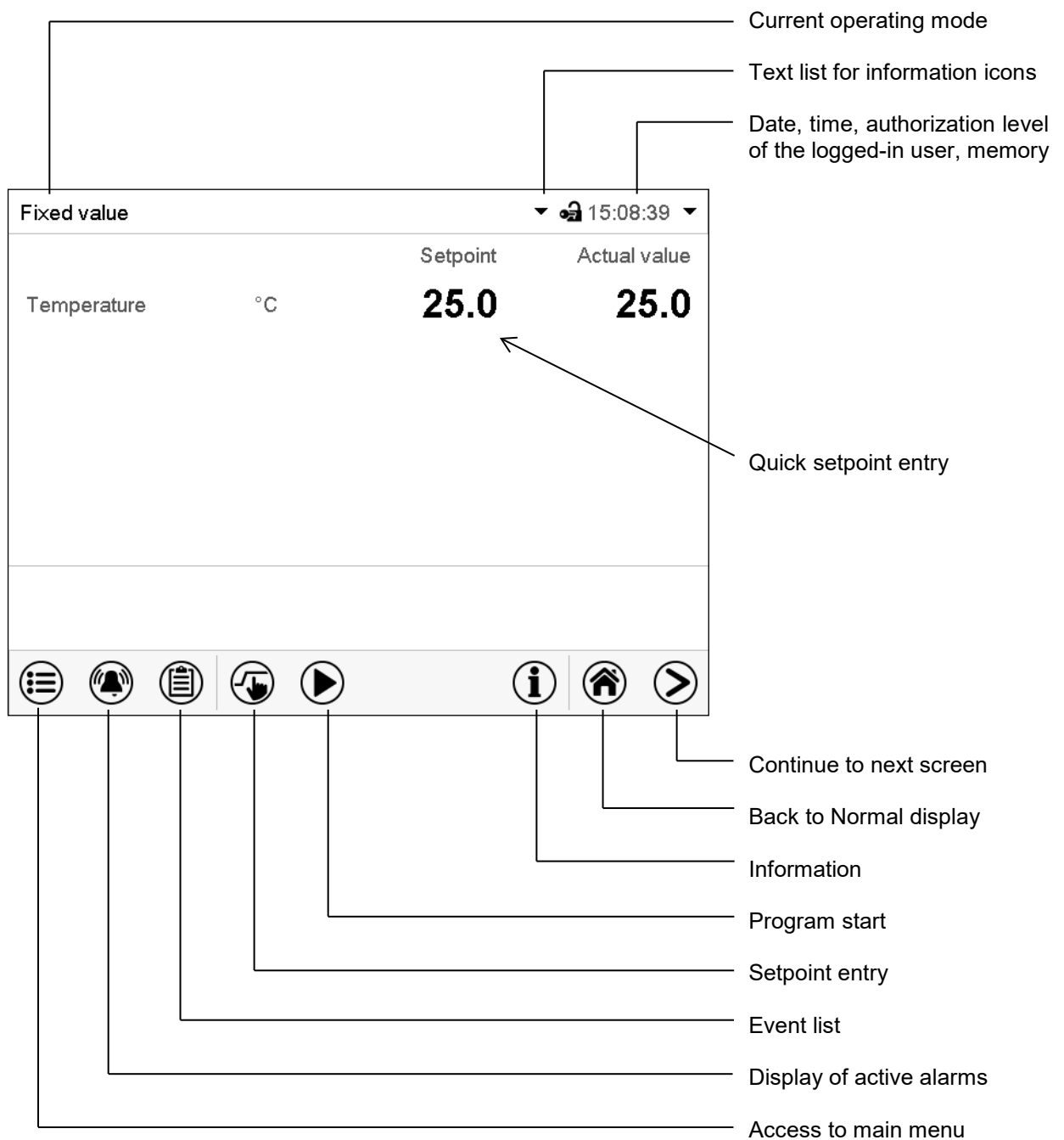

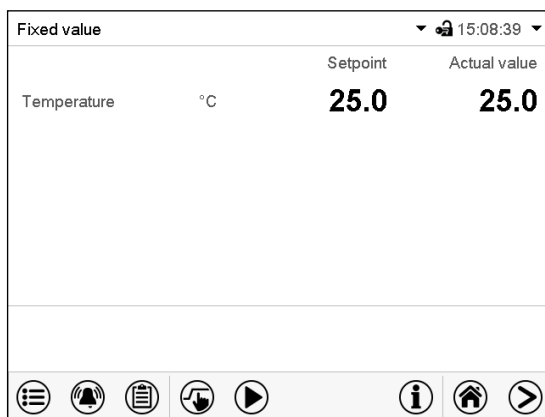

Figure 10: Operating functions of the MB2 controller in normal display (example values)

5.2 Display views: Normal display, program display, chart-recorder display

	Press the Change view icon to toggle between normal display, program display and chart-recorder display.
	Press the Normal display icon to return from program display and chart recorder display back to Normal display.



Normal display (actual values / setpoint values)

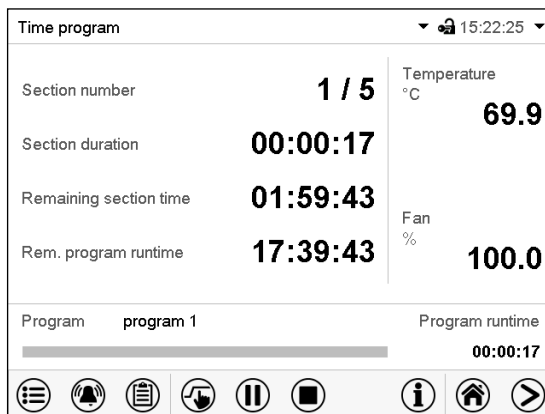

Program display (example: time program)

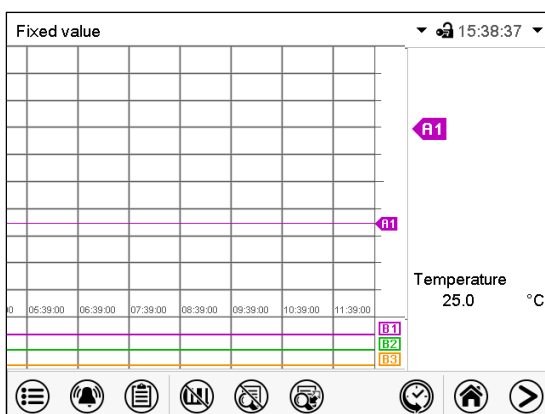



















Chart recorder display

5.3 Controller icons overview











Navigation icons in Normal display

Icon	Signification	Function
	Main menu	Access from Normal display to the main menu
	Alarm	Access from Normal display to the list of active alarms
	Event list	Access from Normal display to the event list
	Setpoint setting	Access from Normal display to the setpoint entry menu: setpoint entry for Fixed value operation, safety controller settings
	Program start	Start a previously entered time or week program, continue a paused time program
	Program pause	Pause a running time program
	Program cancelling	Cancel a running time or week program
	Information	Information on program operation, setpoints, actual values, and the safety controller
	Normal display	Return from program display or chart recorder display to Normal display
	Change view	Toggle between Normal display, program display, and chart recorder display





Functional icons in individual menus

Icon	Signification	Function
	Back	Return from each menu to Normal display
	Update	Update the event list and alarm messages
	Confirm	Take over the entries and exit the menu / continue menu sequence.
	Close	Exit the menu / cancel menu sequence. Entries are not taken over. When terminating a menu sequence, an information window appears, which must be confirmed.
	Reset alarm	Acknowledge the alarm and mute the buzzer.
	Change keyboard	Change between uppercase and lowercase characters, digits and special characters
	Edit	Edit settings of time and week programs

Functional icons in the chart recorder display

Icon	Signification	Function
	Show legend	Show legend
	Hide legend	Hide legend
	Switch legend	Switch between legend pages
	Show indications	Show the indications "Door open" (B1), "Light Level 1" (B2) and "Light Level 2" (B3).
	Hide indications	Hide the indications "Door open" (B1), "Light Level 1" (B2) and "Light Level 2" (B3).
	History display	Pause chart recorder and change to history display. Data recording continues.
	Curve selection	Go to "Curve selection" submenu in the history display
	Search	Go to "Search" submenu in the history display to select the required instant
	Zoom	Go to "Zoom" submenu in the history display to select the zoom factor
	Show scroll buttons	Show scroll buttons in the history display to scroll to an instant
	Hide scroll buttons	Hide scroll buttons in the history display to scroll to an instant

Information icons referring to chamber conditions

Icon	Text information	Condition
	"Idle mode"	Controller in Idle mode
	"Temperature range"	Current actual temperature value outside the tolerance range
	"Door open"	Chamber door is open
	"Light level 1"	Light level 1 (40% illumination) turned on (operation line "Light level 1" activated)
	"Light level 2"	Light level 2 (60 % illumination) turned on (operation line "Light level 2" activated)

Information icon for data processing

Icon	Information
	Waiting icon: Data processing is running. Remaining time to touch the display when calibrating the touchscreen.

5.4 Operating modes

The MB2 program controller operates in the following operating modes:

- **Idle mode**

The controller is not functional, i.e., there is no heating or refrigeration. The fan is off. The chamber approximates ambient values.

The fluorescent tubes are off.

You can activate and deactivate this operating mode with the “Idle mode” control contact in Fixed value operating mode (chap. 7.4), time program operation (chap. 9.7.3) and week program operation (chap. 10.6.5).

- **Fixed value operating mode**

The controller operates as a fixed-point controller, i.e., set-points can be defined, which are then maintained until the next manual change (chap. 7.1).

- **Timer program operation**

Stopwatch function: during an entered duration the controller constantly equilibrates to the setpoints entered in Fixed value operation mode.

- **Time program operation**

An entered time program for temperature is running. The controller offers 25 program memory places with 100 program sections each. The total number of program sections of all programs is unlimited

- **Week program operation**

An entered week program for temperature is running. The controller offers 5 program memory places with 100 switching points each. The switching points can be distributed over all days of the week.



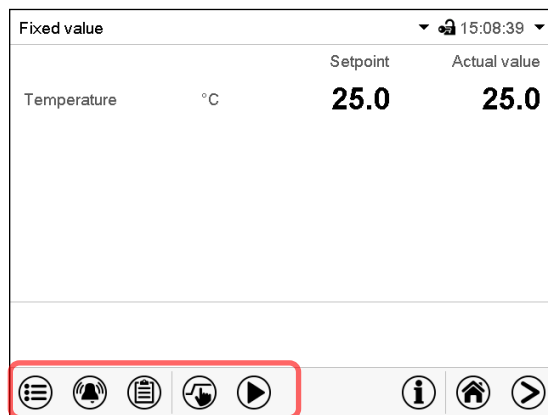

5.5 Controller menu structure

Use the **navigation icons** in the screen footer in Normal display to access the desired controller functions.



Normal display



The available functions depend on the current **authorization level** "Service", "Admin" or "User" (chap. 13.1). This is selected either during login or can be available without password protection.

	Main menu: program settings, further information, "Service" submenu. The "Settings" submenu allows general configuration of the controller.	chap. 5.5.1
	List of active alarms	chap. 11.3
	Access to the event list	chap. 15.2
	Setpoint entry for Fixed value operation, safety controller settings	chap. 7, 12.2
	Start/ pause/ cancel an already entered, respectively a running time program or start / cancel an already entered, respectively a running week program	chap. 9.1, 9.2, 10.1



Unless noted otherwise, the figures show the functional range, which is available for the user with "Admin" authorization level.

5.5.1 Main menu

The main menu provides access to the general configuration of the controller as well as to program entry and the user administration. Additionally, there are support functions like a contact page or the display calibration depending on the available angle.

	Press the Main menu icon to access the main menu from Normal Display.
	Press the Back icon to return from each setting menu to Normal Display.

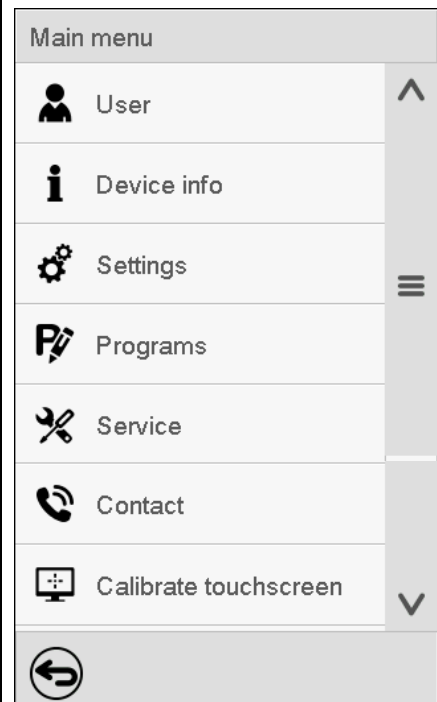
The main menu provides the following functions and submenus.

			
	User	User management: login and logout, password management	chap. 13
	Device info	Chamber information	chap. 15.2
	Settings	“Settings” submenu (not visible for user with “User” authorization level)	chap. 14
	Programs	Program entry submenu for time and week programs	chap. 9 and 10
	Service	“Service” submenu	chap. 5.5.3
	Contact	BINDER Service contact page	chap. 15.1
	Calibrate touchscreen	Calibrating the touch screen	chap. 14.4.2
	Back to Normal Display		

“Settings” submenu

- Settings of many general controller functions and network settings (chap. 14).
- Available only for users with “Service” and “Admin” authorization level

“Service” submenu

- Access to service data, controller reset to factory settings (chap. 5.5.3)
- Available only for users with “Service” and “Admin” authorization level. Full functional range only for BINDER Service (users with “Service” authorization level).

“Programs” submenu

- Access to the controller’s program functions (chap. 8, 9, 10)

5.5.2 “Settings” submenu

The “Settings” submenu is available for users with “Service” or “Admin” authorization level. It serves to enter date and time, select the language for the controller menus and the desired temperature unit and to configure the controller’s communication functions.

Path: [Main menu](#) > [Settings](#)

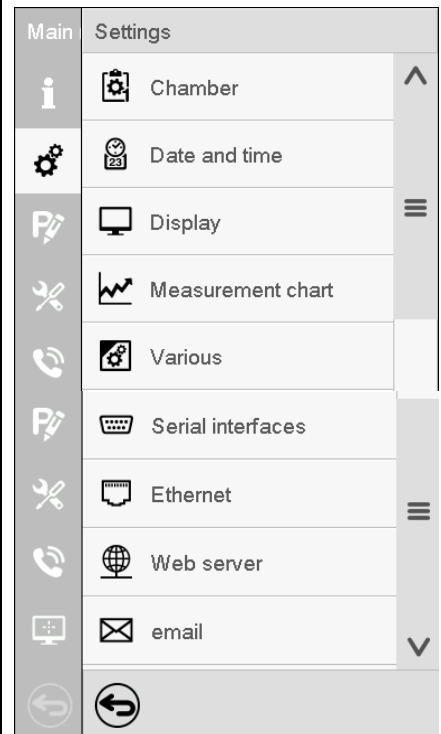
	Setting the temperature unit, menu language...	chap. 14.1, 14.2
	Setting date and time	chap. 14.2
	Setting the display brightness, continuous operation and screen saver	chap. 14.4
	Settings for the measurement chart: storage interval, storage values, minimum and maximum values	chap. 16.2
	Setting the tolerance range and delay time for tolerance range alarm	chap. 11.4
	Configuration of the optional RS485 interface, setting of the device address	chap. 14.5.1
	Entry of the MAC address and IP address	chap. 14.5.2
	Password protection for web server access	chap. 14.5.3
	Configuration of the e-mail server, assignment of e-mail addresses	chap. 14.5.4
	Back to main menu	

5.5.3 “Service” submenu

The “Service” submenu is available for users with “Service” or “Admin” authorization level. When logged-in with “Admin” authorization level the user will find information to tell the BINDER Service in service case.

Path: [Main menu](#) > [Service](#)

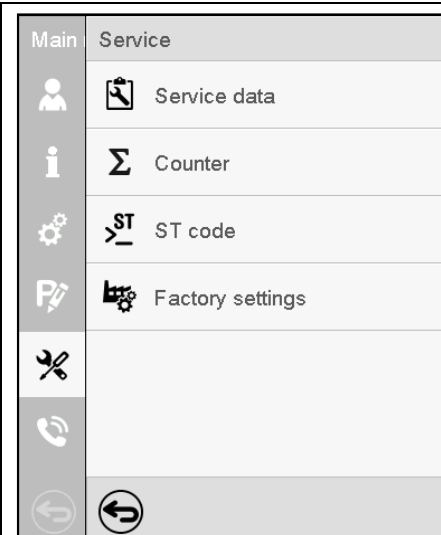
	Serial number of the chamber, setup version of the controller software	chap. 14.2
	No function	
	Information for BINDER Service	
	Reset to factory settings	
	Back to main menu	

(view with “Admin” authorization level)

5.6 Principle of controller entries

In the selection and entry menus there are icons displayed in the footers which you can use to take over the entry or cancel it.

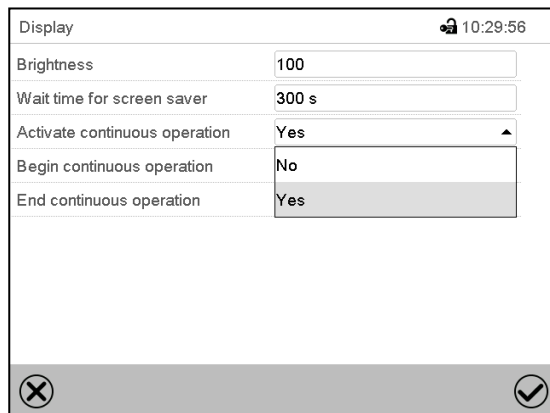

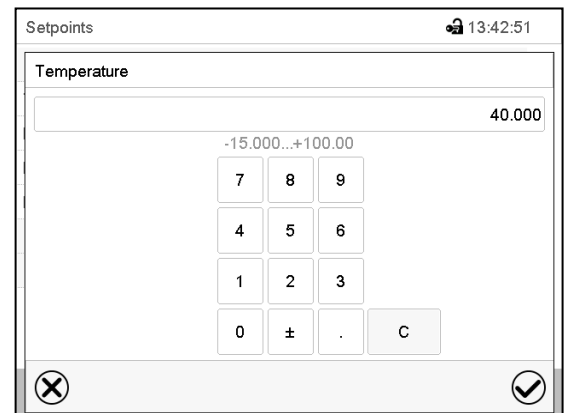

Selection menu (example)



Entry menu (example)

After completing the settings there are the following possibilities:

	Press the Confirm icon to take over the entries and exit the menu or continue the menu sequence.
	Press the Close icon to exit the menu or cancel the menu sequence without taking over the entries. When terminating a menu sequence, an information window appears, which must be confirmed.

5.7 Performance during and after power failures

During a power failure, all controller functions are shut down. The zero-voltage relay alarm output (option, chap. 19.5) is switched to alarm position for the whole duration of the power failure.

After the power returns, all functions return to the same status the chamber had before power failure. . The controller continues to function in the original operating mode it was in previously before the power failure occurred.

- Performance after power failure in Idle mode
Control is deactivated
- Performance after power failure in Fixed value operation mode
All functions return to the same status the chamber had before power failure. The set-points are immediately resumed.
- Performance after power failure during time program operation
The program is resumed at the point where the interruption occurred with the latest set-points reached during the program run.
- Performance after power failure during week program operation
The week program continues with the values corresponding to the current time.

Power failure and power return are noted in the event list (chap. 15.3).

If during power failure an alarm has occurred (tolerance range, safety controller, temperature safety device class 3.3 (option), confirm the alarm. See chap. 11.3.

5.8 Performance when opening the door

When you open the door, the fan starts running with minimum speed.

After 60 seconds from opening the door, heating, refrigeration, and fan turn off.

After closing the door, heating, refrigeration, and fan turn on again.

6. Start up

6.1 Turning on the chamber

After connecting the supply lines (chap. 4.4), turn on the chamber by its main power switch (1). The lit pilot lamp shows the chamber is ready for operation.

When the main power switch is turned on and yet the controller display is dark, the display is in stand-by mode. Press on the touchscreen to activate it.

Warming chambers may release odors in the first few days after commissioning. This is not a quality defect. To reduce odors quickly we recommend heating up the chamber to its nominal temperature for one day and in a well-ventilated location.

	<p>WARNING: If customer should use a BINDER chamber running in non-supervised continuous operation, we strongly recommend in case of inclusion of irrecoverable specimen or samples to split such specimen or samples and store them in at least two chambers, if this is feasible.</p>
--	--

6.2 Controller settings upon start up

The window “Language selection” enables the **language selection**, in case that it’s activated in the “Start-up” menu. Afterwards occurs a request of the **time zone** and the **temperature unit**.

<p>Language selection</p> <p>German</p> <p>English</p> <p style="text-align: right;">✓</p>	<p>Start-up</p> <p>Temperature unit: Degrees Celsius</p> <p>Time zone: UTC+1h (CET)</p> <p>Daylight saving time switch: Automatic</p> <p>Start of daylight saving time</p> <p>End of daylight saving time</p> <p>Language query after restart: Yes</p> <p style="text-align: right;">✗ ✓</p>
--	--

The controller will function in the **operating mode**, which was active before the last shut-down. It controls temperature in fixed value operating mode to the last entered value and in the program mode to the set point achieved beforehand.

Locked operation

Provided that the user administration has been activated by the assignment of passwords for the different authorization types, the **controller operation** is first locked after turning on the unit, recognizable by the closed lock icon in the header.

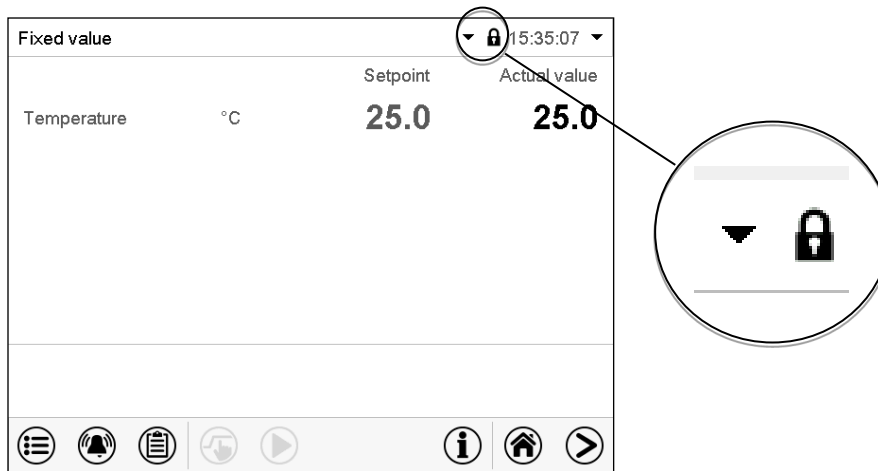

In the locked view the controller provides all display functions. No setting functions are available.

The setpoints are shaded (light grey) in normal display. Changing them by direct entry in the fixed value operating mode is not possible. The functional icons for setpoint entry and program start in the footer are without function.

After turning on the unit, user log-in is required to operate the controller (chap. 13.2)

Operation without user log-in / without password-protection

If the password function has been deactivated, after turning on the unit without user log-in there are those controller functions available, which correspond to the highest authorization level without a password protection. There is no lock icon in the header.

7. Set-point entry in “Fixed value” operating mode

In Fixed value operating mode, you can enter a temperature set-point, the fan speed, and the switching-state of special controller functions via operation lines.

All settings made in Fixed value operating mode remain valid until the next manual change. They are saved also when turning off the chamber or in case of toggling to Idle Mode or Program Mode.

	Setting ranges	Control ranges
Temperature	-5 °C / 41 °F up to 70 °C / 158 °F.	0 °C / 32 °F up to 70 °C / 158 °F without light +5 °C / 41 °F up to +60 °C / 140 °F with maximum light intensity
Fan speed	40% up to 100 %	



Reduce the fan speed only if required, because the spatial distribution of temperature will also be reduced.

Technical data refers to 100% fan speed.



With set-point type “**Limit**”, adapt the safety controller (chap. 12.2) or the temperature safety device class 3.3 (option, chap.12.3) always when you changed the temperature set-point. Set the safety controller set-point or the set-point of temperature safety device class 3.3 (option) by approx. 2 °C to 5 °C above the controller temperature set-point.

Recommended setting: Set-point type “**Offset**” with safety controller set-point 2 °C.

7.1 Set-point entry for temperature and fan speed through the “Setpoints” menu

 Press the **Setpoint setting** icon to access the “Setpoint” setting menu from Normal display.

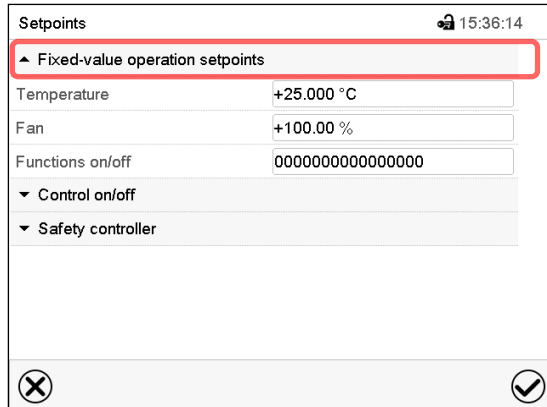

“Setpoints” menu.

Select “Fixed value operation setpoints” to access the individual parameters.

- Select the field “Temperature” and enter the desired temperature setpoint.
Setting range: -5 °C up to 70 °C. Confirm entry with **Confirm** icon.
- Select the field “Fan” and enter the desired fan speed setpoint.
Setting range: 40% up to 100% fan speed. Confirm entry with **Confirm** icon.

 When entering a value outside the setting range, the message: “Value outside of limits! (Min: xxx, Max: xxx)” appears (xxx is a wildcard for the limits of the respective parameter). Press the **Confirm** icon and repeat the entry with a correct value.

After completing the settings, press the **Confirm** icon to take over the entries and exit the menu, **or** press the **Close** icon to exit the menu without taking over the entries.

7.2 Direct setpoint entry for temperature via Normal display

Alternatively you can also enter the setpoints directly via Normal display.

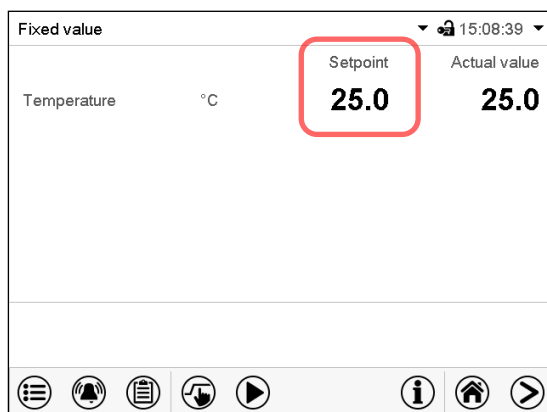

Normal display.

Select the temperature setpoint.

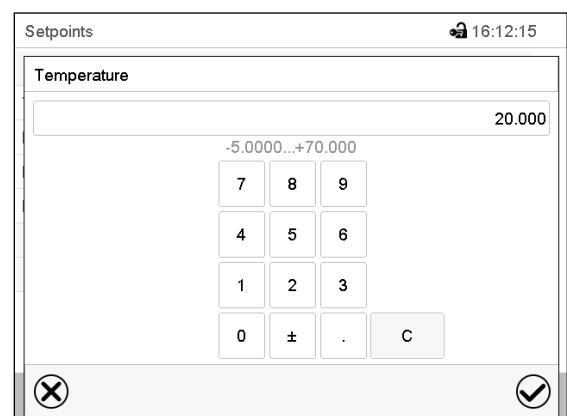

“Temperature” entry menu.

Enter the desired setpoint and confirm entry with **Confirm** icon.

7.3 Automatic correction of the actual value when turning on or off the illumination

The chambers have been adjusted for operation with maximum illumination. Since the illumination creates a heat input in the chamber, this is considered automatically when operating without illumination.

This can be recognized when turning on or off the illumination by a change of the actual temperature value, which subsequently will equilibrate again to the set-point.

7.4 Light commutation and special controller functions via operation lines



Press the **Setpoint setting** icon to access the “Setpoint” setting menu from Normal display.

You can define the switching state of up to 16 operation lines (control contacts). They are used to activate / deactivate special controller functions.

- Operation line “Idle mode” activates / deactivates the operating mode “Idle mode” (chap. 5.4).
- Operation lines “Light level 1” and “Light level 2” serve to turn on/off the fluorescent tubes

The other operation lines are without function.

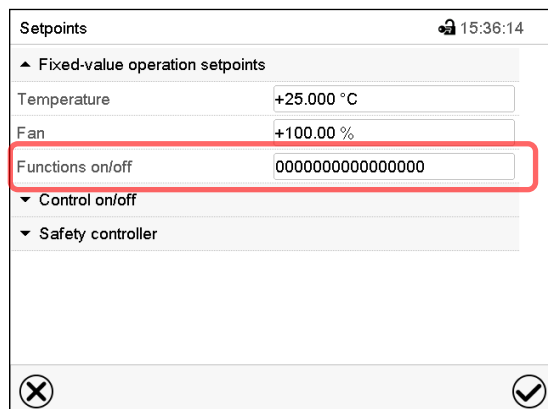
Use the “Setpoints” menu to configure the operation lines.



“Setpoints” menu.

Select the field “Functions on/off”.

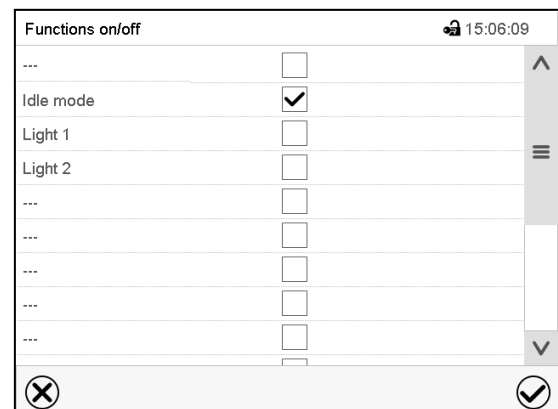

“Functions on/off” entry menu.

Mark / unmark the checkbox to activate / deactivate the desired function and press the **Confirm** icon.

Activated operation line: switching status “1” (On)

Deactivated operation line: switching status “0” (Off)

The operation lines count from right to left.

Example:

Activated operation line “Idle mode” = 0000000000000000**1**

Deactivated operation line “Idle mode” = 0000000000000000**0**

8. Timer program: stopwatch function

During an entered duration the controller constantly equilibrates to the setpoints entered in Fixed value operation mode (temperature, fan speed, configuration of the operation lines). This duration can be entered as a “Timer program”. During the program runtime, any setpoint changes do not become effective; the controller equilibrates to the values which were active during program start.

8.1 Starting a timer program

 In Normal display press the **Program start** icon to access the “Program start” menu.

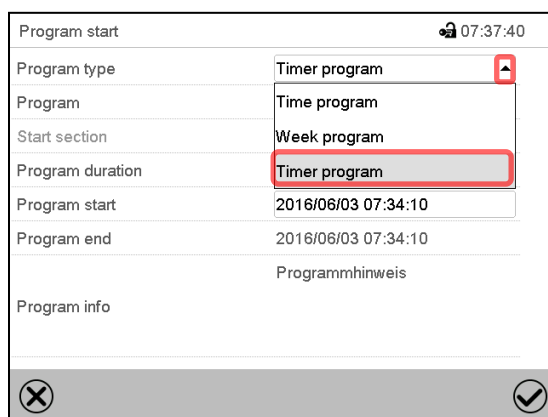

“Program start” menu

- In the field “Program type” select “Timer program”.
- Select the field “Program duration” and enter the desired program duration. Press the **Confirm** icon.
- Select the field “Program start” and enter the desired start time of the program in the “Program start” entry menu. Press the **Confirm** icon. The program delay time until program start begins.

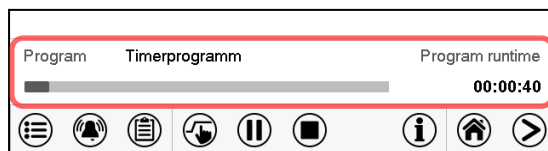

Normal display.

Information on the bottom of the screen indicates the currently running program and the time already passed. The grey bar shows how much time of the whole time is elapsed.

8.1.1 Performance during program delay time

During the configured program delay time until program start, the controller equilibrates to the current setpoints of Fixed value operation mode. Modifications of these setpoints are possible but become effective only after the timer program is finished. When the configured moment for program start is reached, the program delay time ends and the program starts running. The controller equilibrates to the values which had been active during program start



8.2 Stopping a running timer program

8.2.1 Pausing a running timer program

	Press the Program pause icon to interrupt the program.
---	---

The program is paused. The program runtime stops running down, the time display flashes.

There are the following options:

	Press the Program start icon to continue the program
	Press the Cancelling icon to cancel the program

8.2.2 Cancelling a running timer program

	Press the Program cancelling icon to cancel the program.
---	---

A confirmation prompt is displayed. Press the **Confirm** icon to confirm that the program shall really be cancelled.

After confirming the message, the controller changes to Fixed value operation mode. The setpoints of Fixed value operation mode will then equilibrate.

8.3 Performance after the end of the program

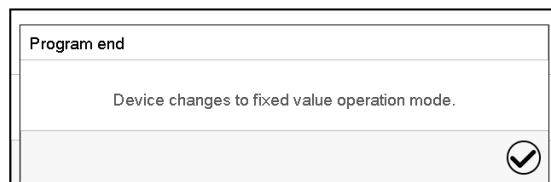

After the end of the program the message "Device changes to fixed value operation mode" appears on the screen.

Press the **Confirm** icon.

After confirming the message, the controller changes to Fixed value operation mode. The setpoints of Fixed value operation mode will then equilibrate.

9. Time programs

The MB2 program controller permits programming time programs with real-time reference. It offers 25 program memory positions with up to 100 program sections each.

For each program section you can enter a temperature set-point, fan speed, section duration, type of temperature transition (ramp or step) and the tolerance range.



If the safety controller has been set to “limit” mode, check the setting of the safety controller when changing the temperature set-point, (chap. 12.2).



Reduce the fan speed only if required, because the spatial distribution of temperature will also be reduced.

Technical data refers to 100% fan speed.

Programming remains saved in case of a power failure or after turning off the unit.

Path: [Main menu](#) > [Programs](#) > [Time program](#)

9.1 Starting an existing time program



In Normal display press the **Program start** icon to access the “Program start” menu.

Program start		🔔 08:07:19
Program type	Time program	▼
Program	program 1	▼
Start section	1	
Program duration		
Program start	2016/06/03 08:04:24	
Program end	2016/06/06 23:04:24	
Program info		
<div style="display: flex; justify-content: space-between;"> ⊗ ✔ </div>		

“Program start” menu

- In the field “Program type” select the setting “Time program”.
- In the field “Program” select the desired program.
- Select the field “Program start” and enter the desired program start time in the “Program start” entry menu. Press the **Confirm** icon. The program delay time until program start begins.

The program end is adapted automatically depending on the entered program duration.

After completing the settings, press the **Confirm** icon to take over the entries and exit the menu. The program starts running.

If instead you press the **Close** icon to exit the menu without taking over the entries, the program will not start.

Program	program 1	Program runtime
<div style="background-color: grey; width: 100%; height: 10px;"></div>		00:01:23
		

Normal display. Information on the bottom of the screen indicates the currently running program and the time already passed. The grey bar shows how much time of the whole time is elapsed. If program duration has been set to infinite, the grey bar is not displayed.

9.1.1 Performance during program delay time

During the configured program delay time until program start, the controller equilibrates to the current setpoints of Fixed value operation mode. Modifications of these setpoints are effective. When the configured moment for program start is reached, the program delay time ends and the program starts running.



9.2 Stopping a running time program

9.2.1 Pausing a running time program

	Press the Program pause icon to interrupt the program.
---	---

The program is paused. The program runtime stops running down, the time display flashes.

There are the following options:

	Press the Program start icon to continue the program
	Press the Cancelling icon to cancel the program

9.2.2 Cancelling a running time program

	Press the Program cancelling icon to cancel the program.
---	---

A confirmation prompt is displayed. Press the **Confirm** icon to confirm that the program shall really be cancelled.

After confirming the message, the controller changes to Fixed value operation mode. The setpoints of Fixed value operation mode will then equilibrate.

9.3 Performance after the end of the program

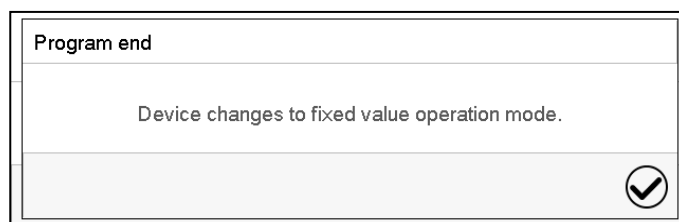

After the end of the program the message "Device changes to fixed value operation mode" appears on the screen.

Press the **Confirm** icon.

As long as the message has not been confirmed, the setpoint of the last program section remains effective. Program the last section as desired. If e.g. heating and refrigeration shall turn off, activate operation line "Idle mode" in the last program section.

After confirming the message, the controller changes to Fixed value operation mode. The setpoints of Fixed value operation mode will then equilibrate.

9.4 Creating a new time program

Path: [Main menu](#) > [Programs](#) > [Time program](#)

No.	Program name
1	program 1
2	program 2
3	< empty >
4	< empty >
5	< empty >
6	< empty >
7	< empty >
8	< empty >
9	< empty >
10	< empty >

“Time program” menu:
overview of the existing programs.
Select an empty program place.



Program name

Program info

Enter the program name and, if desired, additional program information in the corresponding fields.

Press the **Confirm** icon.

The program view opens (chap. 9.5).

9.5 Program editor: program management

Path: [Main menu](#) > [Programs](#) > [Time program](#)

No.	Program name
1	program 1
2	program 2
3	program 3
4	< empty >
5	< empty >
6	< empty >
7	< empty >
8	< empty >
9	< empty >
10	< empty >

“Time program” menu:
overview of the existing programs.

Select an existing program (example: program 3) or create a new program (chap. 9.4).

The program view opens.



No.	Duration [hh:mm:ss]	Temperature [°C]	Fan [%]
1	02:00:00	70.000	100.00

Program view (example: program 3).

If a new program has been created, there is just one program section.

There are the following options:

- ① Select a program section to open the section editor (chap. 9.6)
- ② Press the **Edit** icon to open the program editor

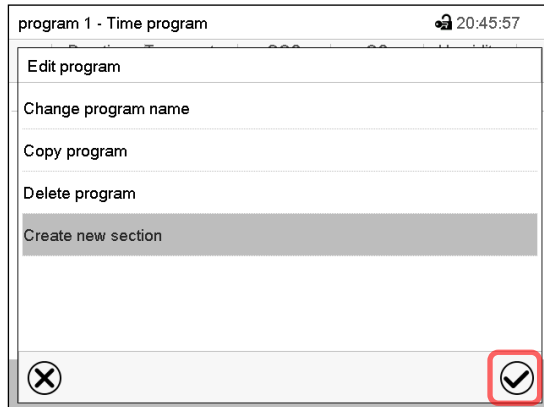

Program editor: “Edit program” menu

Select the desired function and press the **Confirm** icon.

The program editor offers following options:

- Change the program name
- Copy program
- Replace program: Replacing a new or an existing program with the copied program. This menu point is visible only after a program has been copied.
- Delete program
- Create new section

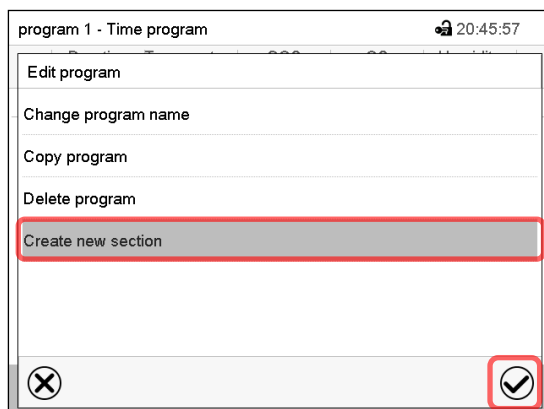

To add a new section, select “Create new section” and press the **Confirm** icon.

The program view opens.

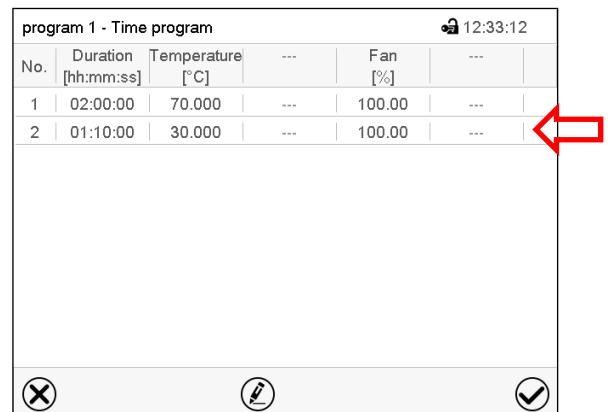
No.	Duration [hh:mm:ss]	Temperature [°C]	...	Fan [%]	...
1	02:00:00	70.000	...	100.00	...
2	01:10:00	30.000	...	100.00	...

Program view.

A new section is always added at the very bottom (example: section 2).

9.5.1 Deleting a time program

Path: [Main menu](#) > [Programs](#) > [Time program](#)

In the “Time program” menu select the program to be deleted. The program view opens.



In the **program view** press the **Edit** icon to open the program editor



In the **program editor** select “Delete program” and press the **Confirm** icon.

The program is deleted. The controller returns to the program view.

9.6 Section editor: section management

Path: [Main menu](#) > [Programs](#) > [Time program](#)

Select the desired program.

No.	Duration [hh:mm:ss]	Temperature [°C]	...	Fan [%]	...
1	02:00:00	70.000	---	100.00	---
2	01:10:00	30.000	---	100.00	---

Program view.

Select the desired program section (example: section 1)



program 1 - Section number 1		12:40:17
Duration	02:00:00	
Course	Ramp	①
Functions on/off	0000000000000000	
Number of repetitions	0	
Start section for repetition	1	
Temperature	+70.000	
Tolerance band min.	+0.0000	
Tolerance band max.	+0.0000	
Fan	+100.00	

Section view (example: section 1).

There are the following options:

- ① Select a parameter to enter or modify the according value (chap. 9.7)
- ② Press the **Edit** icon to open the program editor



program 1 - Section number 1		23:22:19
Edit section		
Copy section		
Delete section		
Create new section		

Section editor: "Edit section" menu

Select the desired function and press the **Confirm** icon.

The section editor offers following options:

- Copy section
- Replace section: Replacing an existing section with the copied section. This menu point is visible only after a section has been copied.
- Insert section: Adding the copied section. This menu point is visible only after a section has been copied.
- Delete section
- Create new section

9.6.1 Add a new program section

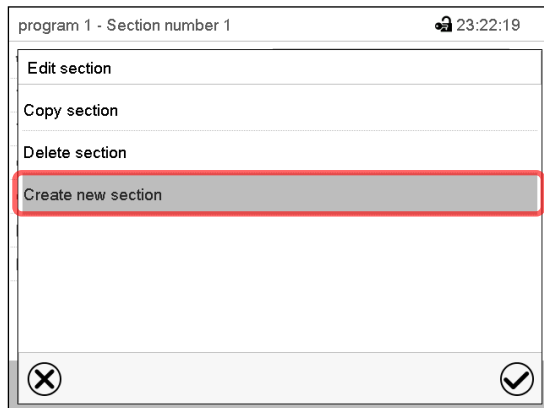

Section editor: "Edit section" menu.

Select "Create new section" and press the **Confirm** icon.

Then select whether to insert the new section before or after the current section.

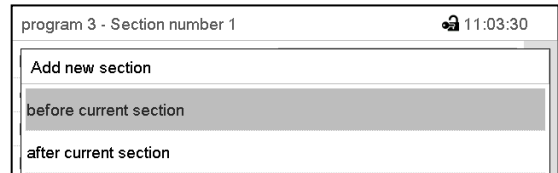

Press the **Confirm** icon. The new section opens.

9.6.2 Copy and insert or replace a program section

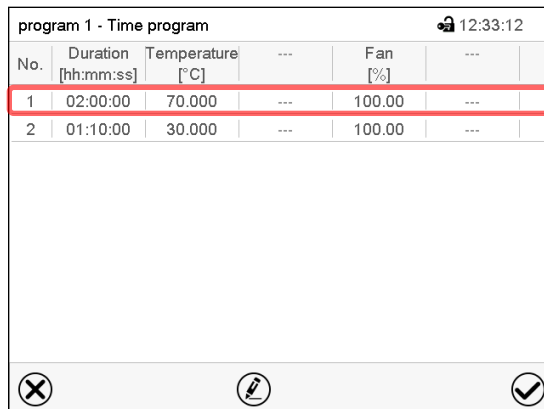

Program view.

Select the program section to be copied (example: section 1)

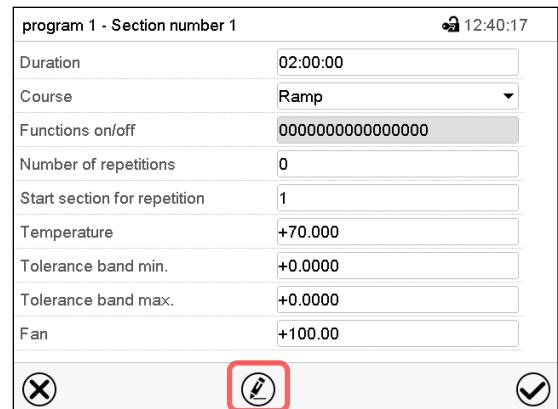

Section view (example: section 1).

Press the **Edit** icon to open the section editor.

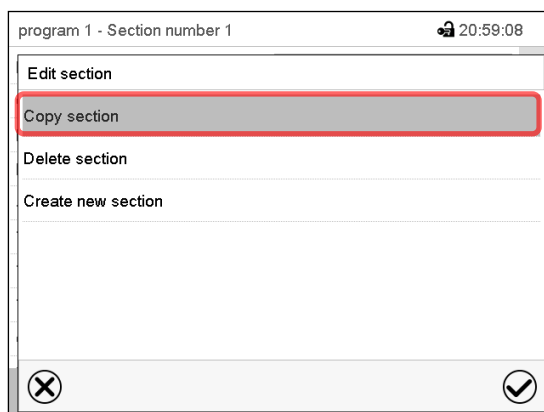

Section editor: "Edit section" menu

Select "Copy section" and press the **Confirm** icon.

The current section (example: section 1) is copied. The controller returns to the section view.

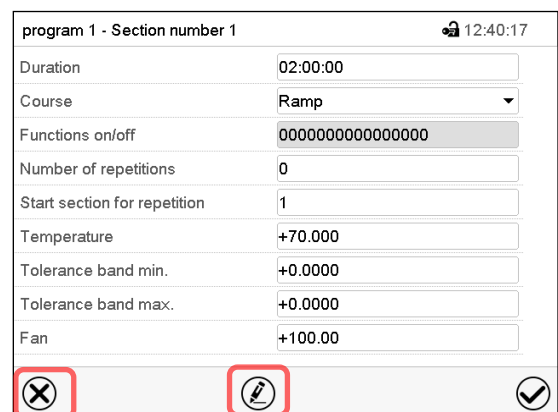

Section view (example: section 1).

Press the **Close** icon to change to the program view, if you want to select another section to be replaced or before or after which the copied section shall be inserted...

or

Press the **Edit** icon to open the section editor if you want the current section to be replaced or the copied section to be inserted before or after it

program 1 - Time program 12:33:12

No.	Duration [hh:mm:ss]	Temperature [°C]	---	Fan [%]	---
1	02:00:00	70.000	---	100.00	---
2	01:10:00	30.000	---	100.00	---

✕ ✓

Program view.

Select the section to be replaced or before or after which the copied section shall be inserted (example: section 2) and press the **Confirm** icon.

program 1 - Section number 1 12:40:17

Duration: 02:00:00

Course: Ramp

Functions on/off: 0000000000000000

Number of repetitions: 0

Start section for repetition: 1

Temperature: +70.000

Tolerance band min.: +0.0000

Tolerance band max.: +0.0000

Fan: +100.00

✕ ✓

Section view (example: section 1).

Press the **Edit** icon to open the section editor

program 1 - Section number 1 21:00:40

Edit section

Copy section

Replace section

Insert section

Delete section

Create new section

✕ ✓

Section editor: "Edit section" menu

Select "Replace section" to replace the selected section with the copied section

or

Select "Insert section" to additionally add the copied section.

In this case select whether to insert it before or after the selected section.

Insert section

before current section

after current section

Press the **Confirm** icon

9.6.3 Deleting a program section

In the **program view** select the program section to be deleted. The section view opens.



In the **section view** press the **Edit** icon to open the section editor



In the **section editor** select "Delete section" and press the **Confirm** icon.

The section is deleted. The controller returns to the section view.

9.7 Value entry for a program section

Path: [Main menu > Programs > Time program](#)

Select the desired program and section.

The section view gives access to all parameters of a program section. You can enter or modify the values.

<p>program 1 - Section number 1 🔒 12:40:17</p> <p>Duration <input type="text" value="02:00:00"/></p> <p>Course <input type="text" value="Ramp"/></p> <p>Functions on/off <input type="text" value="0000000000000000"/></p> <p>Number of repetitions <input type="text" value="0"/></p> <p>Start section for repetition <input type="text" value="1"/></p> <p>Temperature <input type="text" value="+70.000"/></p> <p>Tolerance band min. <input type="text" value="+0.0000"/></p> <p>Tolerance band max. <input type="text" value="+0.0000"/></p> <p>Fan <input type="text" value="+100.00"/></p> <p style="text-align: center;"> <input type="button" value="✕"/> <input type="button" value="✎"/> <input type="button" value="✓"/> </p>	<table border="1"> <tr><th colspan="2">Program name and section number</th></tr> <tr><td>Section duration</td><td></td></tr> <tr><td>Type of setpoint transition: ramp or step</td><td></td></tr> <tr><td>Operation lines</td><td></td></tr> <tr><td colspan="2">Repeating one or several sections within a program</td></tr> <tr><td>Temperature setpoint</td><td></td></tr> <tr><td colspan="2">Temperature tolerance range: minimum and maximum</td></tr> <tr><td>Fan speed</td><td></td></tr> <tr><td colspan="2"> </td></tr> </table>	Program name and section number		Section duration		Type of setpoint transition: ramp or step		Operation lines		Repeating one or several sections within a program		Temperature setpoint		Temperature tolerance range: minimum and maximum		Fan speed			
Program name and section number																			
Section duration																			
Type of setpoint transition: ramp or step																			
Operation lines																			
Repeating one or several sections within a program																			
Temperature setpoint																			
Temperature tolerance range: minimum and maximum																			
Fan speed																			

The setting and control ranges for the individual parameters are the same as for “Fixed value” operating mode (chap. 7).

9.7.1 Section duration

program 3 - Section number 1 🔒 10:58:07

Duration ⤴

Section view (partial view).

Select the field “Duration” indicating the time.

program 3 - Section number 2 🔒 11:14:19

Duration



: :

 (hh:mm:ss)

“Duration” entry menu.

Enter the desired section duration with the arrow keys and press the **Confirm** icon.

Setting range: 0 up to 99 hours 59 min 59 sec.

9.7.2 Set-point ramp and set-point step

You can define the type of temperature transitions for each individual program section.

“Ramp” mode: Gradual changes of temperature

The set-point of a given program section functions as the section’s start temperature. During the section’s duration, the set-point gradually passes to the set-point of the subsequent program section. The actual value follows the continually changing set-point.

If the last program section is in “ramp” mode and the setpoint shall change within this section, then you must program an additional section (with the shortest possible section duration) to provide the target temperature of the last program section. Otherwise, the setpoint would remain constant during the section’s duration.

Programming in the “ramp” mode allows all kinds of temperature transitions:

- Gradual changes of temperature
The setpoint changes its value gradually during the entered section duration. The actual value follows the continually moving set-point at any time.
- Program sections with constant temperature
The setpoints (initial values) of two subsequent program sections are identical; so, the temperature remains constant during the entire duration of the first program section.
- Sudden changes of temperature
Steps can be programmed in ramp mode as temperature changes (ramps) that occur during a very short interval. If the duration of this transitional program section is very short (minimum entry 1 sec), the temperature change will proceed rapidly within the minimum amount of time.

“Step” mode: Sudden changes of temperature

The set-point of any program section functions as the section’s target value. At the start of the program section, the unit heats up or cools down the chamber with the maximum speed to reach the entered value; and then it holds it for the remaining section time. Therefore, the set-point temperature remains constant for the section’s duration. These changes occur rapidly within the minimum amount of time (minimum entry: 1 second).

Programming in the “step” mode allows only two kinds of temperature transitions:

- Programming gradual changes of temperature (ramps) is impossible in the “step” mode
- Program sections with constant temperature
The setpoints (target values) of two subsequent program sections are identical; so, the temperature remains constant during the entire duration of the first program section.
- Sudden changes of temperature
The entered setpoint of the section is reached as fast as possible and then held constant for the remaining section duration.

Selecting the setting “Ramp” or “Step”

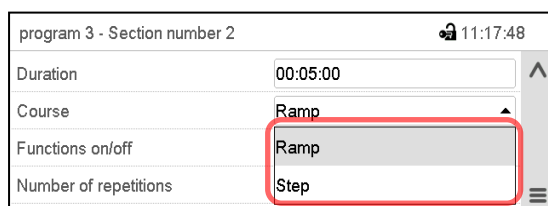

program 3 - Section number 2		🔒 11:17:48
Duration	00:05:00	▲
Course	Ramp	▲
Functions on/off	Ramp	
Number of repetitions	Step	☰

Section view (partial view).

In the field “Course” select the desired setting “Ramp” or “Step”.

“Ramp” and “Step” mode example (representation of a temperature course)

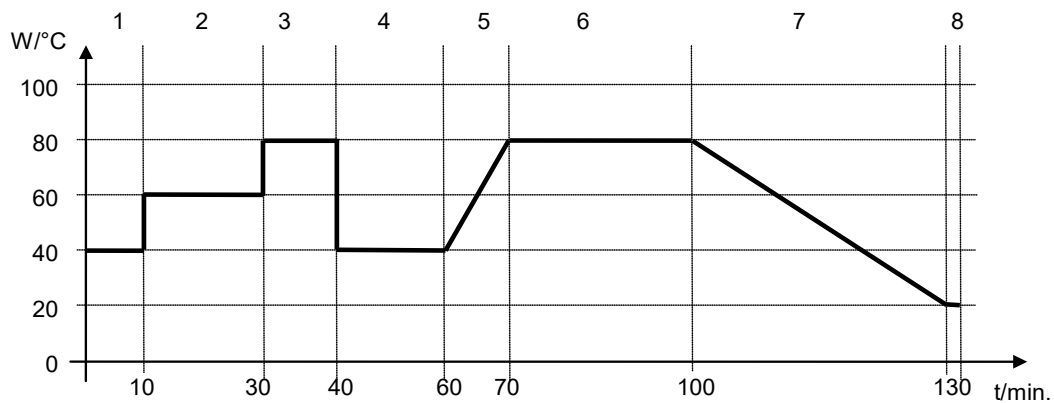

Corresponding program table

Section No.	Duration [hh:mm:ss]	Temperature [°C]	Fan [%]	Ramp or Step
1	00:10:00	40.0	xxxx	Step
2	00:20:00	60.0	xxxx	Step
3	00:10:00	80.0	xxxx	Step
4	00:20:00	40.0	xxxx	Step
5	00:10:00	40.0	xxxx	Ramp
6	00:30:00	80.0	xxxx	Ramp
7	00:30:00	80.0	xxxx	Ramp
8	00:00:01	20.0	xxxx	Ramp

9.7.3 Light commutation and special controller functions via operation lines

You can define the switching state of up to 16 operation lines (control contacts). They are used to activate / deactivate special controller functions.

- Operation line “Idle mode” activates / deactivates the operating mode “Idle mode” (chap. 5.4).
- Operation lines “Light level 1” and “Light level 2” serve to turn on/off the fluorescent tubes

The other operation lines are without function.

Use the setting “Functions on/off” to configure the operation lines.

program 1 - Section number 1 12:40:17

Duration	02:00:00
Course	Ramp
Functions on/off	0000000000000000
Number of repetitions	0
Start section for repetition	1
Temperature	+70.000
Tolerance band min.	+0.0000
Tolerance band max.	+0.0000
Fan	+100.00

Section view.

Select the field "Functions on/off".

Functions on/off 15:06:09

...	<input type="checkbox"/>
Idle mode	<input checked="" type="checkbox"/>
Light 1	<input type="checkbox"/>
Light 2	<input type="checkbox"/>
...	<input type="checkbox"/>
...	<input type="checkbox"/>
...	<input type="checkbox"/>
...	<input type="checkbox"/>
...	<input type="checkbox"/>
...	<input type="checkbox"/>

"Functions on/off" entry menu.

Mark / unmark the checkbox of the desired function to activate / deactivate it and press the **Confirm** icon.

The controller returns to the section view.

program 1 - Section number 1 12:32:12

Duration	02:00:00
Course	Ramp
Functions on/off	0000000000000010
Number of repetitions	0
Start section for repetition	1
Temperature	+70.000
Tolerance band min.	+0.0000
Tolerance band max.	+0.0000
Fan	+100.00

Section view indicating the operation lines.

Activated operation line: switching status "1" (On)

Deactivated operation line: switching status "0" (Off)

The operation lines count from right to left.

Example:

Activated operation line "Idle mode" = 0000000000000001

Deactivated operation line "Idle mode" = 0000000000000000

9.7.4 Setpoint entry

- Select the field "Temperature" and enter the desired temperature setpoint.
Setting range: -5 °C up to 70 °C
Confirm entry with **Confirm** icon. The controller returns to the section view.
- Select the field "Fan" and enter the desired fan speed setpoint.
Setting range: 40% up to 100% fan speed.
Confirm entry with **Confirm** icon. The controller returns to the section view.

9.7.5 Tolerance ranges

For temperature, you can specify a tolerance range for each program section with different values for the tolerance minimum and maximum. When the actual value exceeds the given threshold, the program is interrupted. This is indicated on the display (see below). When the actual temperature is situated again within the entered tolerance limits, the program automatically continues. Therefore, the duration of the program may be extended due to the programming of tolerances.



Programming of tolerances may extend program duration.

An entry of “-99999” for the tolerance minimum means “minus infinite” and an entry of “999999” for the tolerance maximum means “plus infinite”. Entry of these values will never lead to program interruption. The entry of “0” for the tolerance minimum and/or maximum deactivates the respective tolerance function.

When requesting rapid value transitions, we recommend not programming tolerance values in order to enable the maximum heating-up and cooling-down speed.

program 1 - Section number 1		🔒 12:40:17
Duration	02:00:00	
Course	Ramp	
Functions on/off	0000000000000000	
Number of repetitions	0	
Start section for repetition	1	
Temperature	+70.000	
Tolerance band min.	+0.0000	
Tolerance band max.	+0.0000	
Fan	+100.00	

Section view, showing the temperature tolerance band.

- Select the field “Tolerance band min” and enter the desired lower tolerance band value. Setting range: -99999 to 99999. Confirm entry with **Confirm** icon. The controller returns to the section view.
- Select the field “Tolerance band max” and enter the desired upper tolerance band value. Setting range: -99999 to 99999. Confirm entry with **Confirm** icon. The controller returns to the section view.

If one of those actual values for which a tolerance range has been specified lies outside this program tolerance range the whole program course is interrupted. During this program interruption time the controller equilibrates to the set-points of the current section.

The screen header indicates “Program pause (tolerance band)”. The program runtime indication flashes and does not proceed any further.

When the corresponding actual values is back within the entered program tolerance range, the program continues automatically.

9.7.6 Repeating one or several sections within a time program

You can repeat several subsequent sections together. It is not possible to define the start section the same time also as the target section, therefore you cannot repeat a single individual section.

Enter the desired number of repetitions in the field “Number of repetitions” and the number of the section to start the repetition cycle with in the field “Start section for repetition” To have sections repeated infinitely, enter the number of repetitions as “-1”.

The selected sections are repeated as many times as selected. Then the program continues.

program 1 - Section number 1 🔊 12:40:17

Duration

Course

Functions on/off

Number of repetitions

Start section for repetition

Temperature

Tolerance band min.

Tolerance band max.

Fan

Section view, showing the repetition function.

- Select the field “Number of repetitions” and enter the desired number of repetitions. Setting range: 1 to 99, and -1 for infinite. Confirm entry with **Confirm** icon. The controller returns to the section view.
- Select the field “Start section for repetition” and enter the section number, at which the repetition should start. Setting range: 1 up to the section before the currently selected section. Confirm entry with **Confirm** icon. The controller returns to the section view.

9.7.7 Saving the time program

program 1 - Section number 1 🔊 12:40:17

Duration

Course

Functions on/off

Number of repetitions

Start section for repetition

Temperature

Tolerance band min.

Tolerance band max.

Fan

Section view.

After the all desired values of the program section have been configured, press the **Confirm** icon to take over the programming.

The controller changes to the program view.



program 1 - Time program 🔊 11:17:41

No.	Duration [hh:mm:ss]	Temperature [°C]	---	Fan [%]	---
1	02:00:00	70.000	---	100.00	---
2	01:10:00	30.000	---	100.00	---
3	02:00:00	-5.0000	---	50.000	---
4	07:00:00	70.000	---	80.000	---
5	05:30:00	15.000	---	60.000	---

Program view.

Press the **Confirm** icon to take over the programming.

The controller changes to the Normal display.



To save the programming it is absolutely required to press the **Confirm** icon. Otherwise all settings will be lost! There is no confirmation prompt!

10. Week programs

The MB2 program controller permits programming week programs with real-time reference. It offers 5 week program places in total with up to 100 shift points for each week program.

Path: [Main menu](#) > [Programs](#) > [Week program](#)

10.1 Starting an existing week program

 In Normal display press the **Program start** icon to access the “Program start” menu.

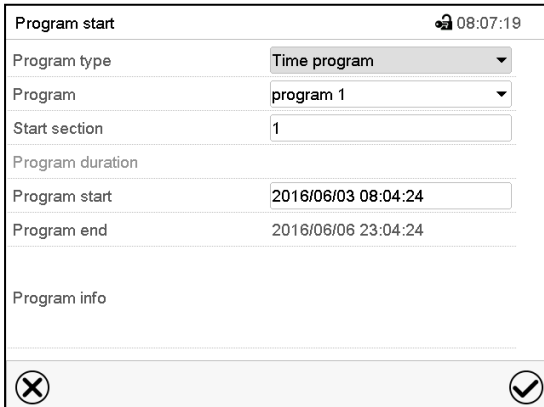

“Program start” menu.

- In the field “Program type” select the setting “Week program”.
- In the field “Program” select the desired program.
- There are no further settings available in the “Program start” menu for week programs, as they are needed only for time programs.

After completing the settings, press the **Confirm** icon to take over the entries and exit the menu. The program starts running.

If instead you press the **Close** icon to exit the menu without taking over the entries, the program will not start.

After starting the week program, the previously entered week program setpoints are active and will be equilibrated according to the current time.

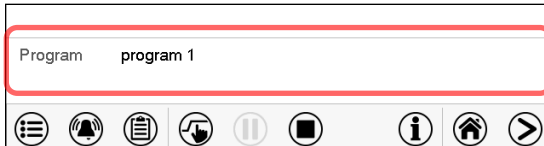

Information on the bottom of the screen indicates the currently running program.

10.2 Cancelling a running week program

 Press the **Program cancelling** icon to cancel the program.

A confirmation prompt is displayed. Press the **Confirm** icon to confirm that the program shall really be cancelled.

After confirming the message, the controller changes to Fixed value operation mode. Temperature and humidity will then equilibrate to the setpoints of Fixed value operation mode.

10.3 Creating a new week program

Path: [Main menu](#) > [Programs](#) > [Week program](#)

Week program	
No.	Program name
26	program 1
27	program 2
28	< empty >
29	< empty >
30	< empty >

“Week program” menu:
overview of the existing programs.
Select an empty program place.



Week program	
No.	Program name
26	program 1
27	program 2
28	< empty >
29	< empty >
30	< empty >

program 1	
Program name	program1
Program info	
Course	Ramp



Enter the program name and, if desired, additional program information in the corresponding fields.

Select the set-point course “Ramp” or “Step” (chap. 10.6.1).

Press the **Confirm** icon.

The program view opens.

program 1 - Week program						
No.	Weekday	Time [hh:mm:ss]	Temperature [°C]	...	Fan [%]	
1	No day	00:00:01	70.000	...	100.00	

Program view.

For the first section no weekday is specified. Therefore, the section is first marked in red and cannot be saved.

10.4 Program editor: program management

Path: [Main menu](#) > [Programs](#) > [Week program](#)

No.	Program name
26	program 1
27	program 2
28	< empty >
29	< empty >
30	< empty >

“Week program” menu:
overview of the existing programs.
Select an existing program (example: program 1).



No.	Weekday	Time [hh:mm:ss]	Temperature [°C]	...	Fan [%]
1	Daily	06:15:00	20.000	---	100.00
2	Monday	06:00:00	70.000	---	100.00

Program view (example: program 1).
If a new program has been created, there is just one program section.

There are the following options:

- ① Select a program section to open the section editor (chap. 10.5)
- ② Press the **Edit** icon to open the program editor

program 1 - Week program	
Edit program	
Change program name	
Copy program	
Delete program	
Create new section	

Program editor: “Edit program” menu.
Select the desired function and press the **Confirm** icon.

The program editor offers following options:

- Change program name. This menu also offers to configure the ramp / step mode setting (chap. 10.6.1).
- Copy program
- Replace program: Replacing a new or an existing program with the copied program. This menu point is visible only after a section has been copied.
- Delete program
- Create new section

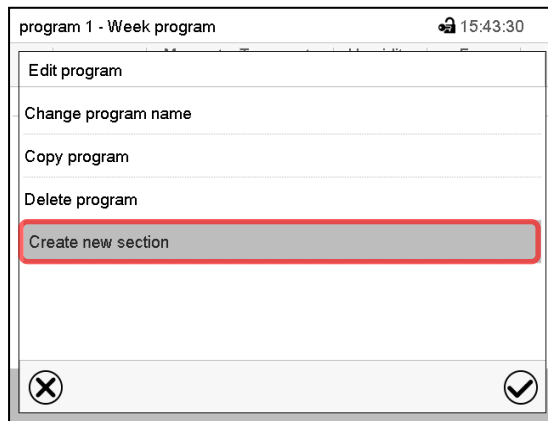

To add a new section, select “Create new section” and press the **Confirm** icon.

The program view opens.

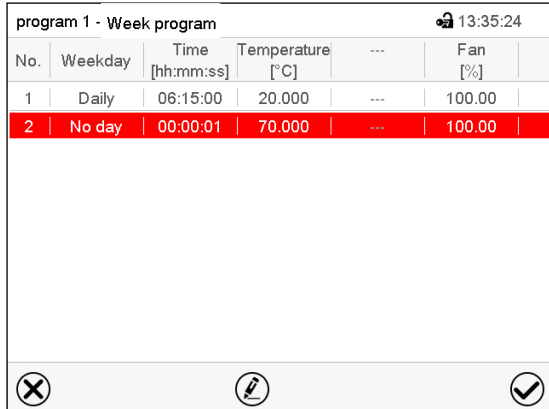

No.	Weekday	Time [hh:mm:ss]	Temperature [°C]	---	Fan [%]
1	Daily	06:15:00	20.000	---	100.00
2	No day	00:00:01	70.000	---	100.00

Program view.

With a new section no weekday is specified. Therefore, the section is first marked in red and cannot be saved.

A new section is always added at the very bottom (example: section 3). When the section start is specified the sections are automatically arranged in the correct chronological order.

10.4.1 Deleting a week program

Path: [Main menu](#) > [Programs](#) > [Week program](#)

In the “Week program” menu select the program to be deleted. The program view opens.



In the **program view** press the **Edit** icon to open the program editor



In the **program editor** select “Delete program” and press the **Confirm** icon.

The program is deleted. The controller returns to the program view.

10.5 Section editor: section management

Path: [Main menu](#) > [Programs](#) > [Week program](#)

Select the desired program.

No.	Weekday	Time [hh:mm:ss]	Temperature [°C]	...	Fan [%]
1	Daily	06:15:00	20.000	...	100.00
2	Monday	06:00:00	70.000	...	100.00

Program view.

Select the desired program section
(example: section 1)



Programm 1 - Section number 1	
Weekday	Monday
Time	06:15:00
Temperature	+20.000
Fan	+100.00
Functions on/off	0000000000000000

Section view (example: section 1).

There are the following options:

- ① Select a parameter to enter or modify the according value (chap. 10.6)
- ② Press the **Edit** icon to open the program editor



program 1 - Section number 1	
Edit section	
Copy section	
Delete section	
Create new section	

Section editor: "Edit section" menu

Select the desired function and press the **Confirm** icon.

The section editor offers following options:

- Copy section
- Replace section: Replacing an existing section with the copied section. This menu point is visible only after a section has been copied.
- Insert section: Adding the copied section. This menu point is visible only after a section has been copied.
- Delete section
- Create new section

10.5.1 Add a new program section

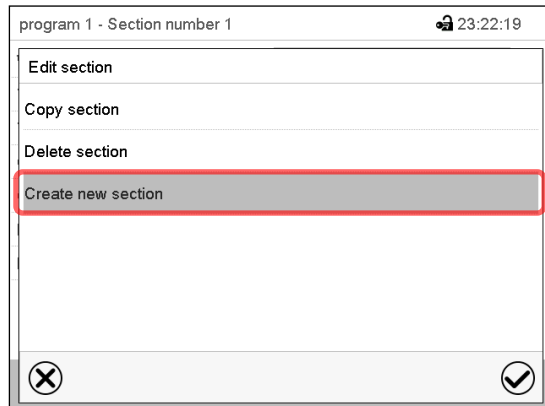

Section editor: “Edit section” menu.

Select “Create new section” and press the **Confirm** icon.

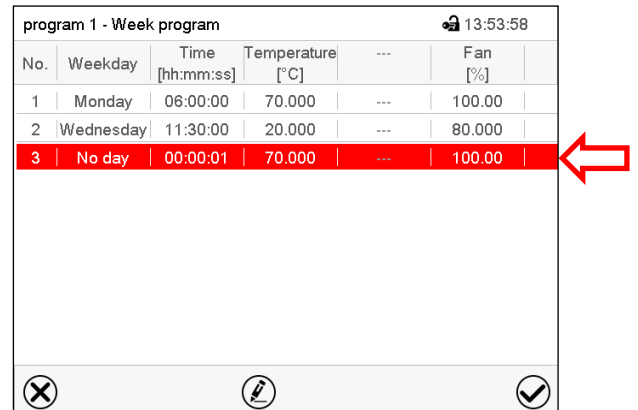

Program view.

With a new section no weekday is specified. Therefore, the section is first marked in red and cannot be saved.

A new section is always added at the very bottom (example: section 3). When the section start is specified the sections are automatically arranged in the correct chronological order.

10.5.2 Copy and insert or replace a program section

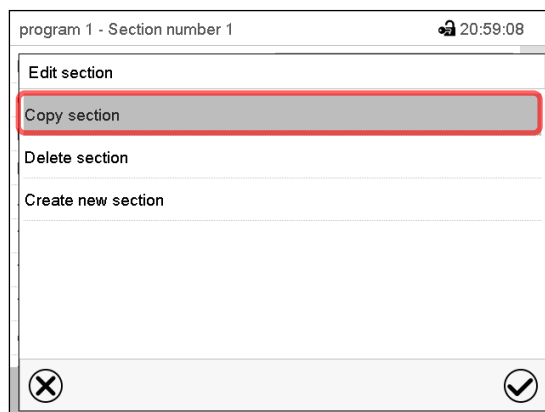

Section editor: “Edit section” menu

Select “Copy section” and press the **Confirm** icon.

The current section (example: section 1) is copied.

The controller returns to the program view.

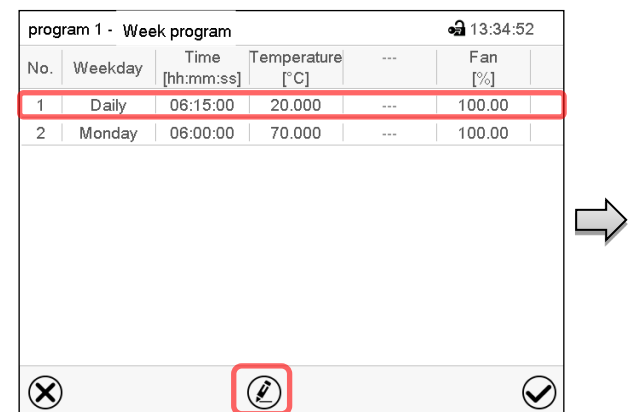

Program view

Select the section to be replaced or before or after which the copied section shall be inserted (example: section 1).

Press the **Confirm** icon

The controller returns to the section editor

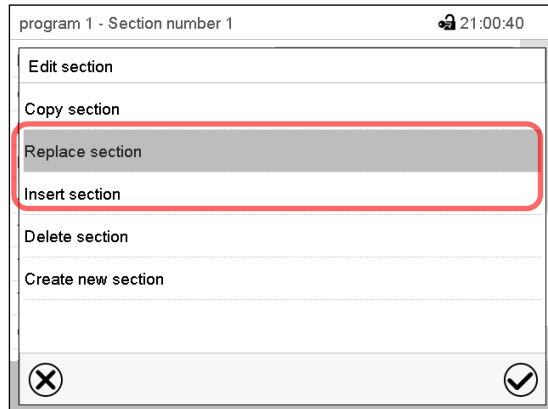

Section editor: “Edit section” menu

Select “Replace section” to replace the selected section with the copied section

or

Select “Insert section” to additionally add the copied section.

Press the **Confirm** icon.

If you selected “Insert section” the sections are automatically arranged in the correct chronological order.

10.5.3 Deleting a program section

In the **program view** select the program section to be deleted. The section view opens.



In the **section view** press the **Edit** icon to open the section editor



In the **section editor** select “Delete section” and press the **Confirm** icon.

The section is deleted. The controller returns to the section view.

10.6 Value entry for a program section

Path: [Main menu > Programs > Week program](#)

Select the desired program and section.

The setting and control ranges for the individual parameters are the same as for “Fixed value” operating mode (chap. 7).

10.6.1 Set-point ramp and set-point step modes

The explanation of the settings “Ramp” or “Step” is given in chap. 9.7.2.

You can define the type of temperature transitions for the entire week program.

Select the desired program and press the **Edit** icon to open the program editor. In the program editor select the “Change program name” function and press the **Confirm** icon.

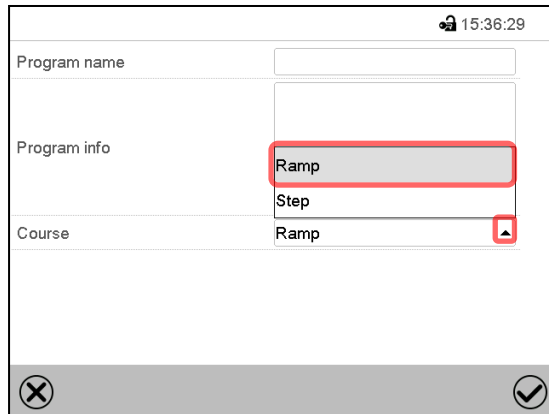

“Change program name” menu.

In the field “Course” select the desired setting “Ramp” or “Step” and press the **Confirm** icon.

10.6.2 Weekday

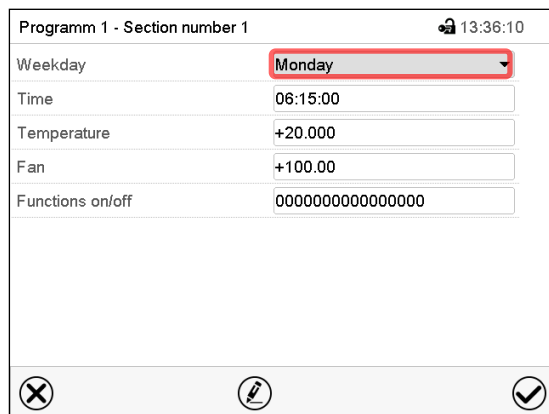

In the field “Weekday” select the desired weekday.

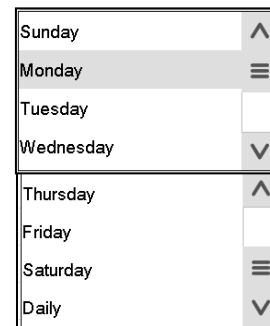

With “Daily” selected, this section will run every day at the same time.

Section view.

10.6.3 Start time

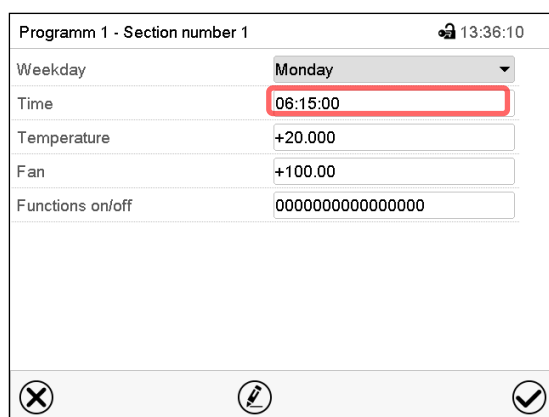

Section view.

Select the field “Moment”.

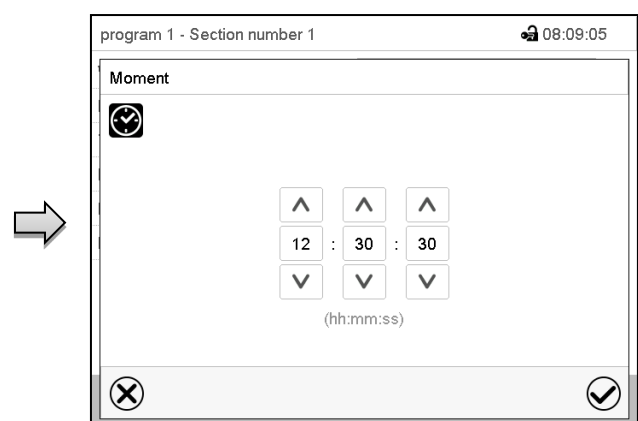

Entry menu “Moment”.

Select with the arrow keys the desired start moment of the section and press the **Confirm** icon.

10.6.4 Setpoint entry

- Select the field “Temperature” and enter the desired temperature setpoint.
Setting range: -5 °C up to 70 °C
Confirm entry with **Confirm** icon. The controller returns to the section view.
- Select the field “Fan” and enter the desired fan speed setpoint.
Setting range: 40% up to 100% fan speed.
Confirm entry with **Confirm** icon. The controller returns to the section view.

10.6.5 Light commutation and special controller functions via operation lines

You can define the switching state of up to 16 operation lines (control contacts). They are used to activate / deactivate special controller functions.

- Operation line “Idle mode” activates / deactivates the operating mode “Idle mode” (chap. 5.4).
- Operation lines “Light level 1” and “Light level 2” serve to turn on/off the fluorescent tubes

The other operation lines are without function.

Select the desired program and section. You can set the operation lines in the “Functions on/off” field.

For details please refer to chap. 9.7.3.

11. Notification and alarm functions

11.1 Notification and alarm messages overview

11.1.1 Notifications

Notifications are indicated by **information icons** displayed in the screen header in Normal display

An information icon serves as an indication of a certain condition.



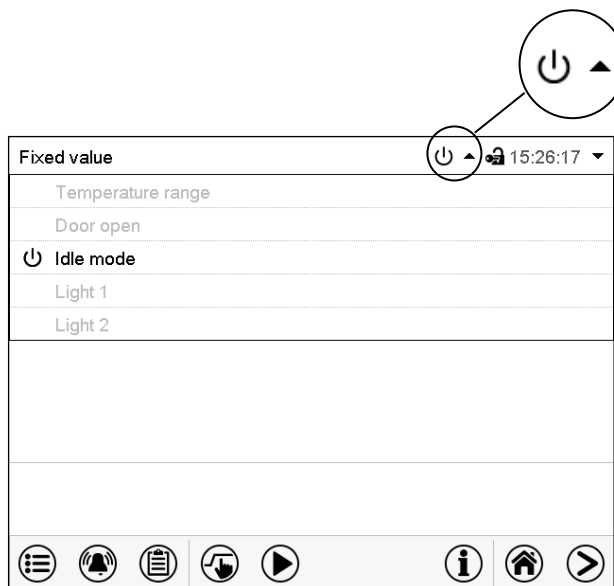

If this condition persists, in some cases an alarm will be triggered after a fix or configurable interval. As long as the condition persists, the information icon therefore continues to be displayed also in state of alarm. If during alarm the conditions ends, e.g., if during a tolerance range alarm the actual value returns to within the tolerance range, the information icon disappears, whereas the alarm will continue until manual acknowledgement.

Press the flash icon next to the information icon to access the corresponding text information.



Normal display showing the text information.

The currently valid information texts are highlighted in black (example: "Idle mode")

Condition	Information icon	Text information	Start after condition occurred
The controller is in Idle mode (chap. 5.4).		"Idle mode"	immediately
The current actual temperature value is outside the tolerance range (chap. 11.4)		"Temperature range"	immediately
Chamber door open		"Door open"	immediately
Light level 1 (40% illumination) turned on (operation line "Light level 1" activated)		"Light level 1"	immediately
Light level 2 (60 % illumination) turned on (operation line "Light level 2" activated)		"Light level 2"	immediately

Notifications are not shown in the event list.

11.1.2 Alarm messages

Condition	Alarm message	Start after condition occurred	Zero-voltage relay alarm output (option)
The current actual temperature value is outside the tolerance range (chap. 11.4)	“Temperature range”	after configurable time (chap. 11.4)	time as alarm start
Open chamber door	“Door open	after 5 minutes	----
Power failure	---	----	immediately
Exceeded setpoint of the safety controller class 3.1	“Safety controller	immediately	----
Exceeded maximum or minimum temperature (option temperature safety device class 3.3)	“Temp. safety device	immediately	----
Temperature sensor defective	e.g. “----“ or “<-<-“ or “->->”	immediately	----
Safety controller temperature sensor defective	Safety controller sensor	immediately	----

Alarm messages are displayed in the list of active alarms until acknowledging them. They are also shown in the event list.

11.2 State of alarm

1. Visual indications in Normal display: alarm message, screen header flashing in red color
2. Audible alert, if the buzzer is enabled (chap. 11.5).
3. Switching the zero-voltage relay alarm output (option, chap. 19.5) to transmit the alarm e.g., to a central monitoring system.

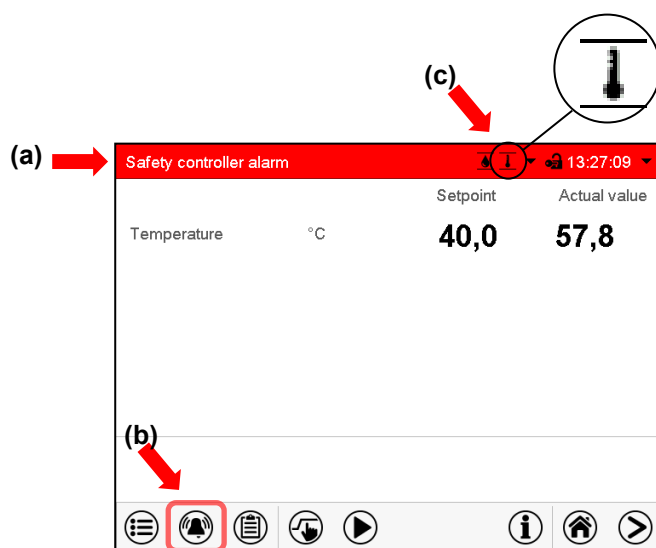

Normal display in state of alarm (example).

- (a) Screen header flashing in red color and showing the alarm message
- (b) **Alarm** icon on the bottom of the screen: change to the list of active alarms and alarm acknowledgement
- (c) If applicable, information icon in the screen header. Indication of a certain condition

11.3 Resetting an alarm, list of active alarms

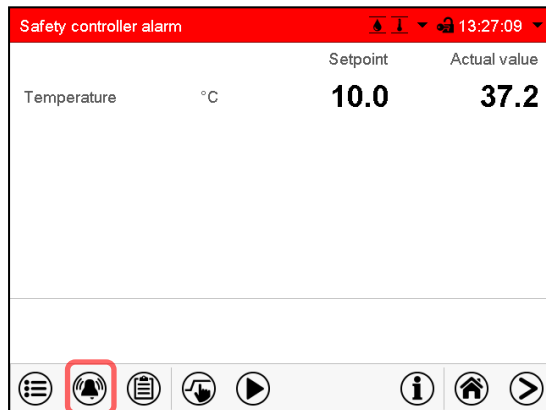

Normal display in state of alarm (example).

Press the **Alarm** icon

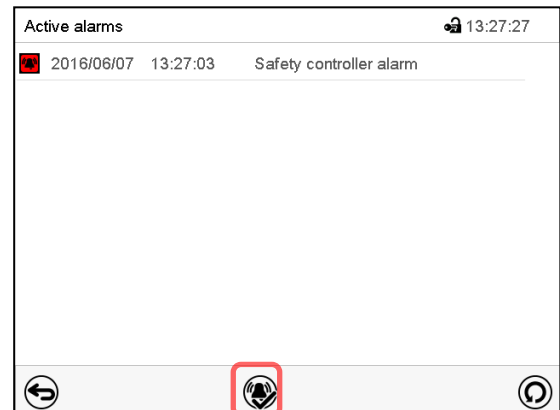

List of active alarms.

Press the **Reset alarm** icon.

Pressing the **Reset alarm** icon mutes the buzzer for all active alarms. The icon then disappears.

- Acknowledging while the alarm condition persists: Only the buzzer turns off. The visual alarm indication remains on the controller display. The alarm remains in the list of active alarms.
When the alarm condition has ended, the visual alarm indication is automatically cleared. The alarm is then no longer in the list of active alarms.
- Acknowledging after the alarm condition has ended: The buzzer and the visual alarm indication are reset together. The alarm is then no longer in the list of active alarms.
- The zero-voltage relay alarm output resets together with the alarm.

11.4 Tolerance range settings

In this menu you can set the deviation between the actual value and setpoint which shall cause a tolerance range alarm.

This function only activates after the set-point has been reached once.

Path: [Main menu](#) > [Settings](#) > [Various](#)

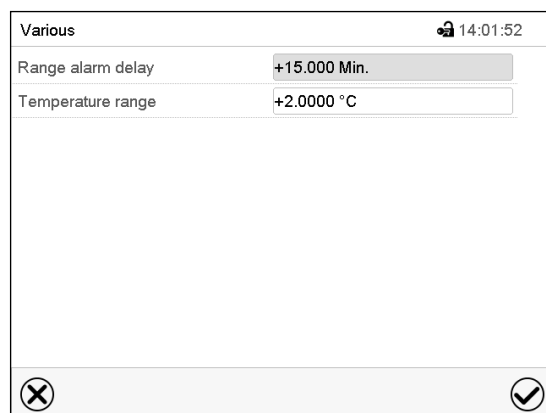

Submenu "Various".

- Select the field "Range alarm delay" and enter the time in minutes, after which the range alarm shall be triggered. Setting range: 15 min to 120 min. Confirm entry with **Confirm** icon.
- Select the field "Temperature range" and enter the desired value for the temperature range. Setting range: 2 °C to 20 °C. Confirm entry with **Confirm** icon.

•

After completing the settings, press the **Confirm** icon to take over the entries and exit the menu, **or** press the **Close** icon to exit the menu without taking over the entries.

If there are actual values outside the tolerance range the following information icons for the corresponding parameter are displayed:

Icon	Signification	Information
	"Temperature range"	The temperature value is outside the tolerance range

If the condition persists, an alarm is triggered after the configured interval ("range alarm delay"). It is visually indicated in Normal display. If the alarm buzzer is activated (chap. 11.5) there is an audible alert. The zero-voltage relay alarm output (option, chap. 19.5) switches to transmit the alarm. The alarm is shown in the list of active alarms (chap. 11.3).

11.5 Activating / deactivating the audible alarm (alarm buzzer)

Path: [Main menu](#) > [Settings](#) > [Chamber](#)

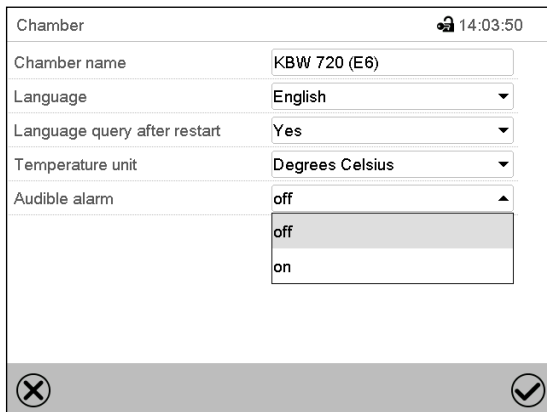

The screenshot shows a 'Chamber' submenu with the following settings:

- Chamber name: KBW 720 (E6)
- Language: English
- Language query after restart: Yes
- Temperature unit: Degrees Celsius
- Audible alarm: off

The 'Audible alarm' dropdown menu is open, showing 'off' and 'on' options. The 'off' option is currently selected. At the bottom of the screen, there are 'Close' (X) and 'Confirm' (checkmark) icons.

"Chamber" submenu (example).

In the field "Audible alarm" select the desired setting "off" or "on" and press the **Confirm** icon.

12. Temperature safety devices

12.1 Over temperature protective device (class 1)

The chamber is equipped with an internal temperature safety device, class 1 acc. to DIN 12880:2007. It serves to protect the chamber and prevents dangerous conditions caused by major defects.

If a temperature of approx. 110 °C / 230 °F is reached, the over temperature protective device permanently turns off the chamber. The user cannot restart the device again. The protective cut-off device is located internally. Only a service specialist can replace it. Therefore, please contact an authorized service provider or BINDER Service.

12.2 Overtemperature safety controller class 3.1

The chambers are regularly equipped with an electronic overtemperature safety controller (temperature safety device class 3.1 according to DIN 12880:2007). The safety controller is functionally and electrically independent of the temperature control system. If an error occurs, it performs a regulatory function.



With option temperature safety device class 3.3 (chap. 12.3), the safety controller is **not** used. It must be set to the maximum limit value (70 °C / 158 °F).

Please observe the regulations applicable to your country (for Germany: DGUV guidelines 213-850 on safe working in laboratories, issued by the employers' liability insurance association).

The overtemperature safety controller serves to protect the chamber, its environment and the contents from exceeding the maximum permissible temperature. In the case of an error, it limits the temperature inside the chamber to the entered safety controller set-point. This condition (state of alarm) is indicated visually and additionally with an audible alert if the buzzer is enabled (chap. 11.5). The alarm persists until the chamber cools down below the configured safety controller setpoint.



Check the setting regularly and adjust it following changes of the set-point or charge.



The safety controller only activates after the set-point has been reached once.

12.2.1 Safety controller modes

You can select between "Limit (absolute)" and "Offset (relative)" safety controller mode

- **Limit:** Absolute maximum permitted temperature value

This setting offers high safety as a defined temperature limit will not be exceeded. It is important to adapt the safety controller set-point after each modification of the temperature set-point. Otherwise, the limit could be too high to ensure efficient protection, or, in the opposite case, it could prevent the controller from reaching an entered set-point outside the limit range.

- **Offset:** Maximum overtemperature above any active temperature set point. The maximum temperature changes internally and automatically with every set-point change.

This setting is recommended for program operation. It is important to check the safety controller set-point and safety controller mode occasionally, as it does not offer a fix, independent limit temperature value, which would never be exceeded.

Example: Desired temperature value: 40 °C, desired safety controller value: 45 °C.

Possible settings for this example:

Temperature set point	Safety controller mode	Safety controller set-point
40 °C	Limit (absolute)	45 °C
	Offset (relative)	5 °C

12.2.2 Setting the safety controller



Press the **Setpoint setting** icon to access the “Setpoint” setting menu from Normal display.

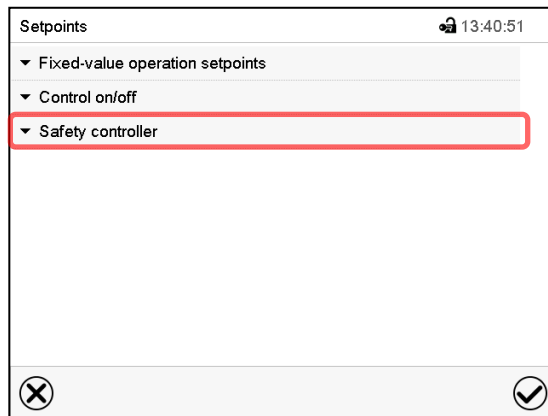

“Setpoints” menu.

Select the field “Safety controller” to access the settings.

- In the field “Mode” select the desired setting “Limit” or “Offset”.

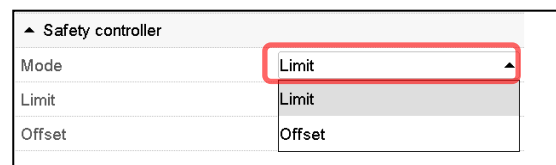

- Select the corresponding field “Limit” or “Offset” according to the selected mode and enter the desired safety controller setpoint. Confirm entry with **Confirm** icon.



Regularly check the safety controller setting for set-point type “Limit” or “Offset”

- in Fixed value operating mode according to the entered set-point temperature value
- in program mode according to the highest temperature value of the selected temperature program

Set the safety controller set-point by approx. 2 °C to 5 °C above the desired temperature set-point.

After completing the settings, press the **Confirm** icon to take over the entries and exit the menu, **or** press the **Close** icon to exit the menu without taking over the entries.

12.2.3 Message and measures in the state of alarm

The state of alarm is indicated visually in Normal display by the alarm message “Safety controller alarm” and the screen header flashing in red color. If the buzzer is enabled (chap. 11.5) there is an additional audible alert (chap. 11.2). The alarm remains active until it is acknowledged on the controller and the inner temperature falls below the set safety controller setpoint. Then the heating is released again.

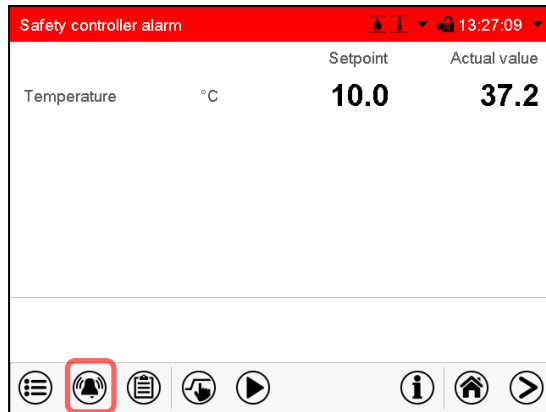

Normal display with safety controller alarm.

Press the **Alarm** icon

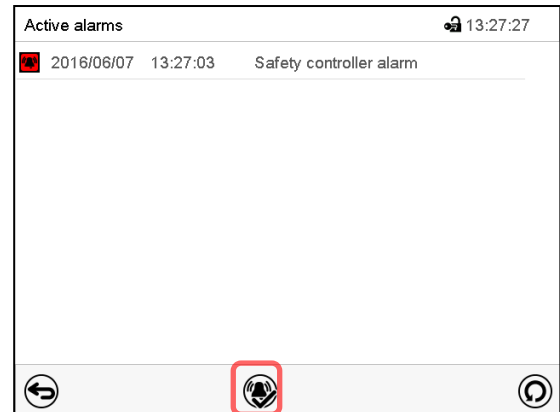

List of active alarms.

Press the **Reset alarm** icon.

12.2.4 Function check

Check the safety controller at appropriate intervals for its functionality. It is recommended that the authorized operating personnel should perform such a check, e.g., before starting a longer work procedure.

12.3 Temperature safety device class 3.3 (option)

With the option over/under temperature protective device (temperature safety device class 3.3 acc. to DIN 12880:2007) the chamber is equipped with two additional safety devices (class 3.1 and class 3.2). The combination of the safety devices is regarded as a safety device class 3.3.

The temperature safety device, class 3.3, serves to protect the chamber, its environment and the contents from exceeding the maximum permissible temperature. Please observe the regulations applicable to your country (for Germany: DGUV guidelines 213-850 on safe working in laboratories, issued by the employers' liability insurance association).

With **safety device class 3.1** a maximum value for the temperature is set that the chamber will not exceed due to the regulatory function of the safety device class 3.1. This protection against excessively high temperatures can, for example, serve to protect the chamber, its environment and the material under treatment from excess temperatures.

With **safety device class 3.2** a minimum value for the temperature is set that the chamber will not fall below due to the regulatory function of the safety device class 3.2. This protection against excessively low temperatures can, for example, serve to protect sensitive loads from under cooling.

Both safety devices are functionally and electrically independent of the temperature control system. If an error occurs, they perform regulatory function.

Safety devices class 3.1 (8) and class 3.2 (9) are located in the left lateral control panel.



With option temperature safety device class 3.3, the safety controller (chap. 12.2) must be set to the maximum limit value (70 °C / 158 °F).

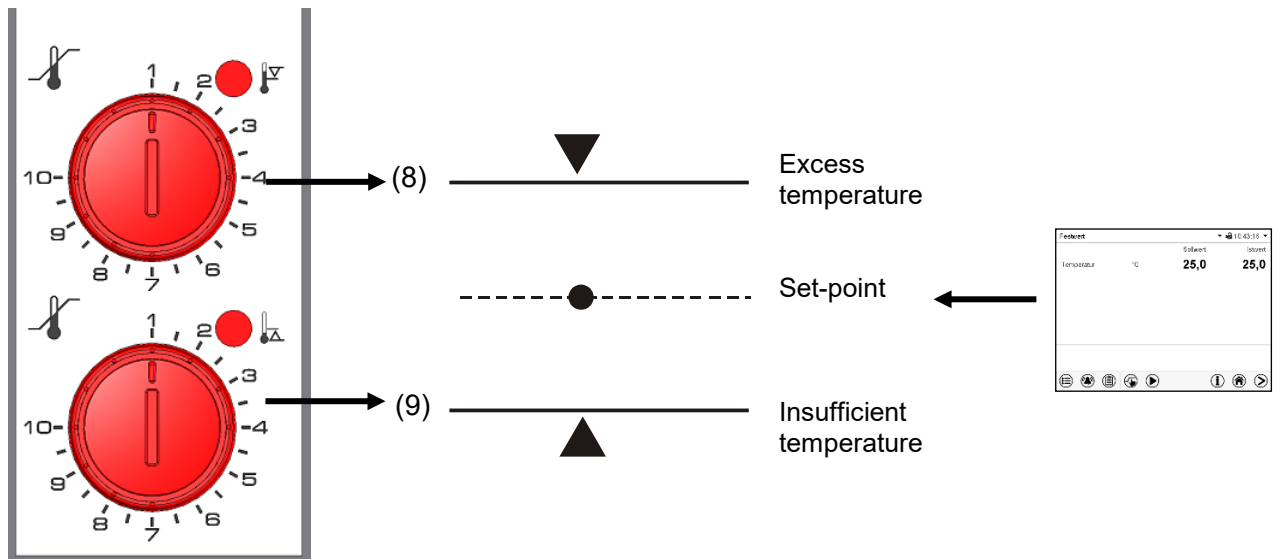
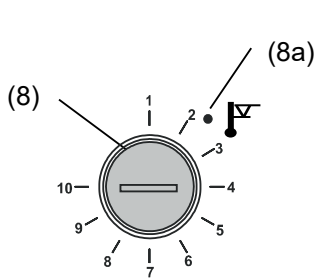

Figure 11: Temperature safety device class 3.3

12.3.1 Temperature safety device class 3.1



If you turn the control knob (8) to its end-stop (position 10), the safety device class 3.1 protects the appliance. If you set the temperature a little above the set-point, it protects the charging material.

If the safety device class 3.1 has taken over control, identifiable by the red alarm lamp (8a) lighting up, the message “Temp. safety device” on the controller will be displayed and the buzzer will sound, then proceed as follows:

- Reset the buzzer by pressing the **Reset alarm** icon on the controller
- Disconnect the chamber from the power supply
- Have an expert examine and rectify the cause of the fault.
- Start up the chamber again

Setting:

To check the response temperature of the safety device class 3.1, turn on the chamber and set the desired set point at the temperature controller.

The sections of the scale from 1 to 10 correspond to the temperature range from 0 °C / 32 °F to 120 °C / 248 °F and serve as a setting aid.

- Turn the control knob (8) of the safety device using a coin to its end-stop (position 10) (chamber protection).
- When the set point is reached, turn back the control knob (8) until its trip point (turn it counter-clockwise).
- The trip point is identifiable by the red alarm lamp (8a), the message “Temp. safety device” on the controller display, and the buzzer sounds. Reset the buzzer with the **Reset alarm** icon on the controller.
- The optimum setting for the safety device is obtained by turning the control knob clockwise by approximately two scale divisions, which shuts off the red alarm lamp (8a).

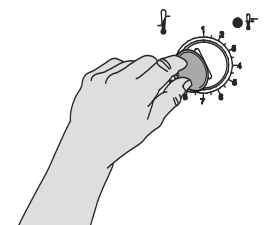

Figure 12: Setting safety device class 3.1



Check the setting regularly and adjust it following changes of the set-point or charge.

Function check:

Check the temperature safety device class 3.1 at appropriate intervals for its functionality. It is recommended that the authorized operating personnel should perform such a check, e.g., before starting a longer work procedure.

12.3.2 Temperature safety device class 3.2

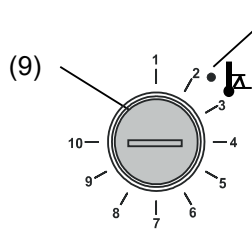

(9a) The safety device class 3.2 is equivalently set to a minimum temperature the chamber will not fall below. This protection against prohibited low temperatures can, for example, serve to protect sensitive cultures from cooling down too much.

If the control knob (9) is turned to its minimum (position 1), the safety device class 3.2 has no effect. If it is set to a temperature somewhat lower than that selected by means of the controller, it functions as a protective device for the material under treatment.

If the temperature safety device class 3.2 has assumed regulation, identifiable by the red alarm lamp (9a) lighting up, the message “Temp. safety device” on the controller display, and the buzzer sounds, please proceed as follows:

- Reset the buzzer with the **Reset alarm** icon on the controller.
- Disconnect the chamber from the power supply.
- Have an expert examine and rectify the cause of the fault.
- Start up the chamber again

Setting:

To check the response temperature of the safety device class 3.2, put the chamber into operation and set the desired set point at the temperature controller.

The sections of the scale from 1 to 10 correspond to the temperature range from $-40\text{ °C} / -40\text{ °F}$ to $+160\text{ °C} / 320\text{ °F}$ and serves as a setting aid.

- Turn the control knob (9) of the safety device by means of a coin to position 1 (thermostat without effect).
- When the set point is reached, reset the safety device to its trip point (turn it clockwise).
- The trip point is identifiable by the red alarm lamp (9a), the message “Temp. safety device” on the controller display, and the buzzer sounds. Reset the buzzer with the **Reset alarm** icon on the controller.
- The optimum setting for the safety device is obtained by turning the control knob counter-clockwise by approximately two scale divisions, which shuts off the red alarm lamp (9a).

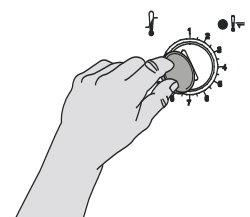

Figure 13: Setting safety device class 3.2



Check the setting regularly and adjust it following changes of set-point or charge.

Function check:

Check the temperature safety device class 3.2 at appropriate intervals for its functionality. It is recommended that the authorized operating personnel should perform such a check, e.g., before starting a longer work procedure.

13. User management

13.1 Authorization levels and password protection

The available functions depend on the current authorization level “Master”, “Service”, “Admin” or “User”.

The authorization levels are hierarchical: Every authorization includes all functions of the next lower level.

“Master” authorization level

- Highest authorization level, only for developers
- Extensive authorization for controller operation and configuration, outputs/inputs, alarm settings, parameter sets and operating ring display
- All passwords can be changed in the “log out” submenu (chap. 13.3).

“Service” authorization level

- Authorization level only for BINDER service
- Extensive authorization for controller operation and configuration, access to service data
- The passwords for “Service”, “Admin” and “User” authorization levels can be changed in the “log out” submenu (chap. 13.3).

“Admin” authorization level

- Expert authorization level, for the administrator
- Authorization for controller configuration and network settings and for operating those controller functions required for operating the chamber. Restricted access to service data.
- Password (factory setting): “2”.
- The passwords for “Admin” and “User” authorization levels can be changed in the “log out” submenu (chap. 13.3).

“User” authorization level

- Standard authorization level for the chamber operator
- Authorization for operating the controller functions required for operating the chamber.
- No authorization for controller configuration and network settings. The “Settings” and “Service” submenus of the main menu are not available.
- Password (factory setting): “1”
- The password for the “User” authorization level can be changed in the “log out” submenu (chap. 13.3).

As soon as a password has been assigned for an authorization level, the access to this level and the related controller functions are only available after log-in with the appropriate password.

If for an authorization level no password is assigned, the related controller functions of this level are available for every user without login.

If passwords have been assigned for all authorization levels, access to the controller functions is locked without login.

Operation after user login

At user login, the authorization level is selected and confirmed by entering the respective password.

Following user login, controller operation is available, recognizable by the open-lock icon in the header. The available controller functions correspond to the user's authorization level.

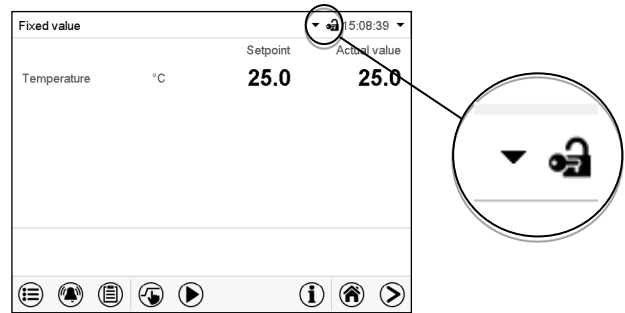

Password protection activated for all levels: operation without user login is locked

If passwords have been assigned for all authorization levels, the controller is locked without registration of a user.

As long as no user is registered, controller operation is locked, recognizable at the closed-lock icon in the header. This requires that the user management has been activated by the assignment of passwords for the individual authorization levels.

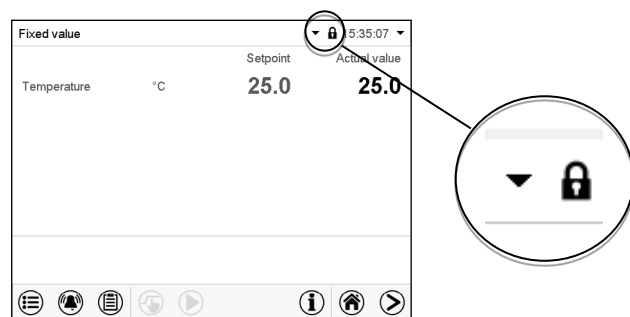

Password protection for at least one level deactivated: operation without user login is possible

If passwords have not been assigned for all authorization levels, after turning on the chamber there are those controller functions available, which correspond to the highest authorization level without password protection.

No lock icon is shown in the display header.

User login is neither required nor possible.

To activate the password protection and user login, perform new password assignment (chap. 13.5.3).

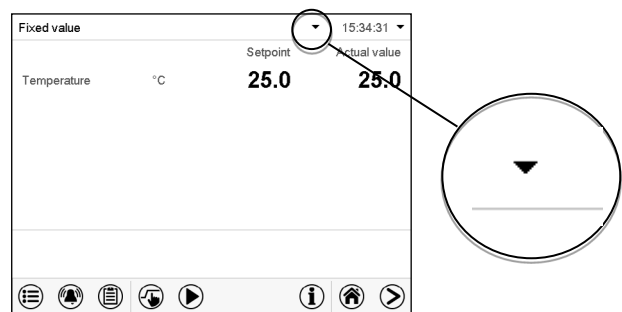



Information window

To check the authorization level of the user currently logged-in, select in Normal display the arrow far right in the display header.

Fixed value		Setpoint	Actual value
Temperature	°C	40.0	40.0

The information window shows date and time, the controller's free memory space and under "Authorization" the authorization level of the current user.

If passwords have been assigned for all authorization levels, a user without login (password entry) has no authorization. There are only viewing functions available.

Fixed value			
 Tuesday, 2016/05/24	 14:32:10		
 Authorization:	 Free storage: 98%		

Display when all authorization levels are password protected and no user has logged in:

No authorization level is displayed.

If passwords have been assigned only for some of the authorization levels, a user without login (password entry) has access to the functions of the highest authorization level without password protection.





Fixed value			
 Tuesday, 2016/05/24	 14:29:26		
 Authorization: Admin	 Free storage: 98%		

Display when only some of the authorization levels are password protected (example: no protection for the "User" and "Admin" levels) and no user has logged in:

The user's effective authorization (due to lack of password protection) is shown.

Example: user with "Admin" authorization.

If passwords have been assigned for some or all of the authorization levels, user login (password entry) provides the authorization for the corresponding password-protected level.

Fixed value			
 Tuesday, 2016/05/24	 14:29:26		
 Authorization: Admin	 Free storage: 98%		

Display when at least some of the authorization levels are password protected and a user has logged in.

The user's authorization (by password entry) is shown.

Example: user with "Admin" authorization.

13.2 Log in

Path: **Main menu > User > Log in**

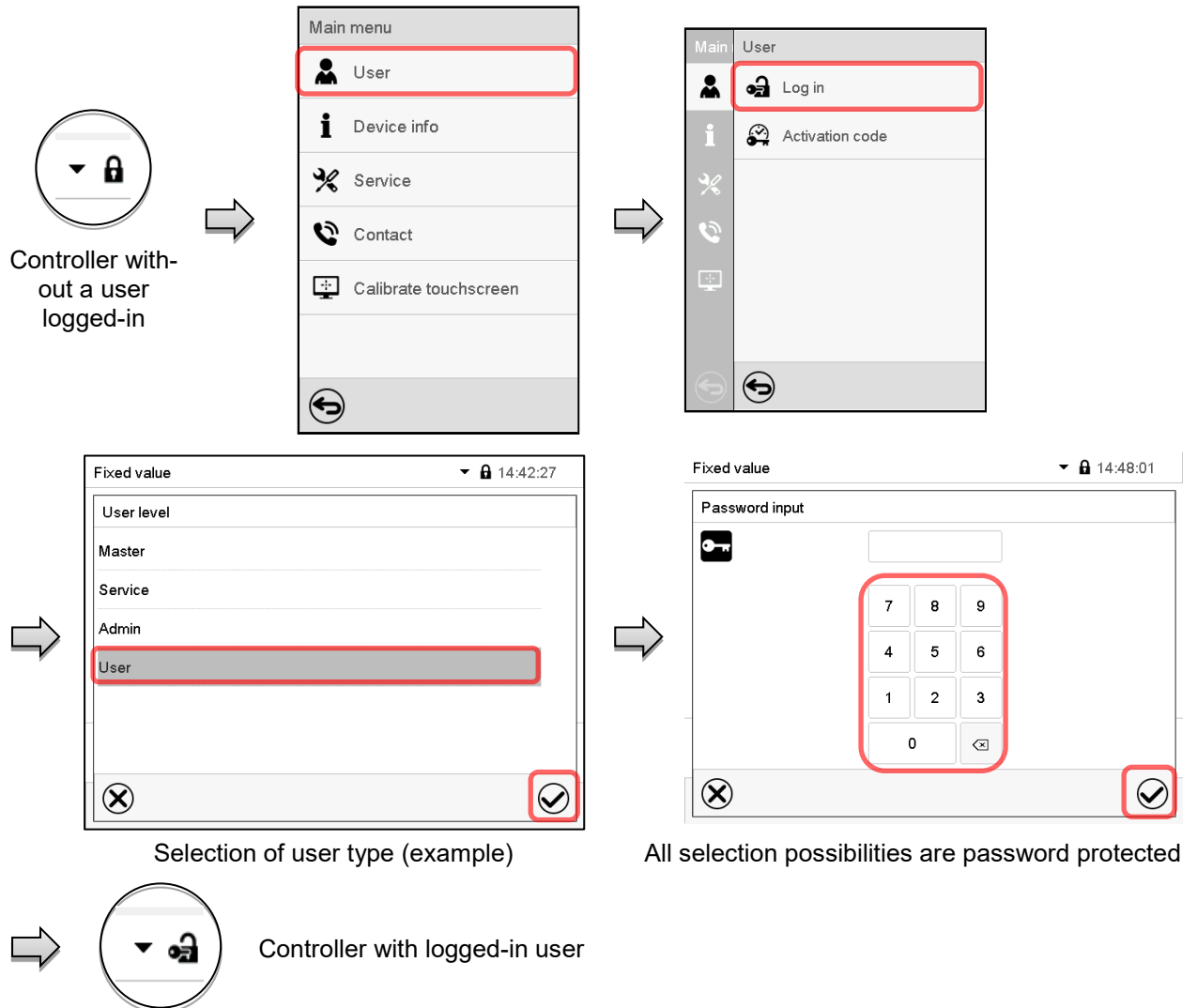

After completing the settings, press the **Confirm** icon to take over the entries and exit the menu, **or** press the **Close** icon to exit the menu without taking over the entries.

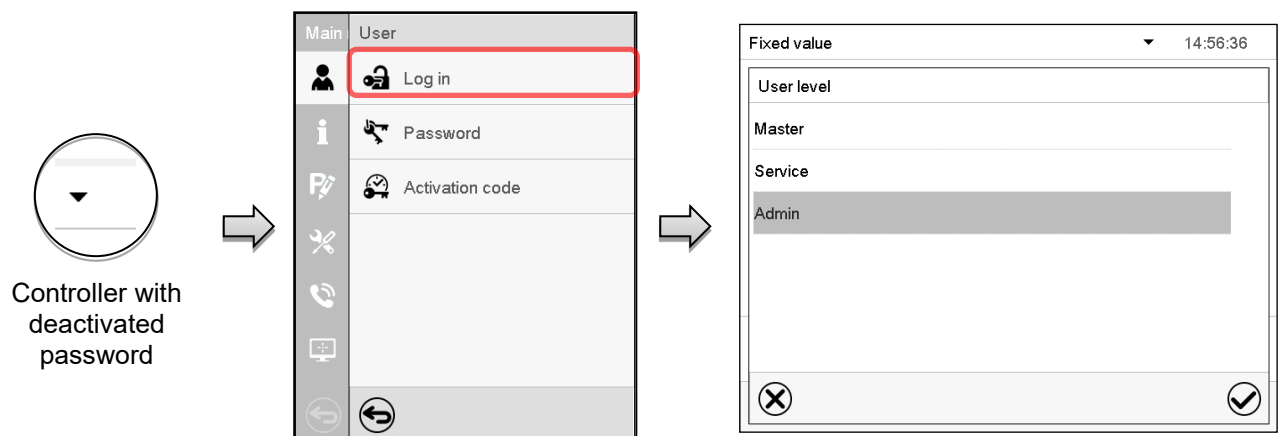

13.3 Log out

Path: [Main menu](#) > [User](#) > [Log out](#)

User logoff with “Admin” authorization

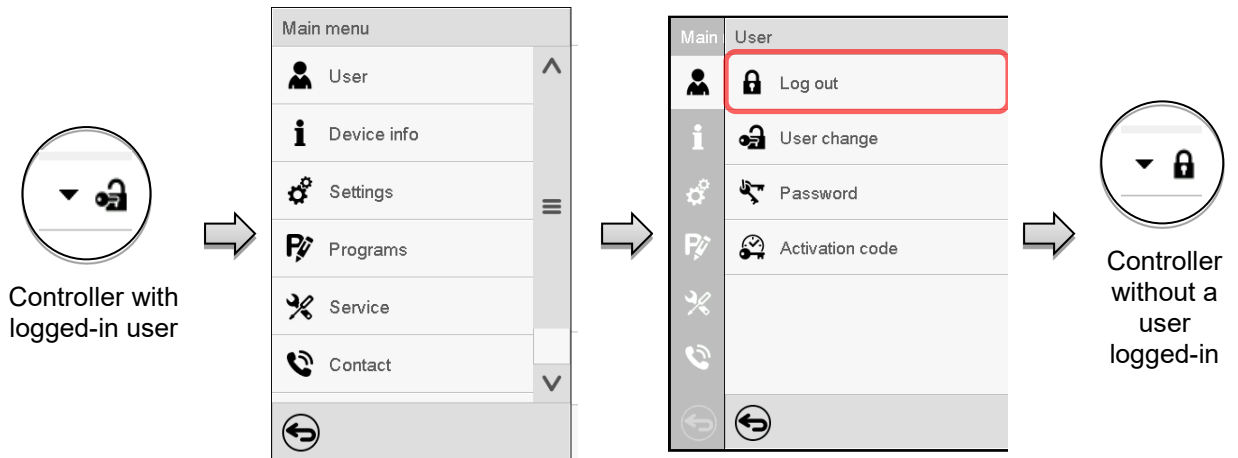

User logoff with “User” authorization

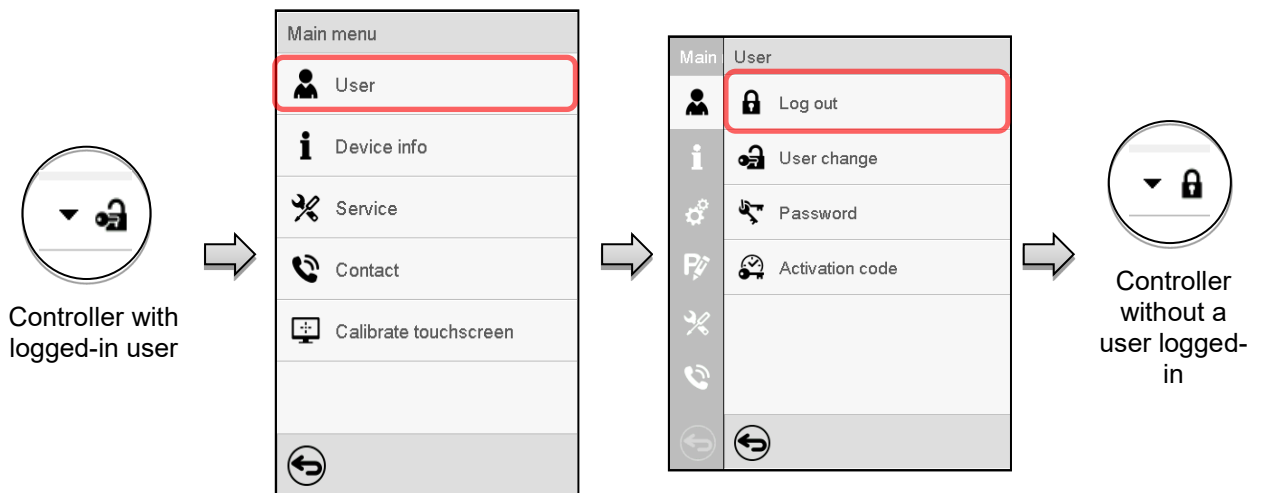

13.4 User change

If the password function has been deactivated (chap.13.5.2) this function is not available.

Path: [Main menu](#) > [User](#) > [User change](#)

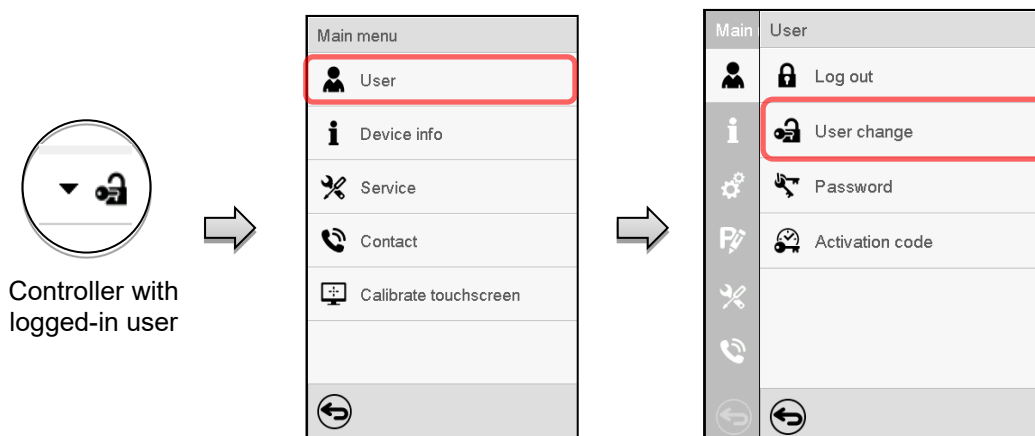



13.5 Password assignment and password change

This function is not available for a user logged-in with “User” authorization.

13.5.1 Password change

A logged-in user can change the passwords of his current level and of the next lower level(s).

Example: A user with “Admin” authorization can change the passwords for the “Admin” and “User” authorization levels.

Path: [Main menu](#) > [User](#) > [Password](#)

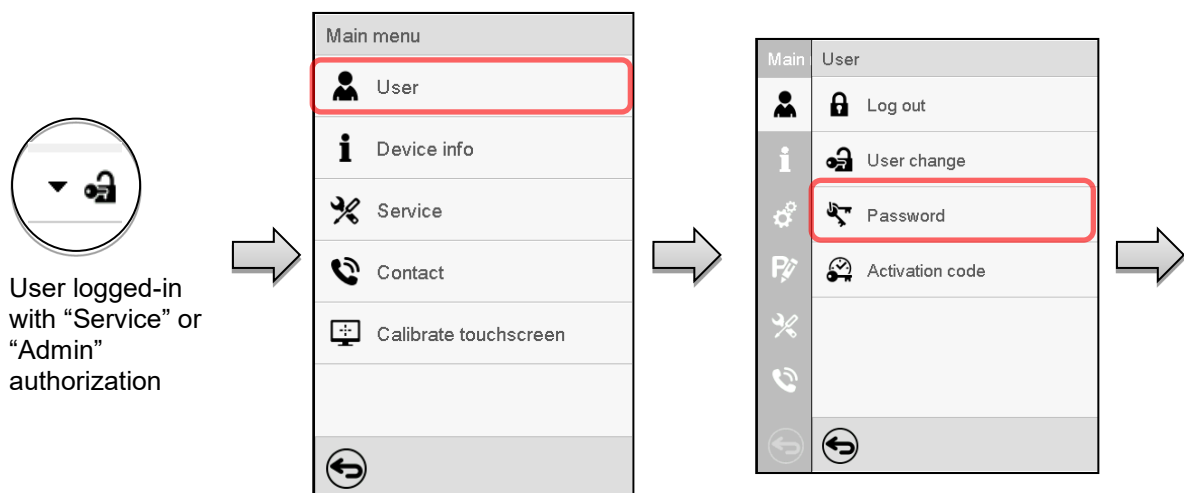

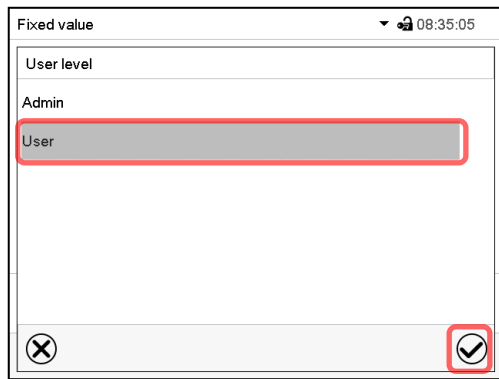

Selection of the authorization level
(example: view with "Admin" authorization)

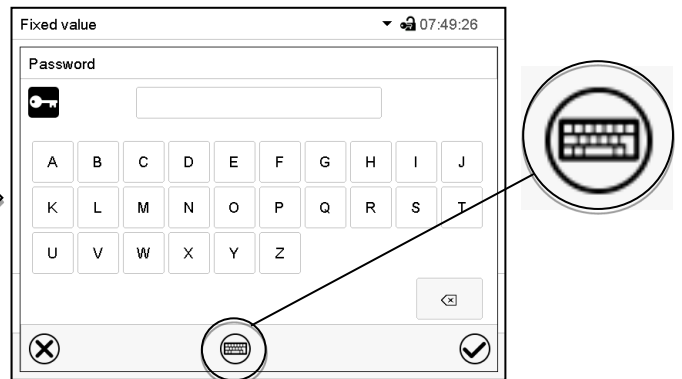

Enter desired password. If desired, press the **Change keyboard** icon to access other entry windows.

In the "Keyboard switch" window you can select different keyboards to enter uppercase and lowercase letters, digits, and special characters. All types of characters can be combined within one single password.

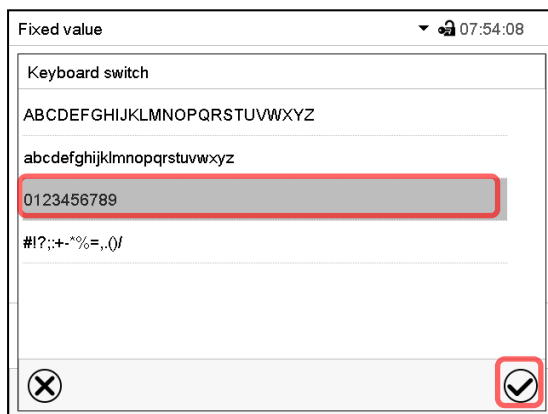

Example: access the digit entry window

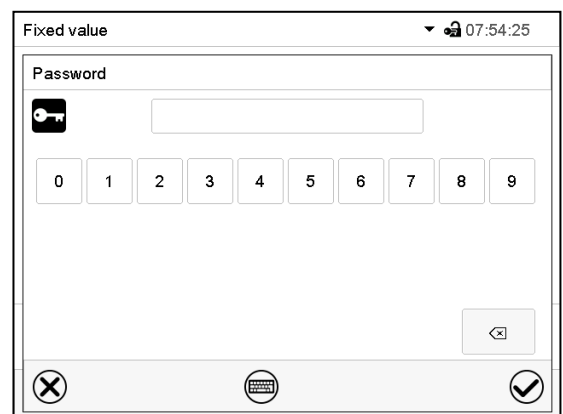

Entry of digits

To confirm the entry, press the **Confirm** icon.

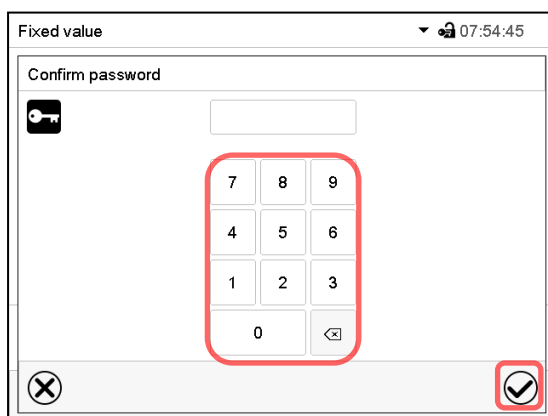

Repeat the password entry for confirmation (sample picture). For each character of the password, the required keyboard appears automatically.

Then press the **Confirm** icon.

13.5.2 Deleting the password for an individual authorization level

A user logged-in with “Service” or “Admin” authorization can delete the passwords of his current level and of the next lower level(s). To do this no password is entered during a password change.

Path: [Main menu](#) > [User](#) > [Password](#)



Controller with logged-in user (e.g. with “Admin” authorization)

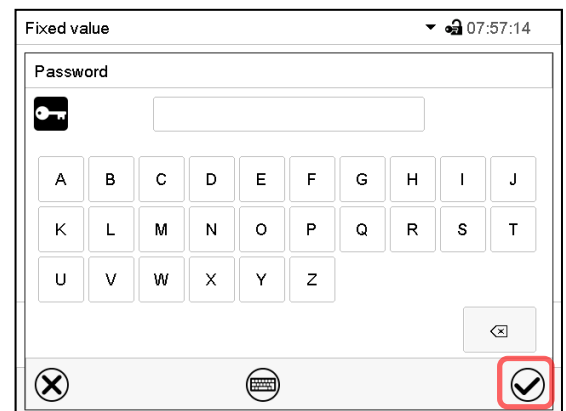
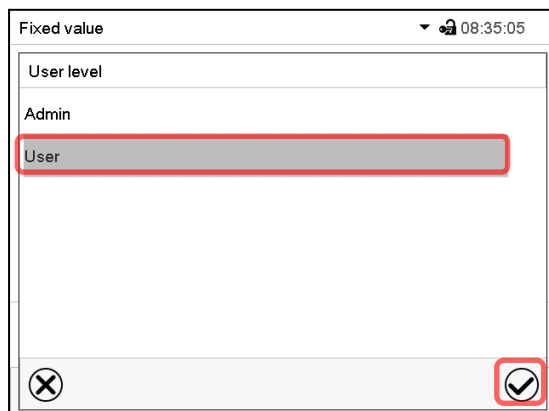
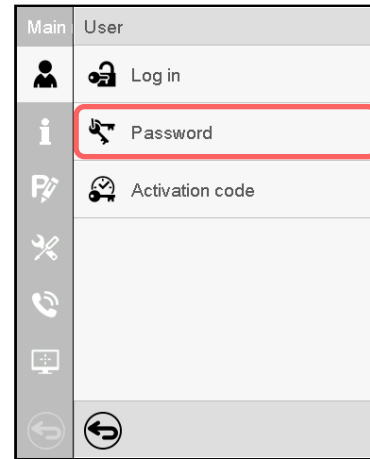
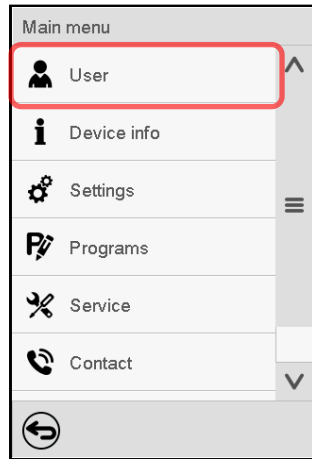

Select the authorization level for which the password shall be deleted.

Do NOT enter anything in the “Password” screen. Press the **Confirm** icon.

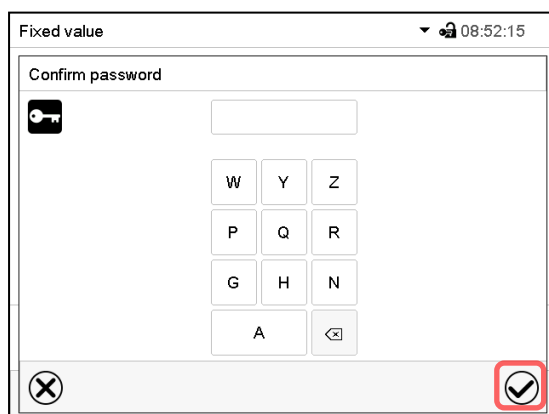

The password is deleted.

Do NOT enter anything in the “Confirm password” screen. Press the **Confirm** icon.

13.5.3 New password assignment for “service” or “admin” authorization level when the password function was deactivated

If the password protection for an authorization level has been deactivated, i.e., no password is assigned, no login for this level is possible. Therefore access to this authorization level is available without login.

If the password for the “Service” or “Admin” authorization has been deleted (chap. 13.5.2), a new password can be assigned for the current level and the next lower level(s) without user login.

Example: The password for the “Admin” authorization level was deleted, therefore every user without login has full access to the functions of the “Admin” authorization level. If access to this level shall become password protected again, the user can assign a new password for the “Admin” authorization level with the “Password” function.

Path: [Main menu](#) > [User](#) > [Password](#)

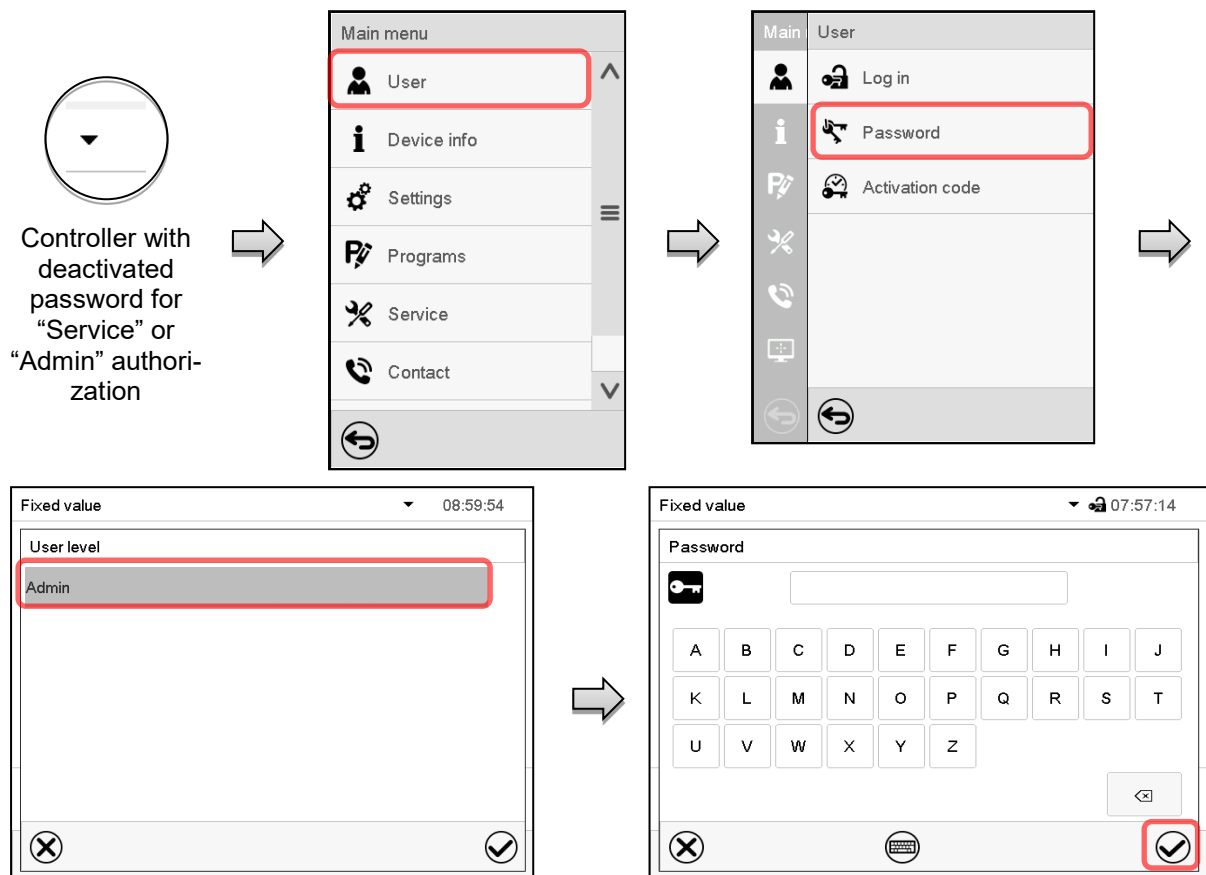

Select the authorization level, for which you want to assign a password.

(Example: “Admin” authorization)

Enter the desired password. If desired, press the **Change keyboard** icon to access other entry windows.

To confirm the entry, press the **Confirm** icon.

Repeat the password entry for confirmation. For each character of the password, the required keyboard appears automatically. Then press the **Confirm** icon.

13.6 Activation code

Certain functions of the controller can be unlocked with a previously generated activation code.

The activation code enables access to functions available only in the “Service” authorization level by users without a “Service” authorization. Such functions include e.g., adjustment or extended configurations.

The activation code is available in authorization levels.

Path: [Main menu > User > Activation code](#)

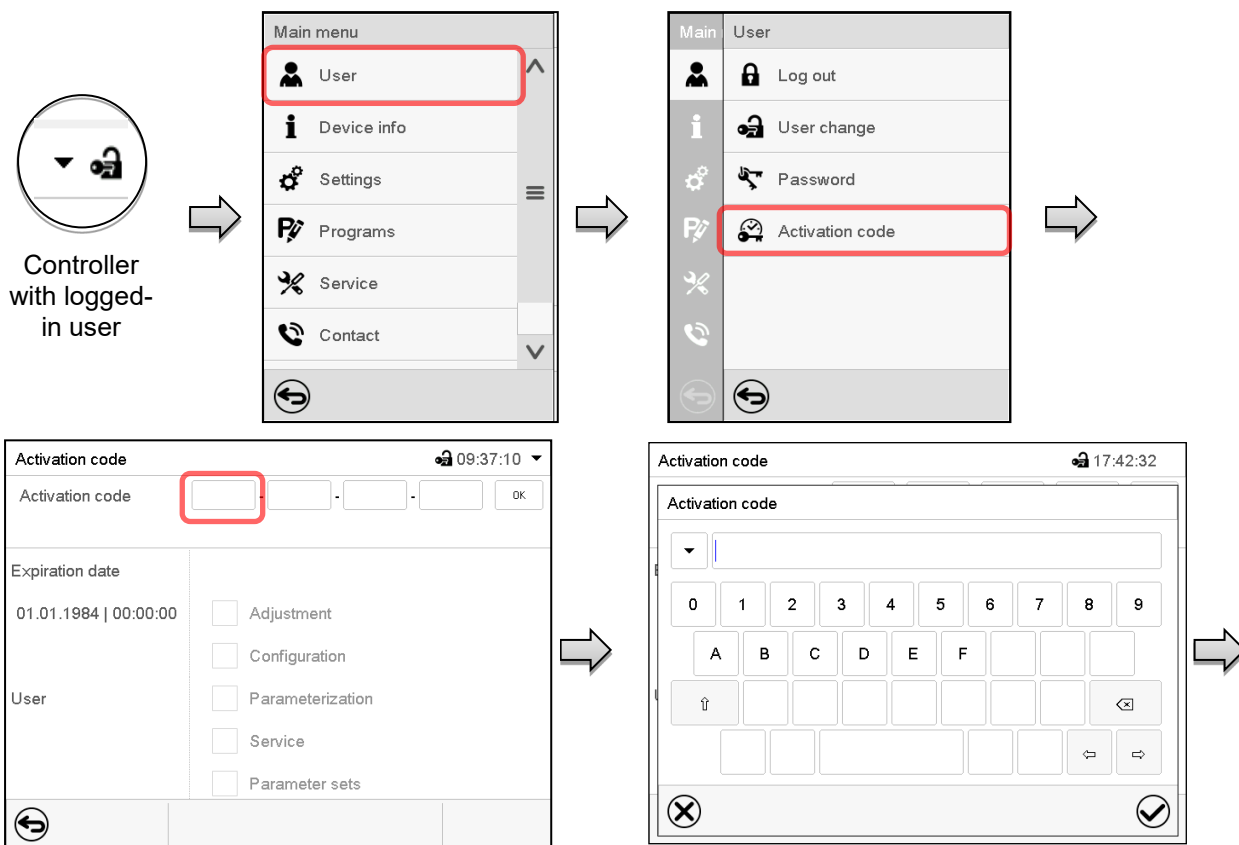

Activation code menu.

Select the first of the four entry fields.

Activation code entry window.

Enter the first four characters of the activation code and press the **Confirm** icon.

Select the next of the four entry fields and proceed accordingly until the entire code has been entered.

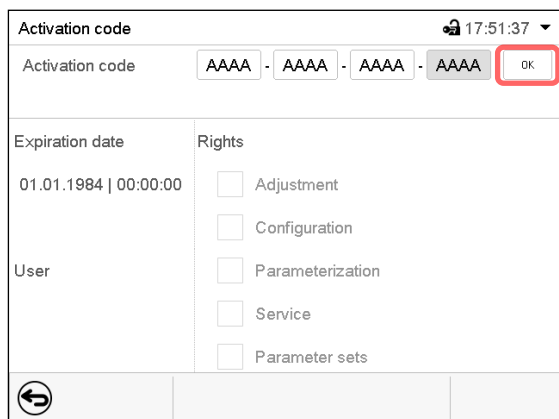

“Activation code” menu with entered code (sample view).

Press **OK** to take over the entry

The available functions are indicated by marked checkboxes.

Example: Extended configurations available.

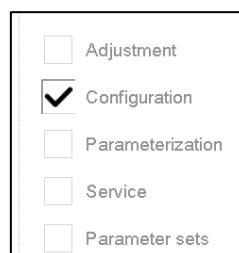

Under “Expiration date” the date of expiry of the code is displayed.

14. General controller settings

Most of the general settings can be accessed in the “Settings” submenu, which is available for users with “Service” or “Admin” authorization level. It serves to enter date and time, select the language for the controller menus and the desired temperature unit and to configure the controller’s communication functions.

14.1 Selecting the controller’s menu language

The MB2 program controller communicates by a menu guide using real words in German, English, French, Spanish, and Italian.

Path: [Main menu](#) > [Settings](#) > [Chamber](#)

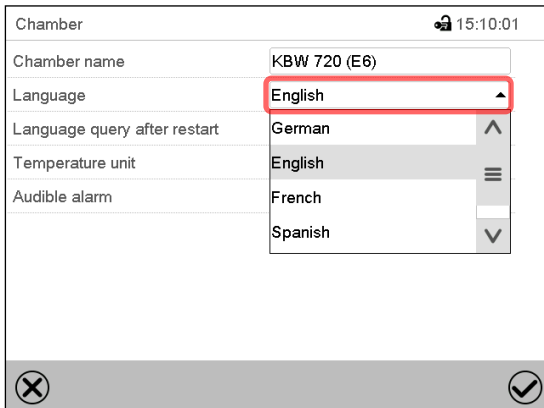

The screenshot shows the 'Chamber' submenu for a KBW 720 (E6) unit. The 'Language' dropdown menu is open, and 'English' is highlighted. Other options include German, French, and Spanish. The time is 15:10:01.

“Chamber” submenu (example).

Select the desired language.

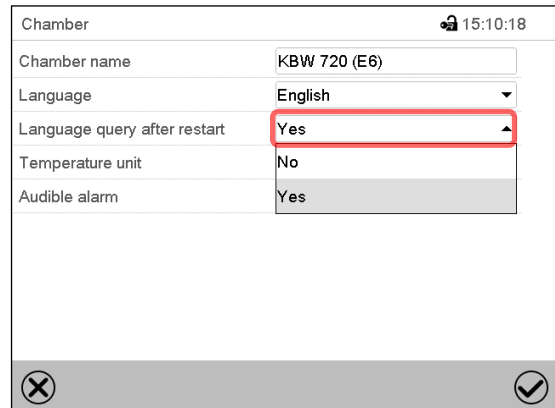

The screenshot shows the 'Chamber' submenu for a KBW 720 (E6) unit. The 'Language query after restart' dropdown menu is open, and 'Yes' is highlighted. Other options include 'No'. The time is 15:10:18.

“Chamber” submenu (example).

Select if there shall be a language query after restarting the chamber and press the **Confirm** icon.

Return to Normal display with the **Back** icon to take over the entries.

14.2 Setting date and time

Following start-up of the chamber after language selection:

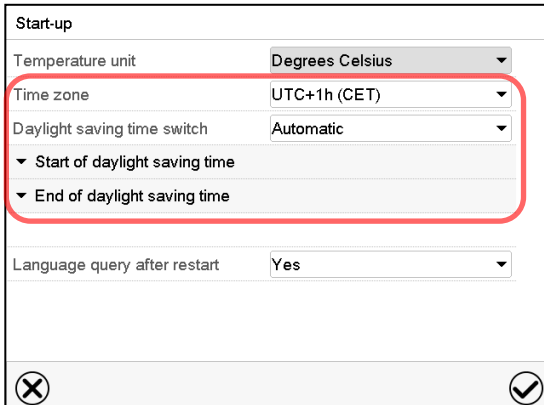

The screenshot shows the 'Start-up' submenu. The 'Time zone' dropdown menu is open, and 'UTC+1h (CET)' is highlighted. Other options include 'Automatic'. The time zone is set to 'UTC+1h (CET)'. The language query after restart is set to 'Yes'.

Select the time zone and configure the daylight-saving time switch.

Or later:

Path: [Main menu](#) > [Settings](#) > [Date and time](#)

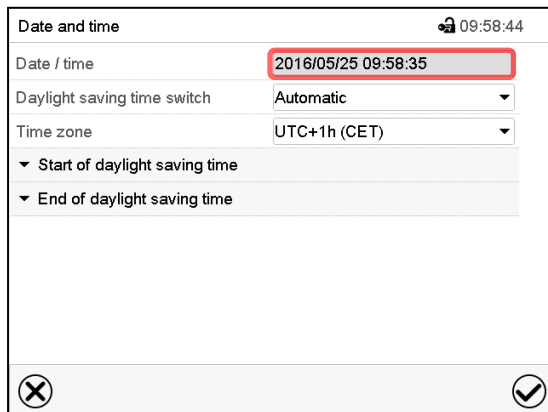

“Date and time” submenu.

Select the field “Date / time”.

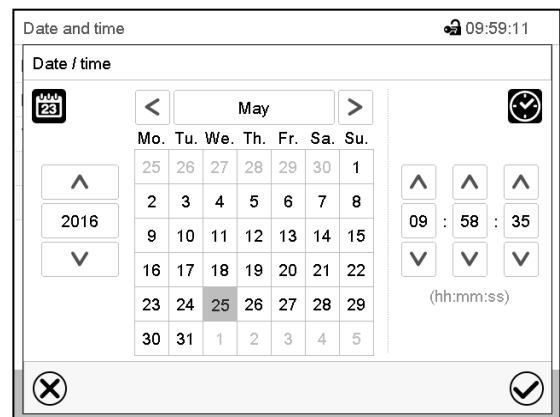

“Date / time” entry menu.

Enter date and time and press the **Confirm** icon.

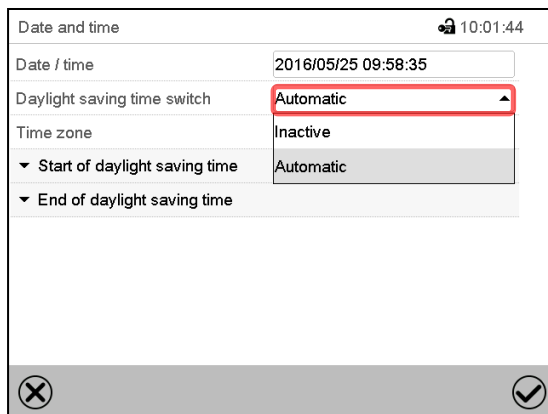

“Date and time” submenu.

In the field “Daylight saving time switch” select the desired setting “Automatic” or “Inactive”.

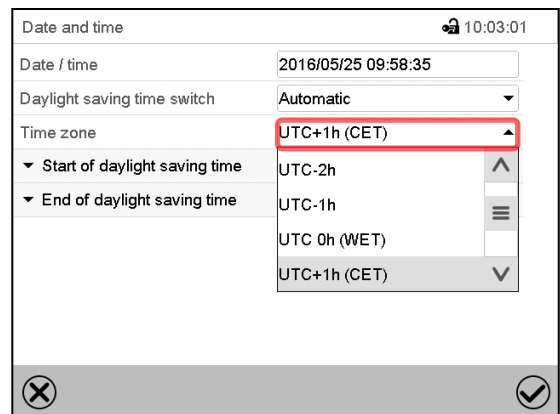

“Date and time” submenu.

Select the desired time zone and press the **Confirm** icon.

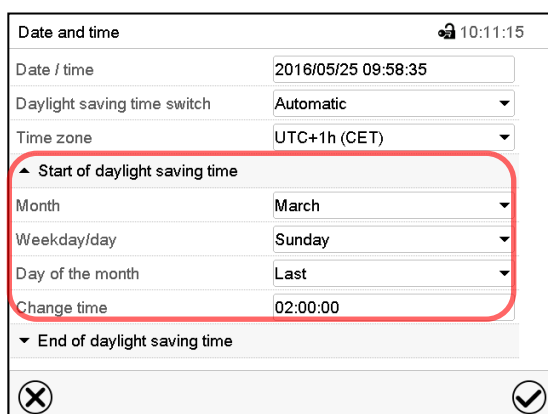

“Date and time” submenu.

Select the desired start of the daylight-saving time.

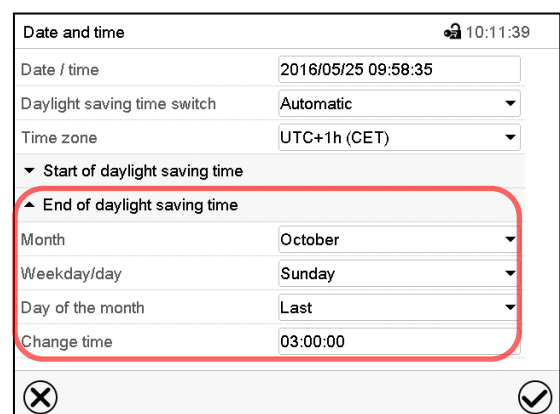

“Date and time” submenu.

Select the desired end of the daylight-saving time and press the **Confirm** icon.

After completing the settings, press the **Confirm** icon to take over the entries and exit the menu, **or** press the **Close** icon to exit the menu without taking over the entries.

14.3 Selecting the temperature unit

Following start-up of the chamber:

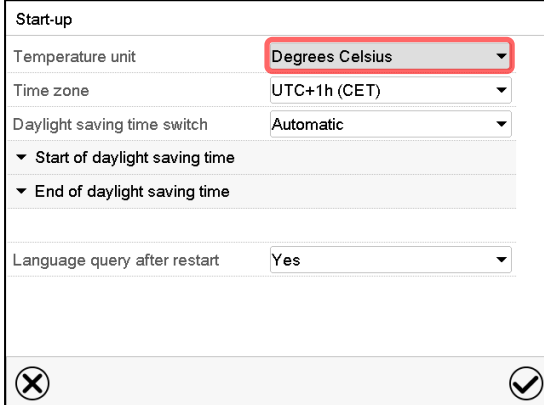

Or later:

Path: [Main menu](#) > [Settings](#) > [Chamber](#)

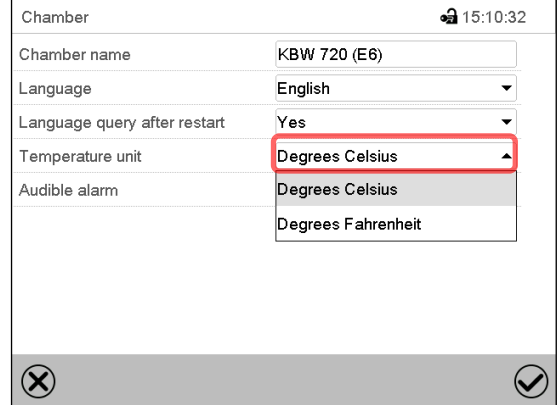

Select the desired temperature unit and press the **Confirm** icon.

Change of the temperature unit between °C and °F.

If the unit is changed, all values are converted accordingly

	C = degree Celsius	0 °C = 31°F	Conversion: [value in °F] = [value in °C] * 1,8 + 32
	F = degree Fahrenheit	100 °C = 212°F	

14.4 Display configuration

14.4.1 Adapting the display parameters

This function serves to configure parameters like display brightness and operating times.

Path: [Main menu](#) > [Settings](#) > [Display](#) > [Display](#)

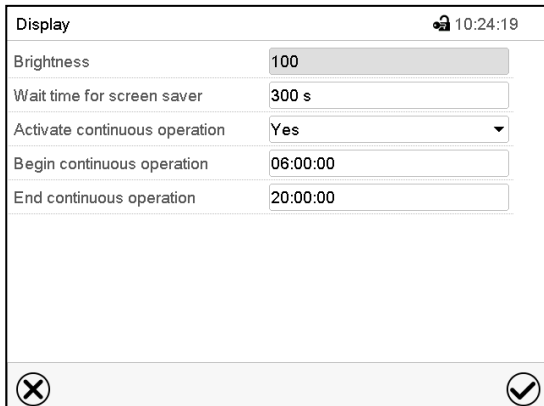

“Display” submenu.

- Select the field “Brightness”.

Move the grey slide to the left or right to define the brightness of the display

- left = darker (minimum value: 0)
- right = brighter (maximum value: 100)

Press the **Confirm** icon.

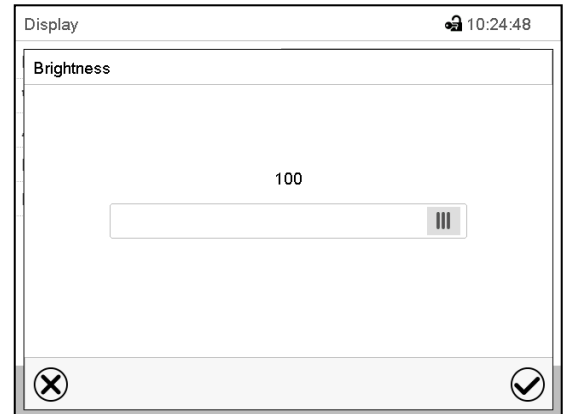

- Select the field “Wait time for screen saver” and enter the desired waiting time for the screen saver in seconds. Setting range: 10 sec up to 32767 sec. During the waiting time the display is off. Confirm entry with **Confirm** icon.
- In the field “Activate continuous operation” select the desired setting “Yes” or “No”.

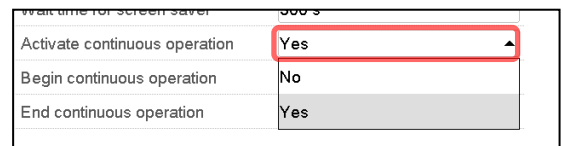

- Select the field “Begin continuous operation” (possible only if continuous operation is activated) and enter the time with the arrow keys. Confirm entry with **Confirm** icon.
- Select the field “End continuous operation. (only possible if continuous operation is activated) and enter the time with the arrow keys. Confirm entry with **Confirm** icon.

After completing the settings, press the **Confirm** icon to take over the entries and exit the menu, **or** press the **Close** icon to exit the menu without taking over the entries.

14.4.2 Touchscreen calibration

This function serves to optimize the display for the user’s individual angular perspective.

Path: [Main menu](#) > [Calibrate touchscreen](#)

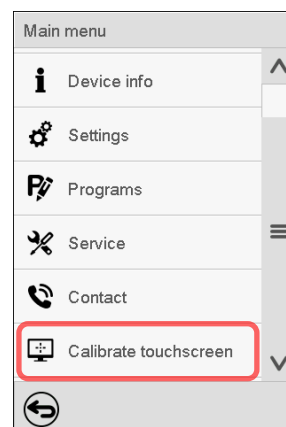
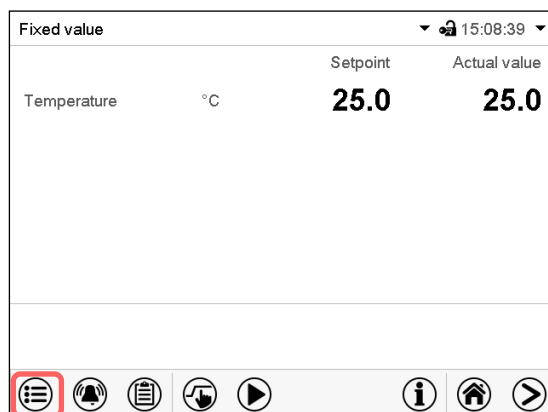

Normal display.

Select “Calibrate touchscreen” and follow the instructions on the display.

You need to touch all four corners of the touchscreen to calibrate it. Appropriate boxes appear successively in each corner.

	<p>The waiting icon shows how much time there is left to touch the currently activated box. If the box is not touched within this period, calibration is aborted and the display changes to Normal display.</p>
---	---

After completing the calibration, i.e., touching all four boxes, the display changes to Normal display.

14.5 Network and communication

For these settings at least the “Admin” authorization level is required.

14.5.1 Serial interfaces

The chamber is optionally equipped with a serial RS485 interface.

This menu allows to configure the communication parameters of the RS485 interface.

The device address is required to recognize chambers with this interface type in a network, e.g. when connecting it to the optional APT-COM™ 4 Multi Management Software (chap. 19.1). In this case do not change the other parameters.

Path: [Main menu](#) > [Settings](#) > [Serial interfaces](#)



“Serial interfaces” submenu.

- Select the desired setting in the field “Baud rate”.

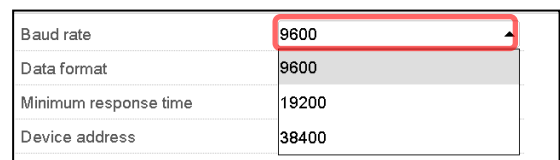

- Select the desired setting in the field “Data format”.

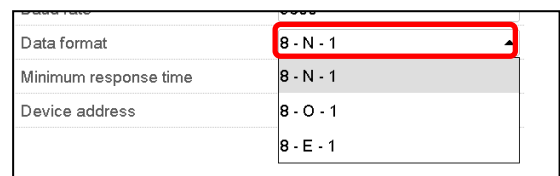

- Select the field “Minimum response time” and enter the desired minimum response time. Confirm entry with **Confirm** icon.
- Select the field “Device address” and enter the device address. Factory setting is “1”. Confirm entry with **Confirm** icon.

After completing the settings, press the **Confirm** icon to take over the entries and exit the menu, **or** press the **Close** icon to exit the menu without taking over the entries.

14.5.2 Ethernet

14.5.2.1 Configuration

Path: [Main menu](#) > [Settings](#) > [Ethernet](#)

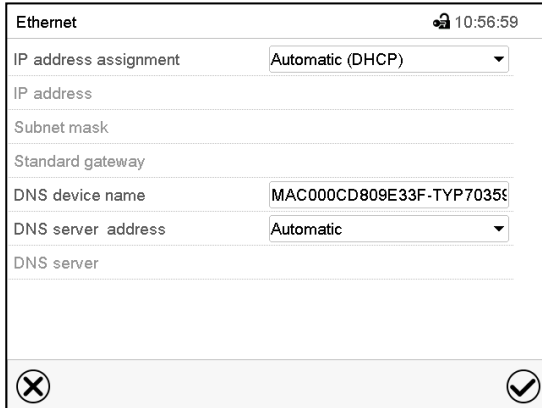

“Ethernet” submenu.

- In the field “IP address assignment” select the desired setting “Automatic (DHCP)” or “Manual”.

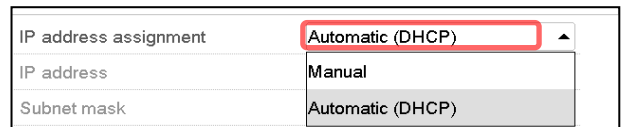

With selection “Manual” you can enter the IP-address, the subnet mask and the standard gateway manually.

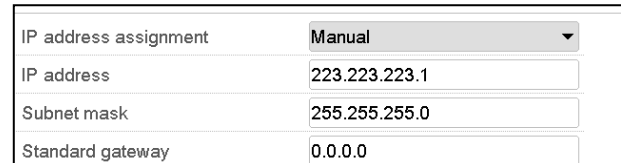

- Select “DNS device name” and enter the DNS device name. Confirm entry with **Confirm** icon.
- In the field “DNS server address” select the desired setting “Automatic” or “Manual”.

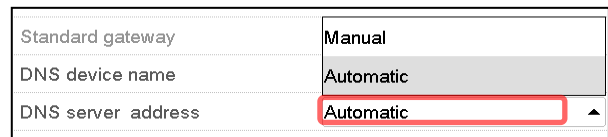

With selection “Manual” you can enter the DNS server address manually.

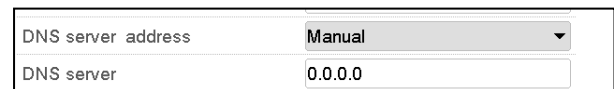

After completing the settings, press the **Confirm** icon to take over the entries and exit the menu, **or** press the **Close** icon to exit the menu without taking over the entries.

14.5.2.2 Display of the MAC address

Path: [Main menu](#) > [Device info](#) > [Ethernet](#)

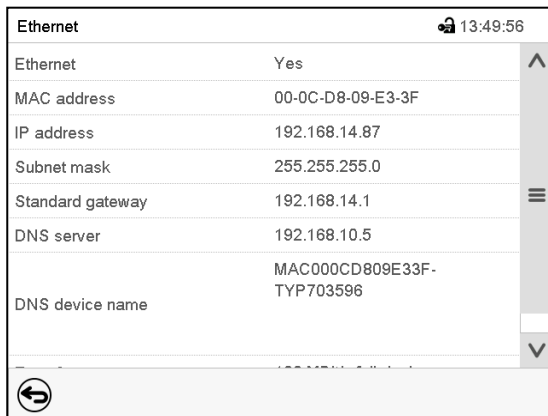

“Ethernet” submenu (example values).

14.5.3 Web server

This controller menu serves to configure the web server. Then you can enter the chamber’s IP-address in the Internet. The IP address is available via [Chamber information](#) > [Ethernet](#). The BINDER web server opens. Enter the user name and password which have been assigned for the web server in the controller menu. This enables online access to the controller display, to see e.g., the event list or error messages. In this view no settings can be changed.

Path: [Main menu](#) > [Settings](#) > [Web server](#)

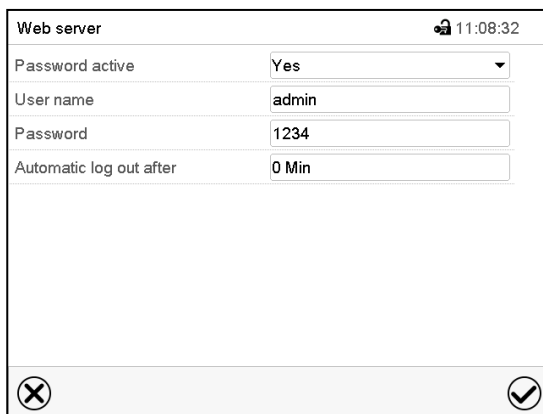

“Webserver” submenu.

- In the field “Password active” select the desired setting “Yes” or “No”.

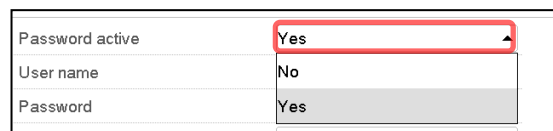

- Select the field “User name” and enter the desired user name. Confirm entry with **Confirm** icon.
- Select the field “Password” and enter the desired password. Confirm entry with the **Confirm** icon.
- Select the field “Automatic log out after” and enter the time in minutes after which the webserver shall log out automatically. Setting range: 0 min to 65535 min. Confirm entry with **Confirm** icon.

After completing the settings, press the **Confirm** icon to take over the entries and exit the menu, **or** press the **Close** icon to exit the menu without taking over the entries.

14.5.4 E-Mail

As soon as an alarm was triggered, an e-mail is sent to the configured e-mail address.

Path: [Main menu](#) > [Settings](#) > [Email](#)

E-mail address entry:

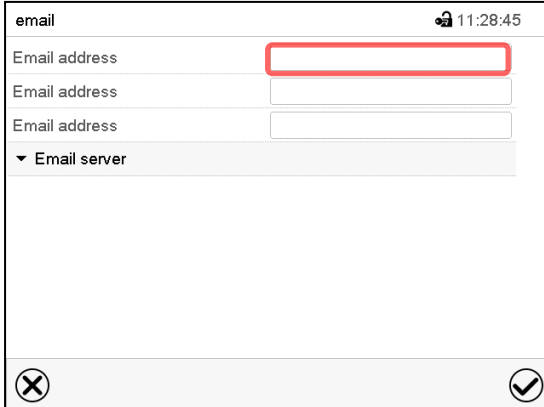

“Email” submenu.

Select the desired e-mail address field and enter the e-mail address. You can use the **Keyboard change** icon for entry. Confirm entry with **Confirm** icon.

E-mail server settings:

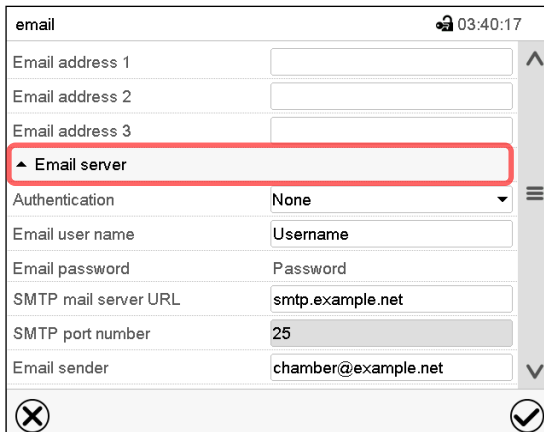

“Email” submenu.

Select the field “Email server” to access the settings

- In the field “Authentication” select the desired setting “None” or “SMTP” auth“.

With the setting “SMTP auth”, you can enter a password under “Email password”.

Authentication	None
Email user name	None
Email password	SMTP auth
SMTP mail server URL	192.168.10.45

- Select the field “Email user name” and enter the desired user name. Confirm entry with **Confirm** icon.
- Select the field “SMTP mail server URL” and enter the SMPT mail server URL. Confirm entry with **Confirm** icon.
- Select the field “SMTP port number” and enter the desired port number. Standard setting: “25”. Confirm entry with **Confirm** icon.
- Select the field “Email sender” and enter the desired Email sender. Confirm entry with **Confirm** icon.

After completing the settings, press the **Confirm** icon to take over the entries and exit the menu, **or** press the **Close** icon to exit the menu without taking over the entries.

14.6 USB menu: Data transfer via USB interface

The USB port is located in the instrument box.

When you insert a USB-stick, the “USB” menu opens.



The USB stick must be formatted with FAT32 and have at least 8GB of memory.

Depending on the user’s authorization level, different functions (highlighted in black) are available for the logged-in user.

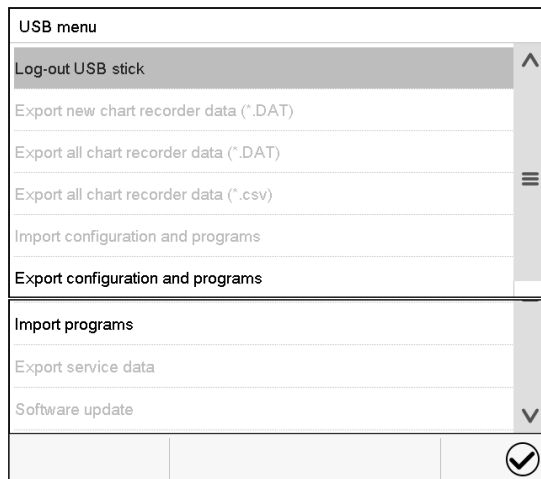

Available functions
with “User” authorization level

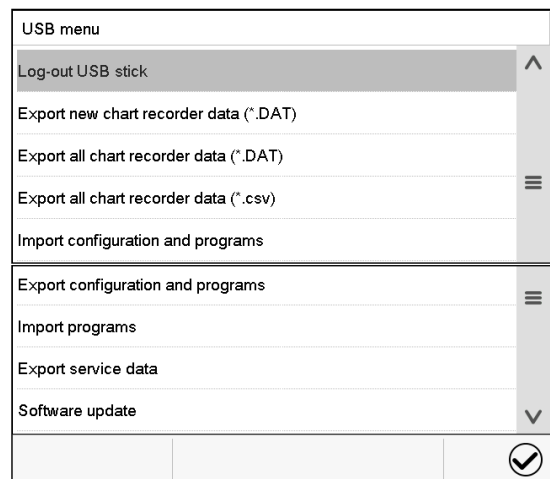

Available functions
with “Admin” authorization level

Function	Explanation
Log-out USB stick	Log-out USB stick bevor pulling it
Export new chart recorder data (*.DAT)	Export chart recorder data, which have been added since last export, in .dat format
Export all chart recorder data (*.DAT)	Export all chart recorder data in .dat format
Export all chart recorder data (*.csv)	Export all chart recorder data in .csv format
Import configuration and programs	Import configuration and timer / time / week programs
Export configuration and programs	Export configuration and timer / time / week programs
Import programs	Import timer / time / week programs
Export service data	Export service data (including self-test data, chap. 15.5)
Software update	Controller firmware update

15. General information

15.1 Service contact page

Path: [Main menu](#) > [Contact](#)

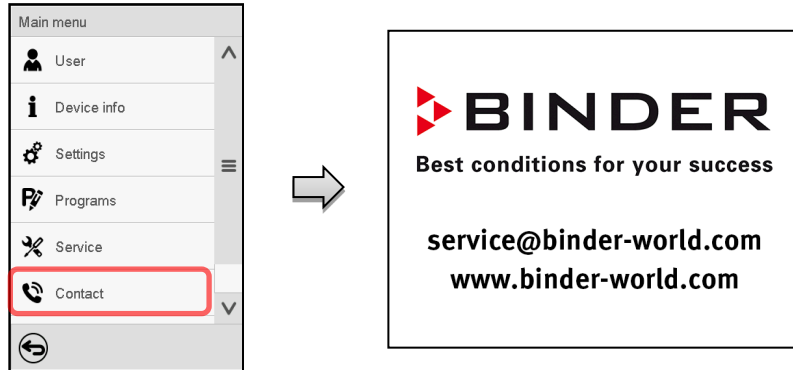

15.2 Current operating parameters

 Press the **Information** icon to access the “Info” menu from Normal display.

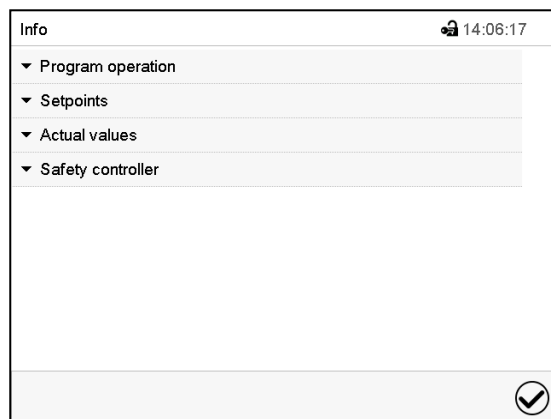

“Info” menu.
Select the desired information.

- Select “Program operation” to see information on a currently running program
- Select “Setpoints” to see information on the entered setpoints, light control and special controller functions.
- Select “Actual values” to see information on the current actual values.
- Select “Safety controller” to see information on the safety controller status.

15.3 Event list

The “Event list” displays status information and errors of the current day. It enables to view the last 100 events or defective conditions of the chamber.

 Press the **Event list** icon to access the event list from Normal display.

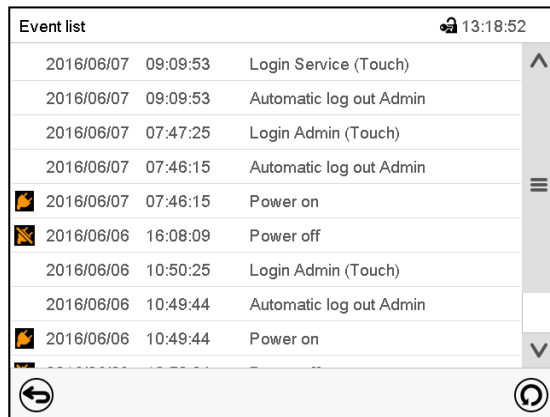













Event list

 Press the **Update** icon to update the event list.

 **Attention:** Following a modification of the language setting (chap. 14.1) or the storage interval of the chart recorder (chap. 16.2) the Event list is cleared.

15.4 Technical chamber information

Path: [Main menu](#) > [Device info](#)

Main	Device info		
	 General	Chamber name and setup	
	 Versions	Versions of CPU, I/O module and safety controller	for BINDER Service
	 In-/Outputs	Information on digital and analog inputs and outputs and phase angle outputs	for BINDER Service
	 Modbus inputs	Information on modbus analog and digital inputs	for BINDER Service
	 Ethernet	Information on Ethernet connection, MAC address display	chap. 14.5.2
			
		Back to main menu	

15.5 Self-test function

The self-test function enables an automated check of the proper chamber functioning as well as a targeted and reliable fault analysis. It is available with the “Master”, “Service”, and “Admin” authorization levels.

In this case, the chamber successively undergoes various defined operating states, which serves to determine reproducible characteristic values. These characteristic values provide information on the performance and precision of the individual functional systems of the chamber (e.g., heating, refrigeration, humidification) of the chamber.

The results of the self-test are stored in the service recorder of the controller. You can export them using the controller’s USB interface and send them to BINDER Service (use function “Export service data” to USB stick, chap. 14.6). BINDER Service will evaluate the data using an analyzing tool.

Activating the self-test mode

	<p>In order to allow an optimum comparison of the determined characteristic values with the reference characteristic values, the ambient temperature should be in the range of +22 °C +/- 3 °C / 71.6 °F +/- 5.4 °F.</p> <p>The chamber shall be unloaded (empty with standard equipment).</p>
---	--

Path: [Main menu](#) > [Settings](#) > [Various](#)

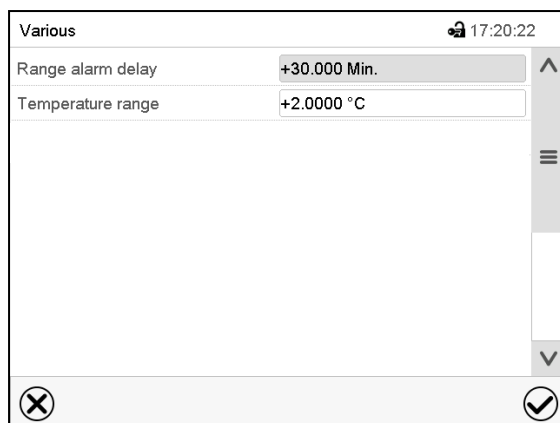

Submenu “Various”.

Scroll all the way down to access the “Self-test” function.



Submenu “Various”.

Select the field “Self-test”.

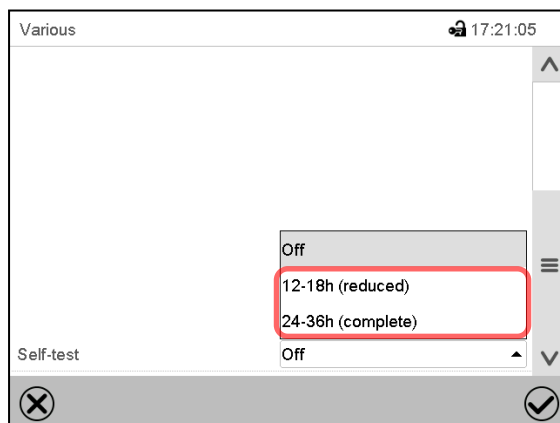

Submenu “Various”.

To start the self-test, select the desired test duration. Confirm entry with **Confirm** icon.

Return to Normal display with the **Back** icon to take over the entries.

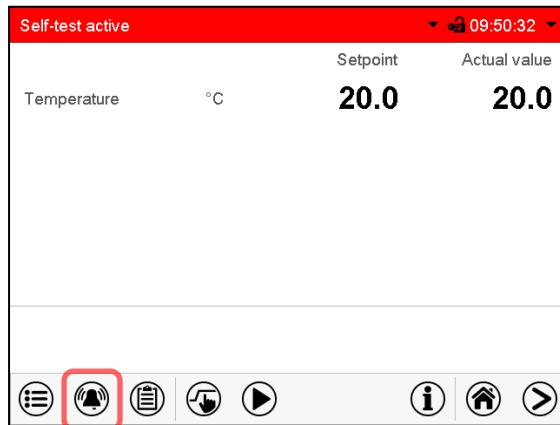

Alarm message “Self-test active”.

The self-test program is running. The indicated set-points are non-functional.

With enabled buzzer: the buzzer sounds. Press the **Alarm** icon to access the “Active alarms” menu.

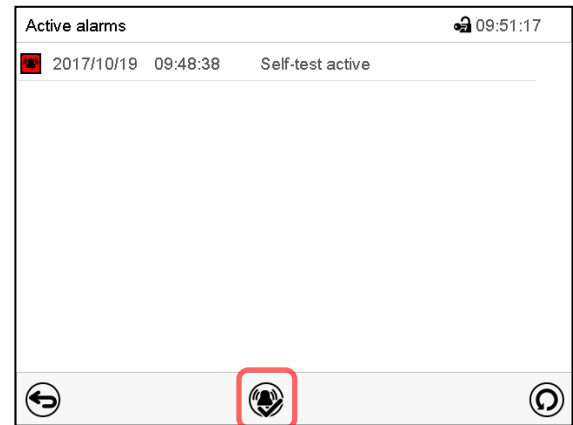

“Active alarms” menu.

The zero-voltage relay alarm output is not activated with the alarm message “Self-test active”.

Press the **Reset alarm** icon to mute the buzzer.



Do not open and do not turn off the chamber while self-test is running.

After an interruption of the voltage supply, the self-test restarts.

Deactivating the self-test mode

Opening the chamber door will cancel the self-test.

This step allows you to cancel the self-test or deactivate the self-test mode after the chamber has completed the self-test or the self-test has been cancelled.

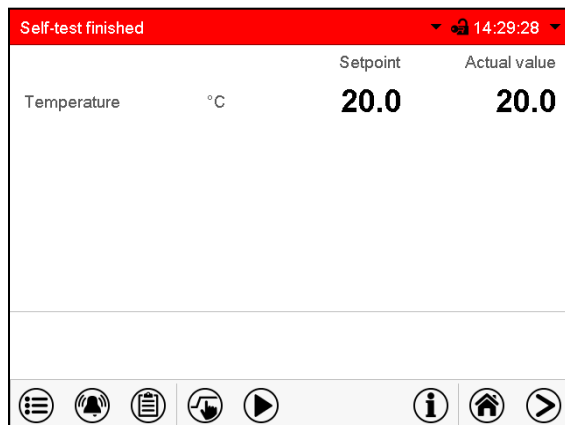

Alarm message “Self-test finished”.

The chamber is in Fixed-value mode and equilibrates to the indicated set-points.

With enabled buzzer: the buzzer sounds. Press the **Alarm** icon to access the “Active alarms” menu. Press the **Reset alarm** icon to mute the buzzer.

The self-test is completed. You can now deactivate the self-test mode.

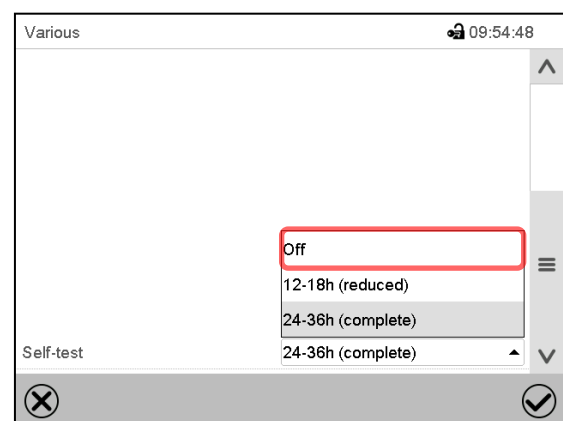

Submenu “Various”.

Select the setting “off” to deactivate the self-test mode after the self-test is completed or has been cancelled by opening the door, or to cancel a running self-test.

Confirm entry with **Confirm** icon.



The alarm messages “Self-test active” and “Self-test finished” do not activate the zero-voltage relay alarm output. They are listed in the Event list.

16. Chart recorder display

This view offers graphic representation of the measurement course. Data representation imitates a chart recorder and allows recalling any set of measured data at any point of time taken from the recorded period.

16.1 Views

	Press the Change view icon to access the pen recorder display.
--	---

16.1.1 Show and hide legend

	Show legend		Hide legend
--	--------------------	--	--------------------

Press the **Show legend** icon to display the legend on the right side of the display

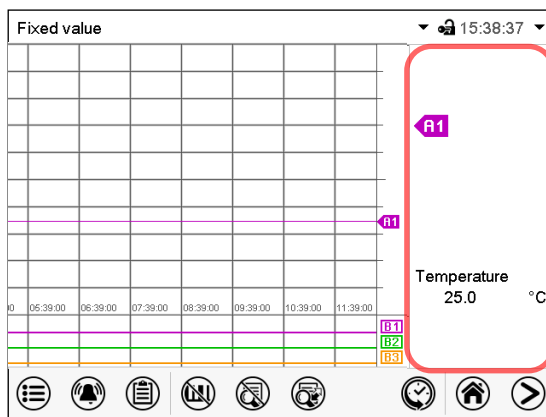

Legend shown on the right side of the display

16.1.2 Switch between legend pages

	Switch legend
--	----------------------

Press the **Switch legend** icon to switch between the legend pages

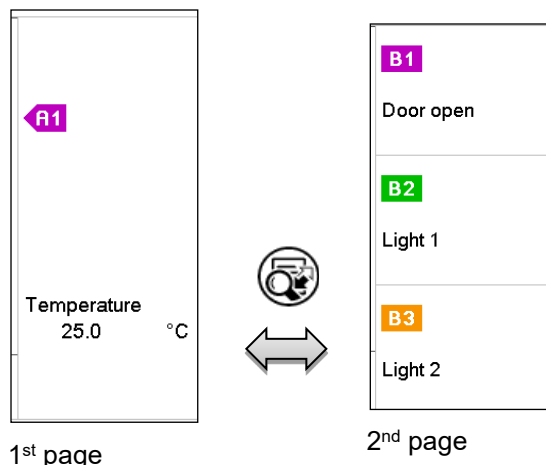

Switching between the legend pages

16.1.3 Show and hide specific indications

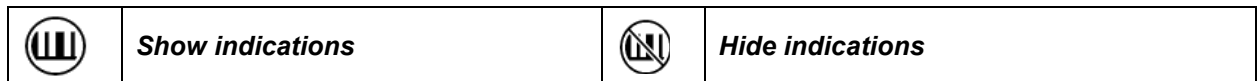

Press the **Show indications** icon to display the indications “Door open” (B1), “Light Level 1” (B2) and “Light Level 2” (B3).

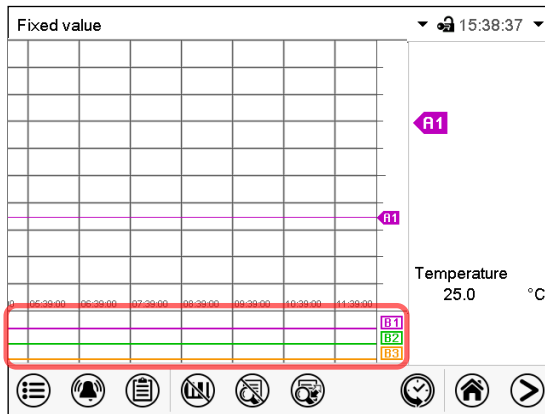

Indications “Door open” (B1), “Light Level 1” (B2) and “Light Level 2” (B3) are displayed.

16.1.4 History display

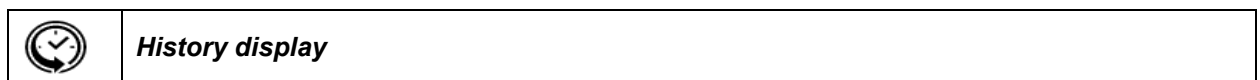

Press the **History display** icon to change to the history display.

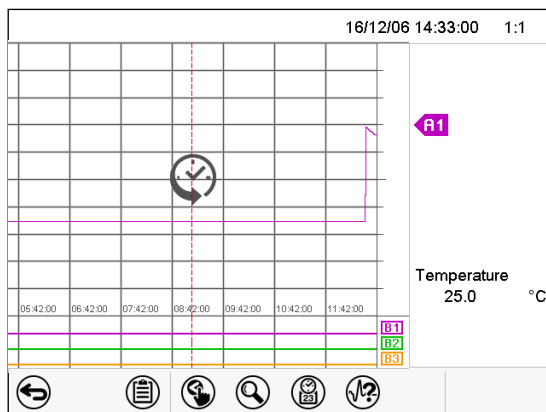

History display.

The chart recorder is paused. Data recording continues in the background.

Move the central red line by tapping and holding to the desired position.

The legend at the right side shows the values of the current line position.

Then further icons appear:

History display: Curve selection

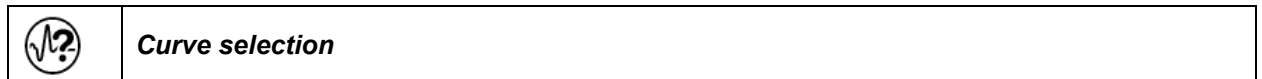

Press the **Curve selection** icon to access the “Curve selection” submenu.

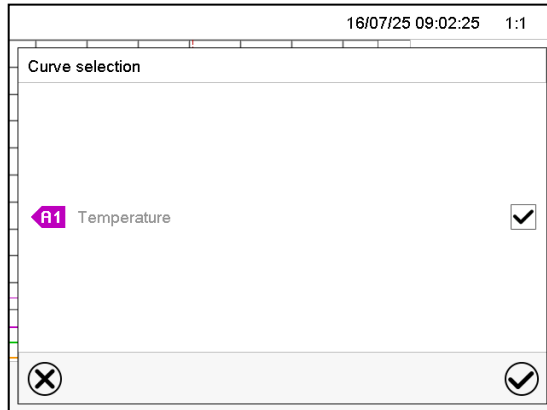

“Curve selection” submenu.

Select the curves to be displayed by checking the checkbox of the corresponding parameter. Press the **Confirm** icon

History display: Search the required instant



Press the **Search** icon to access the “Search” submenu.

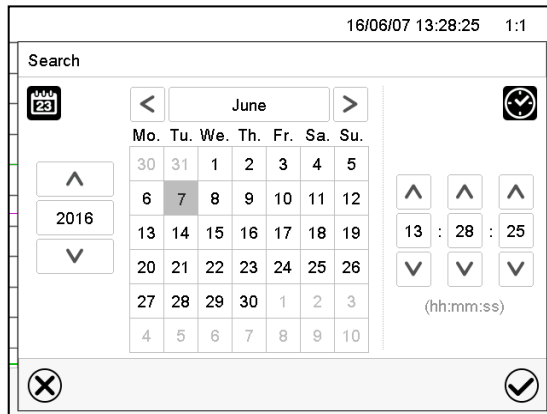

“Search” submenu.

Select the required instant by entering its date and time and press the **Confirm** icon

History display: Zoom function



Press the **Zoom** icon to access the “Zoom” submenu.

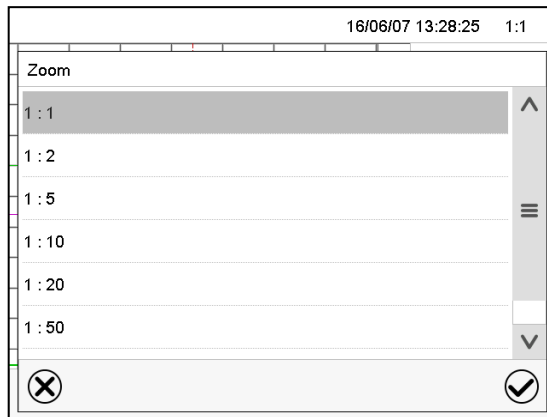

“Zoom” submenu.

Select the zoom factor and press the **Confirm** icon

History display: Show and hide *scroll buttons* to scroll to an instant



Press the **Show scroll buttons** icon to access the “Page selection” submenu.

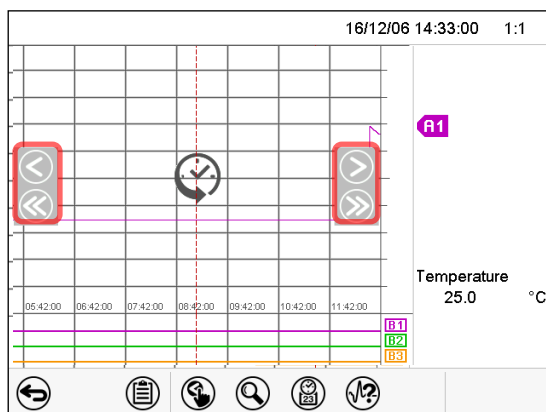

“Page selection” submenu.

Scroll buttons are shown on the left and on the right. Use them to move along the timeline.

16.2 Setting the parameters

This menu allows setting the storage interval, the type of values to be shown and the scaling of the temperature charts.

Path: **Main menu > Settings > Measurement chart**

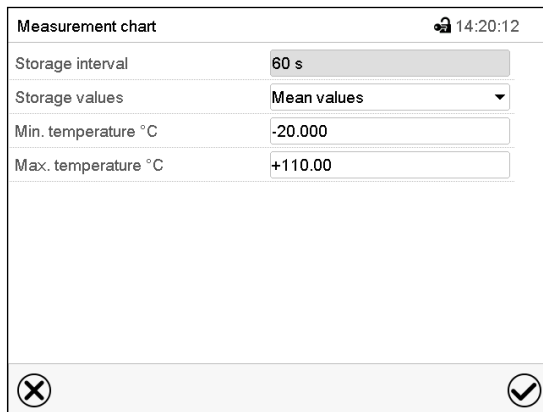

“Measurement chart” submenu.

- Select the field “Storage interval” and enter the desired storage interval. Confirm entry with **Confirm** icon.

The available presentation depends on the pre-selected storage rate. Factory setting: 60 seconds. This means the higher the storage rate, the more precisely but shorter the data representation will be.

- In the field “Storage values” select the desired value type to be displayed.

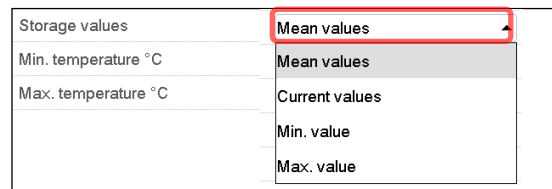

- For scaling the representation select the desired minimum and maximum temperature value and enter the desired values. Temperature display range: -20 °C up to 110 °C. Confirm entry with **Confirm** icon.

Setting the storage rate or rescaling (minimum and/or maximum) will clear the measured-value memory and the event list.

	NOTICE
	<p>Danger of information loss when setting the storage rate or rescaling.</p> <p>Data loss of measured-value memory and event list.</p> <p>➤ Change the storage rate or scaling ONLY if the previously registered data is no longer needed.</p>

After completing the settings, press the **Confirm** icon to take over the entries and exit the menu, **or** press the **Close** icon to exit the menu without taking over the entries.

17. Defrosting at refrigerating operation

BINDER growth chambers with light are very diffusion-proof. To ensure high temperature precision there is no automatic cyclic defrosting device. The DCT™ refrigerating system largely avoids icing of the evaporation plates. However, at very low temperatures the moisture in the air can condense on the evaporator plates leading to icing.



Always close the door properly.

Operation with temperature set-points above +5 °C / 41 °F at an ambient temperature of 25 °C / 77 °F:

The air defrosts the ice cover automatically. Defrosting is continually performed.

Operation with temperature set-points below +5 °C / 41 °F:

Icing on the evaporator is possible. Defrost the chamber manually.



With temperature set-points < +5 °C / 41 °F, regularly defrost the chamber manually:

- Set the temperature to 40 °C / 104 °F (in Fixed value entry mode).
- Let the chamber operate for approx. 30 minutes with the door closed.



Too much ice on the evaporator is noticeable by reduced refrigerating performance.

When turning off the chamber following prolonged refrigerating operation below +5 °C / 41 °F, there is danger of overflowing due to uncontrolled defrosting of icing on the evaporator.



NOTICE

**Danger of overflowing due to uncontrolled defrosting of icing on the evaporator.
Damage to the surroundings of the chamber.**

After several days of refrigerating operation below +5 °C / 41 °F:

- ⊘ Do NOT directly turn off the chamber.
- Manually defrost the chamber (see description above).
- Then shut down the chamber at the main power switch (1).

18. Illumination system

18.1 Illumination for optimal plant growth

The chambers are equipped with day light fluorescent tubes. Optionally available are efficient FLUORA® growth illumination tubes for optimal plant growth or special Arabidopsis lamps. The fluorescent tubes are built in light cassettes.

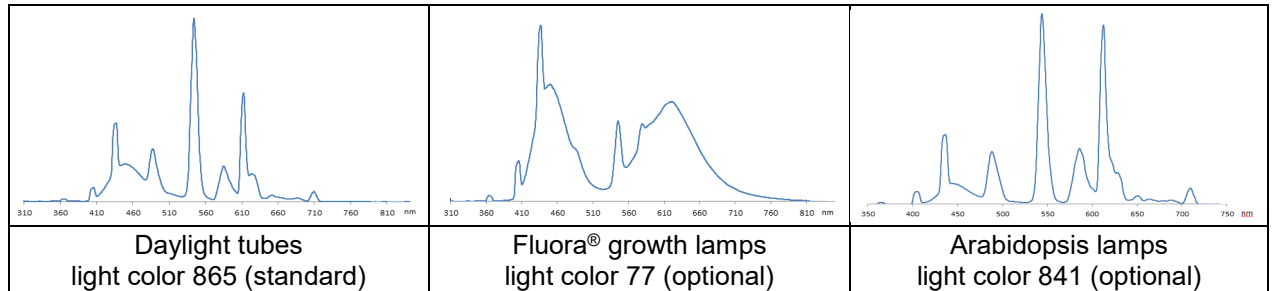

Figure 14: Spectral distribution of fluorescent tubes

Type of fluorescent tube: T8 fluorescent tube in form of a rod with a tube diameter of 26 mm / 1.02 in. Length according to chamber size: 600 mm / 23.6 in (KBW 240, 400), or 900 mm / 35.4 in (KBW 720).



When operating the chamber with illumination: Restricted temperature range 5 °C / 41 °F to 60 °C / 140 °F

18.2 Adjustable light cassettes

Special reflector material in the cassettes ensures optimum light diffusion and efficient utilization of the high light intensity. The lens of the headlight leads to a homogeneous intensity distribution even with a short distance to the shelf. The fluorescent tubes are built in light cassettes that can be freely positioned within wide areas. They homogeneously illuminate the racks below them.

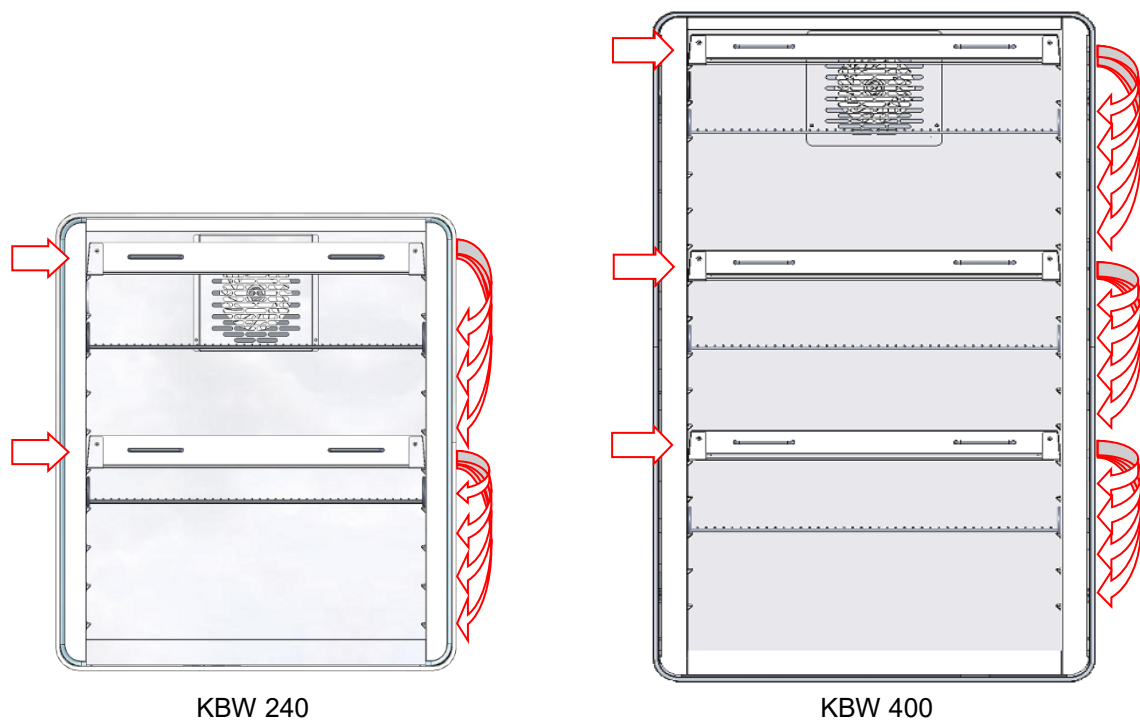

Figure 15: Positions of light cassettes KBW 240 and KBW 400

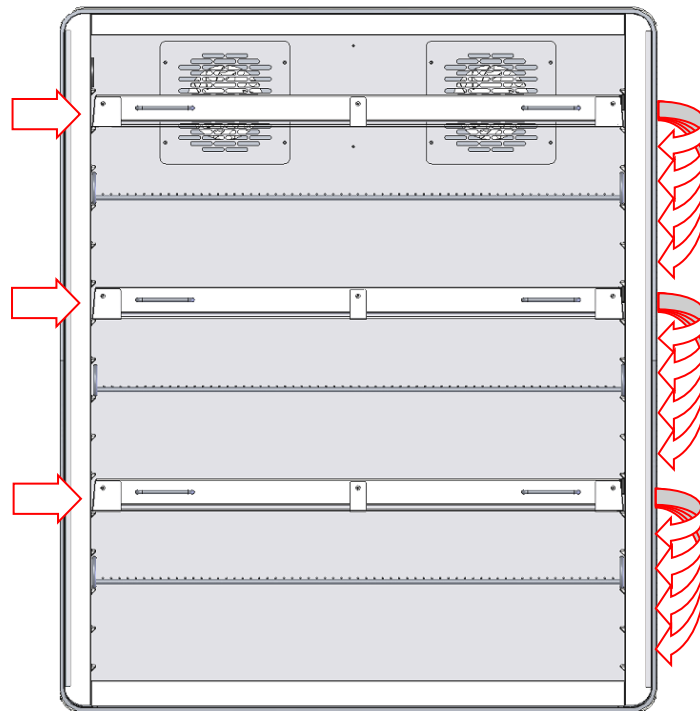

Figure 16: Positions of light cassettes KBW 720



This position is only meant for the light cassettes. Due to their connections, shelves cannot be positioned here.



You can move the light cassettes to the indicated positions.

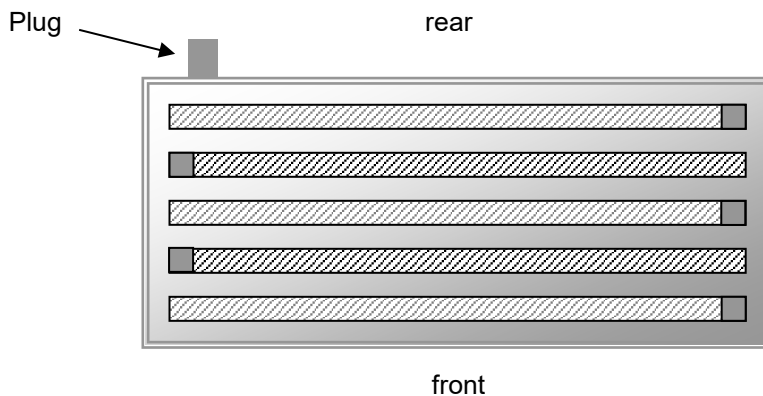

Figure 17: Arrangement of the fluorescent tubes in the light cassette

You will obtain optimum homogeneity by alternately placing the fluorescent tubes of the same type, i.e., opposite arrangement of the inscription:

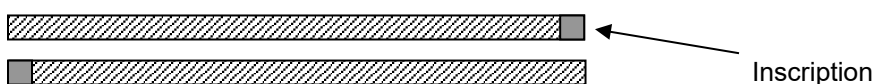



Figure 18: Opposite arrangement of two fluorescent tubes



When replacing the fluorescent tubes, observe tube orientation (inscription).

How to replace the fluorescent tubes is described in chap.21.3.

	Operation with light cassettes and illumination on: Maximum temperature 60 °C / 140 °F.
	Operation with light cassettes and illumination off: Do also NOT operate the chamber at temperatures >60 °C / 140 °F. Otherwise, the lifetime of the fluorescent tubes will be considerably reduced.
	When operating the chamber at temperatures > 60 °C / 140 °F, remove the light cassettes.

18.3 Illumination control

The fluorescent tubes can be turned on and off via operating contacts of the program controller.

For activating the operating contacts please see chap. 7.4, 9.7.3, and 10.6.5.

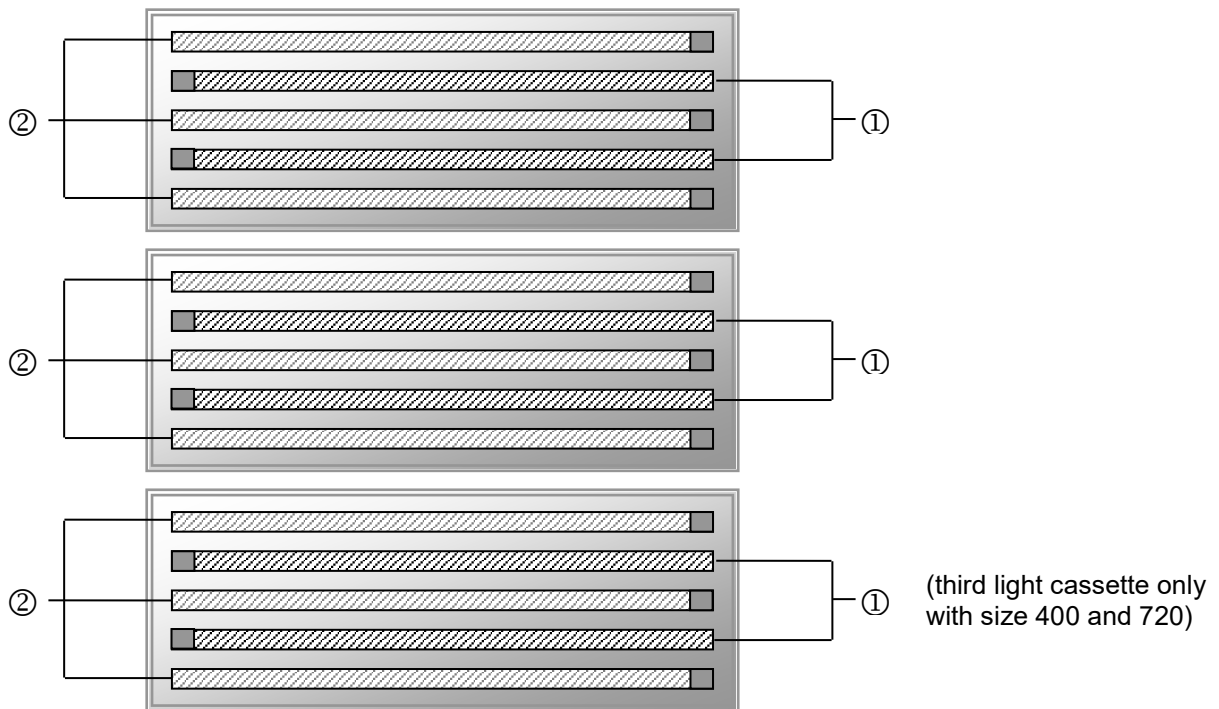



Figure 19: Control of fluorescent tubes in the light cassettes

- ① Control via operation line "Light Level 1"
- ② Control via operation line "Light Level 2"

By switching the operation lines therefore, the following intensities can be obtained:

	Operation line "Light Level 1" Off, operation line "Light Level 2" Off	0 % illumination
①	Operation line "Light Level 1" On, operation line "Light Level 2" Off	40 % illumination
②	Operation line "Light Level 1" Off, operation line "Light Level 2" On	60 % illumination
① ②	Operation line "Light Level 1" On, operation line "Light Level 2" On	100 % illumination

	When operating the chamber with illumination: Restricted temperature range 5 °C / 41 °F to 60 °C / 140 °F,

Note: When operating the chamber without illumination, there is an automatic correction of the actual temperature value when turning on or off the illumination (chap. 7.3).

19. Options

19.1 APT-COM™ 4 Multi Management Software (option)

The chamber is regularly equipped with an Ethernet interface (4) that can connect the APT-COM™ 4 Multi Management Software. The MAC Address is indicated in the "Device info" controller menu (chap. 14.5.2.2). The actual temperature values are given at adjustable intervals. Programming can be performed graphically via PC. Up to 100 chambers can be cross-linked. For further information on networking please refer to the APT-COM™ 4 operating manual.

19.2 RS485 interface (option)

With this option, the chamber is equipped with an additional 2-wire RS485 serial interface (4) that can connect the APT-COM™ 4 Multi Management Software. The actual temperature values are given at adjustable intervals. For further information on networking please refer to the APT-COM™ 4 operating manual.

19.3 Data logger kit (option)

The BINDER Data Logger Kit offers an independent long-term measuring system for temperature, available for different temperature ranges.

The BINDER Data Logger is equipped with a keyboard and a large LCD display, alarm functions and a real-time function. Measurement data are recorded in the Data Logger and can be read out after the measurement via the RS232 interface of the Data Logger. It offers a programmable measuring interval and permits storing up to 64000 measuring values. Reading out is done with the Data Logger evaluation software. You can give out a combined alarm and status protocol directly to a serial printer.

Data Logger Kit T 220: Measuring sensor for the temperature values of the chamber: Temperature range -90 °C / 194 °F up to +220 °C / 428 °F.



For detailed information on installation and operation of the BINDER Data Logger, please refer to the mounting instructions Art. No. 7001-0204 and to the original user manual of the manufacturer, supplied with the data logger.

19.4 Analog outputs for temperature (option)

With this option the chamber is equipped with analog outputs 4-20 mA for temperature. These outputs allow transmitting data to external data registration systems or devices.

The connection is realized as a DIN socket (3) in the right lateral control panel as follows:



ANALOG OUTPUT 4-20 mA DC

PIN 1: Temperature –

PIN 2: Temperature +

Temperature range: -10 °C / 14 °F to +100 °C / 212 °F

A suitable DIN plug is enclosed.

Figure 20: Pin allocation of DIN socket (3) for option analog outputs

19.5 Zero-voltage relay alarm outputs for temperature-(option)

The chamber equipment with optional zero-voltage relay outputs for temperature (option) permits the transmission of alarms to a central monitoring system. Connection is established via a DIN socket (6) located on the right lateral control panel.

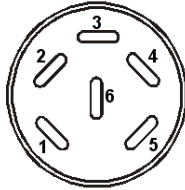
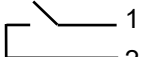
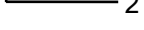



Figure 21: Pin configuration of the DIN socket (6)

Temperature contact	
	1 Pin 1: Pin
	2 Pin 2: Make

In case of a temperature alarm, pins 1 and 2 are open. This happens simultaneously with the alarm message shown on the controller display. In case of power failure, both contacts are open.

Maximum loading capacity of the switching contacts: 24V AC/DC - 2,5A

	 DANGER
	<p>Electrical hazard through overload of contacts.</p> <p>Deadly electric shock. Damage to the switching contacts and connection socket.</p> <ul style="list-style-type: none"> ∅ Do NOT exceed the maximum switching load of 24V AC/DC – 2.5A. ∅ Do NOT connect any devices with a higher loading capacity.

A temperature alarm message will remain visible on the controller display during the whole time of the alarm transmission via the zero-voltage relay outputs.

As soon as the cause of the alarm is rectified, you can reset the alarm transmission via the zero-voltage relay outputs together with the alarm message on the controller.

In case of power failure, transmission of the alarm via zero-voltage relay outputs remains active for the duration of the power failure. Afterwards, both contacts will close automatically.

	<p>When using the APT-COM™ 4 Multi Management Software (option, chap. 19.1) via the Ethernet interface of the chamber for data acquisition, the alarm is not automatically transmitted to the APT-COM™ protocol.</p> <ul style="list-style-type: none"> ➤ Set the tolerance limits for recording limit value excesses separately in APT-COM™ 4.
---	--

19.6 Object temperature display with flexible Pt 100 temperature sensor (option)

The object temperature display enables the determination of the actual temperature of the charging material during the whole process. The object temperature is measured via a flexible Pt100 temperature sensor and can be viewed on the controller display. You can immerse the sensor top protective tube of the flexible Pt 100 into liquid substances.

Fixed value		Setpoint	Actual value
Temperature	°C	25.0	25.0
Obj. Temp.	°C		10.6

Normal display with object temperature display
(sample values)

The object temperature data are put out together with the data of the temperature controller and can be documented by the APT-COM™ 4 Multi Management Software (option, chap. 19.1) developed by BINDER.





Technical data of the Pt100 sensor:

- Three-wire technique
- Class B (DIN EN 60751)
- Temperature range up to 320 °C / 608°F
- Stainless steel protective tube with a length of 45 mm / 1.78 in, material no. 1.4501

20. Cleaning and decontamination

Clean the chamber after each use in order to prevent potential corrosion damage by ingredients of the loading material.

Prior to renewed startup, allow the chamber to completely dry after all cleaning and decontamination measures.

  	 DANGER
	<p>Electrical hazard by water entering the chamber.</p> <p>Deadly electric shock.</p>
	<ul style="list-style-type: none"> Ø Do NOT spill water or cleaning agents over the inner and outer chamber surfaces. Ø Do NOT put ANY cleaning aids (cloth or brush) into slots or openings on the chamber. ➤ Before cleaning, turn off the chamber at the main power switch and disconnect the power plug. Let the chamber cool down to ambient temperature. ➤ Completely dry the chamber before turning it on again.

20.1 Cleaning

Disconnect the chamber from the power supply before cleaning. Disconnect the power plug.

	<p>The interior of the chamber must be kept clean. Thoroughly remove any residues of test material.</p>
---	---

Wipe the surfaces with a moistened towel. In addition, you can use the following cleaning agents:

Exterior surfaces inner chamber racks door gaskets	Standard commercial cleaning detergents free from acid or halides. Alcohol-based solutions. We recommend using the neutral cleaning agent Art. No. 1002-0016.
Instrument panel	Standard commercial cleaning detergents free from acid or halides. We recommend using the neutral cleaning agent Art. No. 1002-0016.
Zinc coated hinge parts rear chamber wall	Standard commercial cleaning detergents free from acid or halides. Do NOT use a neutral cleaning agent on zinc coated surfaces.

Do not use cleaning agents that may cause a hazard due to reaction with components of the device or the charging material. If there is doubt regarding the suitability of cleaning products, please contact BINDER service.

	<p>We recommend using the neutral cleaning agent Art. No. 1002-0016 for a thorough cleaning.</p> <p>Any corrosive damage that may arise following use of other cleaning agents is excluded from liability by BINDER GmbH.</p> <p>Any corrosive damage caused by a lack of cleaning, is excluded from liability by BINDER GmbH.</p>
---	--

	NOTICE
	<p>Danger of corrosion by using unsuitable cleaners.</p> <p>Damage to the chamber.</p> <ul style="list-style-type: none"> ∅ Do NOT use acidic or chlorine cleaning detergents. ∅ Do NOT use a neutral cleaning agent on other kind of surfaces e.g., the zinc coated hinge parts or the rear chamber wall.

	<p>For surface protection, perform cleaning as quickly as possible.</p> <p>After cleaning completely remove cleaning agents from the surfaces with a moistened towel. Let the chamber dry.</p>
---	--







	<p>Soapsuds may contain chlorides and must therefore NOT be used for cleaning.</p>
---	--

	<p>With every cleaning method, always use adequate personal safety controls.</p>
---	--

Following cleaning, leave the chamber door open or remove the access port plugs.

	<p>The neutral cleaning agent may cause health problems in contact with skin and if ingested. Follow the operating instructions and safety hints labeled on the bottle of the neutral cleaning agent.</p>
--	---

Recommended precautions: To protect the eyes use sealed protective goggles. Wear gloves. Suitable protective gloves in full contact with media: butyl or nitrile rubber, penetration time >480 minutes.

 	 CAUTION
 	<p>Danger of chemical burns through contact with skin or ingestion of the neutral cleaning agent.</p> <p>Skin and eye damage. Environmental damage.</p> <ul style="list-style-type: none"> ∅ Do not ingest the neutral cleaning agent. Keep it away from food and beverages. ∅ Do NOT empty the neutral cleaning agent into drains. ➤ Wear protective gloves and goggles. ➤ Avoid skin contact with the neutral cleaning agent.
	

20.2 Decontamination / chemical disinfection

The operator must ensure that proper decontamination is performed in case a contamination of the chamber by hazardous substances has occurred.

Disconnect the chamber from the power supply prior to chemical decontamination. Pull the power plug.

Do not use decontamination agents that may cause a hazard due to reaction with components of the device or the charging material. If there is doubt regarding the suitability of cleaning products, please contact BINDER service.

You can use the following disinfectants:

Inner chamber	Standard commercial surface disinfectants free from acid or halides. Alcohol-based solutions. We recommend using the disinfectant spray Art. No. 1002-0022.
---------------	---

	For chemical disinfection, we recommend using the disinfectant spray Art. No. 1002-0022. Any corrosive damage that may arise following use of other disinfectants is excluded from liability by BINDER GmbH.
---	---



	With every decontamination / disinfection method, always use adequate personal safety controls.
---	---

In case of contamination of the interior by biologically or chemically hazardous material, there are two possible procedures depending on the type of contamination and charging material:

1. Spray the inner chamber with an appropriate disinfectant.
Before start-up, the chamber must be absolutely dry and ventilated, as explosive gases may form during the decontamination process.
2. If necessary, have strongly contaminated inner chamber parts removed by an engineer for cleaning, or have them exchanged. Sterilize the inner chamber parts in a sterilizer or autoclave.

	In case of eye contact, the disinfectant spray may cause eye damage due to chemical burns. Follow the operating instructions and safety hints labeled on the bottle of the disinfectant spray.
---	--

Recommended precautions: To protect the eyes use sealed protective goggles.

	 CAUTION
	<p>Danger of chemical burns through eye contact with the disinfectant spray.</p> <p>Eye damage. Environmental damage</p> <ul style="list-style-type: none"> ⊘ Do NOT empty the disinfectant into drains. ➤ Wear protective goggles.

	After using the disinfectant spray, allow the chamber to dry thoroughly, and aerate it sufficiently.
---	--

21. Maintenance and service, troubleshooting, repair, testing

21.1 General information, personnel qualification

- **Maintenance**

See chap. 21.2

- **Simple troubleshooting**

Chap. 21.4 describes troubleshooting by operating personnel. It does not require technical intervention into the chamber, nor disassembly of chamber parts.

For personnel requirements please refer to chap. 1.1.

- **Detailed troubleshooting**

If errors cannot be identified with simple troubleshooting, further troubleshooting must be performed by BINDER Service or by BINDER qualified service partners or technicians, in accordance with the description in the Service Manual.

For personnel requirements please refer to the Service Manual.

- **Repair**

Repair of the chamber can be performed by BINDER Service or by BINDER qualified service partners or technicians, in accordance with the description in the Service Manual.



After maintenance, the chamber must be tested prior to resuming operation.

- **Electrical testing**

To prevent the risk of electrical shock from the electrical equipment of the chamber, an annual repeat inspection as well as a test prior to initial startup and prior to resuming operation after maintenance or repair, are required. This test must meet the requirements of the competent public authorities. We recommend testing under DIN VDE 0701-0702:2008 in accordance with the details in the Service Manual.

For personnel requirements please refer to the Service Manual.

21.2 Maintenance intervals, service

 	<div style="background-color: red; color: white; padding: 5px; text-align: center;">  DANGER </div> <p>Electrical hazard during live maintenance work.</p> <p>Deadly electric shock.</p> <ul style="list-style-type: none"> ∅ The chamber must NOT become wet during operation or maintenance works. ∅ Do NOT remove the rear panel of the chamber. ➤ Disconnect the chamber before conducting maintenance work. Turn off the main power switch and pull the power plug. ➤ Make sure that general maintenance work will be conducted by licensed electricians or experts authorized by BINDER. ➤ Make sure that maintenance work at the refrigeration system will only be conducted by qualified personnel who underwent training in accordance with EN 13313:2010 (e.g. a refrigeration technician with certified expert knowledge acc. to Regulation (EC) n° 303/2008). Follow the national statutory regulations.
--	---

Ensure regular maintenance work is performed at least once a year and that the legal requirements are met regarding the qualifications of service personnel, scope of testing and documentation. All work on the refrigeration system (repairs, inspections) must be documented.



The warranty becomes void if maintenance work is conducted by non-authorized personnel.



Replace the door gasket only when cold. Otherwise, the door gasket may become damaged.

With an increased amount of dust in the ambient air, clean the condenser fan (by suction or blowing) several times a year.

We recommend taking out a maintenance agreement. Please consult BINDER Service:

BINDER telephone hotline:	+49 (0) 7462 2005 555
BINDER fax hotline:	+49 (0) 7462 2005 93555
BINDER e-mail hotline:	customerservice@binder-world.com
BINDER service hotline USA:	+1 866 885 9794 or +1 631 224 4340 x3 (toll-free in the USA)
BINDER service hotline Asia Pacific:	+852 390 705 04 or +852 390 705 03
BINDER service hotline Russia and CIS	+7 495 988 15 16
BINDER Internet website	http://www.binder-world.com
BINDER address	BINDER GmbH, post office box 102, 78502 Tuttlingen, Germany

International customers, please contact your local BINDER distributor.

After 8760 operating hours or two years the following message appears:

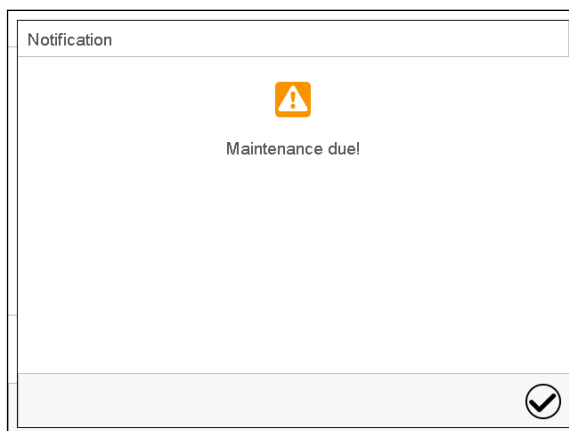

After confirmation with the **Confirm** icon, the message window will pop up again every two weeks until it is reset by BINDER Service.

21.3 Replacement of the fluorescent tubes

The average life expectancy of the fluorescent tubes is about 10,000 hours. We recommend replacing the tubes every year in order to ensure full light intensity.

To replace the fluorescent tubes, unscrew and remove the clamping strips resting against the glass plate (Allen screwdriver). Then lift the plate from the cassette. Rotate the tubes by 90° and pull them out of their holders. When setting in the new tubes, observe the tube orientation (inscription, Figure 18). Fix the glass plate and then screw in the clamping strips.

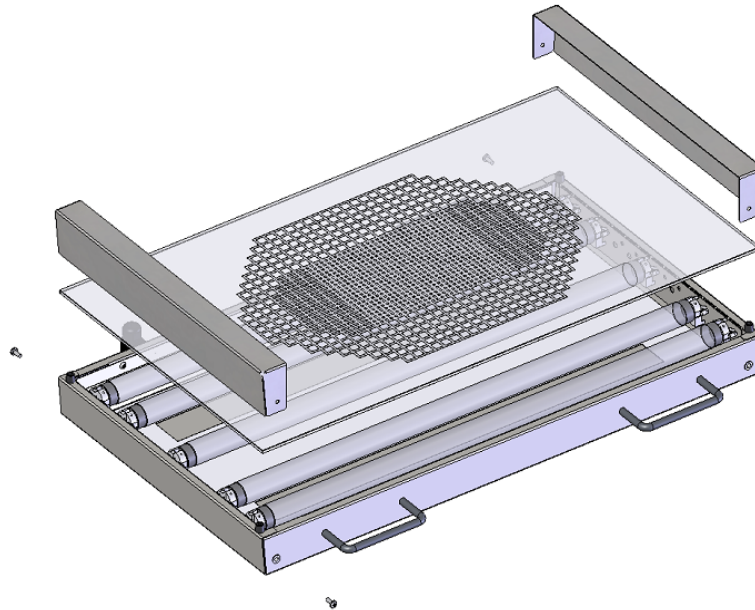

Figure 22: Dismounting a light cassette



Always replace all the fluorescent tubes of a light cassette together. Otherwise, homogeneity of light intensity cannot be ensured.

21.4 Simple troubleshooting

Defects and shortcomings can compromise the operational safety of the chamber and can lead to risks and damage to equipment and persons. If there is a technical fault or shortcoming, take the chamber out of operation and inform BINDER Service. If you are not sure whether there is a technical fault, proceed according to the following list. If you cannot clearly identify an error or there is a technical fault, please contact BINDER Service.



Only qualified service personnel authorized by BINDER must perform repair. Repaired chambers must comply with the BINDER quality standards.

Fault description	Possible cause	Required measures
General		
Chamber without function.	No power supply.	Check connection to power supply. Check whether the chamber is turned on at the main power switch.
	Wrong voltage.	Check power supply for correct voltage (chap. 4.4).
	Chamber fuse has responded.	Check chamber fuse and replace it if appropriate. If it responds again, contact BINDER service.
	Controller defective.	Contact BINDER service.
	Nominal temperature exceeded by 10° due to chamber failure. Over temperature protective device (class 1) responds.	

Fault description	Possible cause	Required measures
Heating		
Chamber heating permanently, set-point not maintained.	Controller defective.	Contact BINDER service.
	Semiconductor relay defective.	
	Controller not well adjusted, or adjustment interval exceeded.	Calibrate and adjust controller.
Chamber doesn't heat up.	Pt 100 sensor defective.	Contact BINDER service.
	Heating element defective.	
	Semiconductor relay defective	
Chamber doesn't heat up when turned on. Safety controller responds.	Inner chamber temperature has reached the safety controller set-point. Safety controller set too low.	Acknowledge the alarm on the controller. Check temperature setpoint setting. If appropriate, select suitable safety controller setpoint (chap. 12.2).
	Safety controller (chap. 12.2) defective.	Contact BINDER service.
Mechanical safety device class 3.1 responds (with option safety device class 3.3).	Limit temperature reached.	Acknowledge the alarm on the controller. Check setting of temperature set-point and safety device class 3.1. If appropriate, select suitable limit value.
	Too much external heat load.	Reduce heat load.
	Controller defective.	Contact BINDER service.
	Safety device defective.	
Mechanical safety device class 3.2 responds (with option safety device class 3.3).	Limit temperature reached.	Acknowledge the alarm on the controller. Check setting of temperature set-point and safety device class 3.2. If appropriate, select suitable limit value.
	Controller or safety device defective.	Contact BINDER service.
	Low temperature accuracy	Fan speed has been reduced.
Refrigerating performance		
Low or no refrigerating performance.	Ambient temperature > 25 °C / 77 °F (chap.3.4).	Select cooler place of installation.
	Compressor not turned on.	Contact BINDER service.
	Electro-valves defective.	
	No or not enough refrigerant.	Reduce heat load.
Too much external heat load.		
Icing at the evaporator plates.	Set-point was too long-below ambient temperature.	Defrost the chamber (chap. 17).
Condensation at the walls of the inner chamber.	Set-point was too long below ambient temperature, icing in the preheating chamber.	Defrost the chamber (chap. 17)
Controller		
No chamber function (dark display).	Display in standby mode.	Press on touchscreen.
	Main power switch turned off.	Turn on the main power switch.
Menu functions not available.	Menu functions not available with current authorization level.	Log in with the required higher authorization or contact BINDER service to obtain an activation code (chap. 13.6).

Fault description	Possible cause	Required measures
Controller (continued)		
No access to controller	Password incorrect.	Contact BINDER service.
Chart recorder function: measured-value memory cleared; information lost.	New setting of storage rate or scaling (minimum and/or maximum) (chap. 16.2).	Change the storage rate or scaling ONLY if the previously registered data are no longer required.
Controller does not equilibrate to setpoints entered in Fixed value operation mode	Controller is not in Fixed value operation mode.	Change to Fixed value operation mode.
Controller does not equilibrate to program set-points.	Controller is not in program operation mode, or program delay time is running.	Start the program again. If appropriate, wait for the program delay time.
Program duration longer than programmed.	Tolerances have been programmed.	For rapid transition phases, do NOT program tolerance limits in order to permit maximum heating or refrigerating speed.
Program keeps the last program setpoint constant while in setting "ramp".	Program line with setting "ramp" is incomplete.	When programming with setting "ramp", define the end value of the desired cycle by adding an additional section with a section time of at least one second.
Ramp temperature transitions are only realized as steps.	Setting "step" has been selected.	Select setting "ramp".
Acknowledging the alarm does not cancel the alarm state.	Cause of alarm persists.	Remove cause of alarm. If the alarm state continues, contact BINDER service.
Alarm message: ---- or <-<-< or >->->	Sensor rupture between sensor and controller or Pt 100 sensor defective.	Contact BINDER service.
	Short-circuit.	
Miscellaneous		
Fluorescent tube does not illuminate.	Defective fluorescent tube.	Replace all fluorescent tubes of the light cassette.

21.5 Sending the chamber back to BINDER GmbH

If you return a BINDER product to us for repair or any other reason, we will only accept the product upon presentation of an **authorization number** (RMA number) that has previously been issued to you. An authorization number will be issued after receiving your complaint either in writing or by telephone **prior** to your sending the BINDER product back to us. The authorization number will be issued following receipt of the information below:

- BINDER product type and serial number
- Date of purchase
- Name and address of the dealer from which you bought the BINDER product
- Exact description of the defect or fault
- Complete address, contact person and availability of that person
- Exact location of the BINDER product in your facility
- A contamination clearance certificate (chap. 26) must be faxed in advance

The authorization number must be applied to the packaging in such a way that it can be easily recognized or be recorded clearly in the delivery documents.



For security reasons we cannot accept a chamber delivery if it does not carry an authorization number.

Return address: BINDER GmbH Gänsäcker 16
Abteilung Service 78502 Tuttlingen, Germany

22. Disposal

22.1 Disposal of the transport packing

Packing element	Material	Disposal
Straps to fix packing on pallet	Plastic	Plastic recycling
Wooden transport box (option) with metal screws	Non-wood (compressed match-wood, IPPC standard)	Wood recycling
	Metal	Metal recycling
Pallet with foamed plastic stuffing	Solid wood (IPPC standard)	Wood recycling
	PE foam	Plastic recycling
Transport box with metal clamps	Cardboard	Paper recycling
	Metal	Metal recycling
Top cover	Cardboard	Paper recycling
Edge protection	Styropor® or PE foam	Plastic recycling
Protection of doors and racks	PE foam	Plastic recycling
Bag for operating manual	PE foil	Plastic recycling
Insulating air cushion foil (packing of optional accessories)	PE foil	Plastic recycling

If recycling is not possible, all packing parts can also be disposed of with normal waste.

22.2 Decommissioning

Turn off the chamber at the main power switch (1) and disconnect it from the power supply (pull the power plug).

- Temporal decommissioning: See indications for appropriate storage, chap. 3.3.
- Final decommissioning: Dispose of the chamber as described in chap. 22.3 to 22.5.

22.3 Disposal of the chamber in the Federal Republic of Germany

According to Annex I of Directive 2012/19/EU of the European Parliament and of the Council on waste electrical and electronic equipment (WEEE), BINDER devices are classified as “monitoring and control instruments” (category 9) only intended for professional use”. They must not be disposed of at public collecting points.

The chambers bear the symbol for the marking of electrical and electronic equipment manufactured / placed on the market in the EU after 13 August 2005 and be disposed of in separate collection according to Directive 2012/19/EU on waste electrical and electronic equipment (WEEE) and German national law for electrical and electronic equipment (Elektro- und Elektronikgerätegesetz, ElektroG). WEEE marking: crossed-out wheeled bin with solid bar under. A significant part of the materials must be recycled in order to protect the environment.

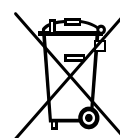



At the end of the device's service life, have the chamber disposed of according to the German national law for electrical and electronic equipment (Elektro- und Elektronikgerätegesetz, ElektroG from 20 October 2015, BGBl. I p. 1739) or contact BINDER service who will organize taking back and disposal of the chamber according to the German national law for electrical and electronic equipment (Elektro- und Elektronikgerätegesetz, ElektroG from 20 October 2015, BGBl. I p. 1739).

	NOTICE
	<p>Danger of violation against existing law if not disposed of properly.</p> <p>Failure to comply with applicable law.</p> <ul style="list-style-type: none"> ⊘ Do NOT dispose of BINDER devices at public collecting points. ➤ Have the device disposed of professionally at a recycling company which is certified according to the German national law for electrical and electronic equipment (Elektro- und Elektronikgerätegesetz, ElektroG from 20 October 2015, BGBl. I p. 1739). <p style="text-align: center;"><i>or</i></p> <ul style="list-style-type: none"> ➤ Instruct BINDER Service to dispose of the device. The general terms of payment and delivery of BINDER GmbH apply, which were valid at the time of purchasing the chamber.

Certified companies disassemble waste (used) BINDER equipment in primary substances for recycling according to Directive 2012/19/EU. The devices must be free from toxic, infectious or radioactive substances in order to eliminate any health hazards to the employees of the recycling companies.

	<p>Prior to handing the chamber over to a recycling company, it is the user's responsibility that it is free from toxic, infectious or radioactive substances.</p> <ul style="list-style-type: none"> • Prior to disposal, clean all introduced or residual toxic substances from the chamber. • Prior to disposal, disinfect the chamber from all sources of infection. Be aware that sources of infection may also be located outside the inner chamber. • If you cannot safely remove all toxic substances and sources of infection from the chamber, dispose of it as special waste according to national law. • Fill out the contamination clearance certificate (chap. 26) and enclose it with the chamber.
---	---

 	 WARNING
<p>Danger of intoxication and infection through contamination of the chamber with toxic, infectious or radioactive substances.</p> <p>Damages to health.</p> <ul style="list-style-type: none"> Ø NEVER take a chamber contaminated with toxic substances or sources of infection for recycling according to Directive 2012/19/EU. ➤ Prior to disposal, remove all toxic substances and sources of infection from the chamber. ➤ A chamber from which all toxic substances or sources of infection cannot be safely removed must be considered as “special” waste according to national law. Dispose of it accordingly. 	

The refrigerant used R 134A (1,1,1,2-tetrafluorethane) is not inflammable at ambient pressure. It must not escape into the environment. In Europe, recovery of the refrigerant R 134A (1300) is mandatory according to regulation No. 842/2006/EC. Ensure the compliance with the applicable legal requirements regarding qualification of staff, disposal, and documentation.

As the end user, you are legally obliged to return used batteries. Old batteries and rechargeable batteries must not be disposed of with household waste. They can be handed in free of charge at the community's public collection points and wherever batteries and accumulators of the type in question are sold.

22.4 Disposal of the chamber in the member states of the EU except for the Federal Republic of Germany

According to Annex I of Directive 2012/19/EU of the European Parliament and of the Council on waste electrical and electronic equipment (WEEE), BINDER devices are classified as “monitoring and control instruments” (category 9) only intended for professional use”. They must not be disposed of at public collecting points.

The chambers bear the symbol for the marking of electrical and electronic equipment manufactured / placed on the market in the EC after 13 August 2005 and be disposed of in separate collection according to the Directive 2012/19/EU on waste electrical and electronic equipment (WEEE). WEEE marking: crossed-out wheeled bin with solid bar under.

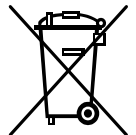



At the end of the device's service life, notify the distributor who sold you the device, who will take back and dispose of the chamber according to the Directive 2012/19/EU on waste electrical and electronic equipment (WEEE).

	NOTICE
<p>Danger of violation against existing law if not disposed of properly.</p> <p>Failure to comply with applicable law.</p> <ul style="list-style-type: none"> Ø Do NOT dispose of BINDER devices at public collecting points. ➤ Have the device disposed of professionally at a recycling company, which is certified according to conversion of the Directive 2012/19/EU into national law. <i>or</i> ➤ Instruct the distributor who sold you the device to dispose of it. The agreements apply that were agreed with the distributor when purchasing the chamber (e.g. his general terms of payment and delivery). ➤ If your distributor is not able to take back and dispose of the chamber, please contact BINDER service. 	

Certified companies disassemble waste (used) BINDER equipment in primary substances for recycling according to Directive 2012/19/EU. The devices must be free from toxic, infectious or radioactive substances in order to eliminate any health hazards to the employees of the recycling companies.



	<p>Prior to handing the chamber over to a recycling company, it is the user's responsibility that it is free from toxic, infectious or radioactive substances.</p> <ul style="list-style-type: none"> • Prior to disposal, clean all introduced or residual toxic substances from the chamber. • Prior to disposal, disinfect the chamber from all sources of infection. Be aware that sources of infection may also be located outside the inner chamber. • If you cannot safely remove all sources of infection and toxic substances from the chamber, dispose of it as special waste according to national law. • Fill out the contamination clearance certificate (chap. 26) and enclose it with the chamber.
---	---

	<p style="text-align: center;">WARNING</p>
	<p>Danger of intoxication and infection through contamination of the chamber with toxic, infectious or radioactive substances.</p> <p>Damages to health.</p> <ul style="list-style-type: none"> Ø NEVER take a chamber contaminated with toxic substances or sources of infection for recycling according to Directive 2012/19/EU. ➤ Prior to disposal, remove all toxic substances and sources of infection from the chamber. ➤ A chamber from which all toxic substances or sources of infection cannot be safely removed must be considered as "special" waste according to national law. Dispose of it accordingly.

The refrigerant used R 134A (1,1,1,2-tetrafluoroethane) is not inflammable at ambient pressure. It must not escape into the environment. In Europe, recovery of the refrigerant R 134A (1300) is mandatory according to regulation No. 842/2006/EC. Ensure the compliance with the applicable legal requirements regarding qualification of staff, disposal, and documentation.

The disposal of batteries within the EU must be carried out in accordance with the current EU directives as well as national, regional and local environmental protection regulations.

22.5 Disposal of the chamber in non-member states of the EU

	<p style="text-align: center;">NOTICE</p>
	<p>Danger of violation against existing law if not disposed of properly.</p> <p>Failure to comply with applicable law. Alteration of the environment.</p> <ul style="list-style-type: none"> ➤ For final decommissioning and disposal of the chamber, please contact BINDER service. ➤ Follow the statutory regulations for appropriate, environmentally friendly disposal.

The main board of the chamber includes a lithium cell. Used batteries must be disposed of properly. Please ensure that you dispose of the battery in accordance with the regulations in force in your country.

The refrigerant used R 134A (1,1,1,2-tetrafluoroethane) is not inflammable at ambient pressure. It must not escape into the environment. In Europe, recovery of the refrigerant R 134A (1300) is mandatory according to regulation No. 842/2006/EC. Ensure the compliance with the applicable legal requirements regarding qualification of staff, disposal, and documentation.

23. Technical description

23.1 Factory calibration and adjustment

The chambers were calibrated and adjusted in the factory. Calibration and adjustment were performed using standardized test instructions, according to the QM DIN EN ISO 9001 system applied by BINDER (certified since December 1996 by TÜV CERT). All test equipment used is subject to the administration of measurement and test equipment that is also a constituent part of the BINDER QM DIN EN ISO 9001 systems. They are controlled and calibrated to a DKD-Standard at regular intervals.



Repeated calibrations are recommended in periods of 12 months.

23.2 Over current protection

The chambers are equipped with an internal fuse not accessible from outside. If this fuse is blown, please contact an electronic engineer or BINDER service.

23.3 Definition of usable volume

The usable volume illustrated below is calculated as follows:

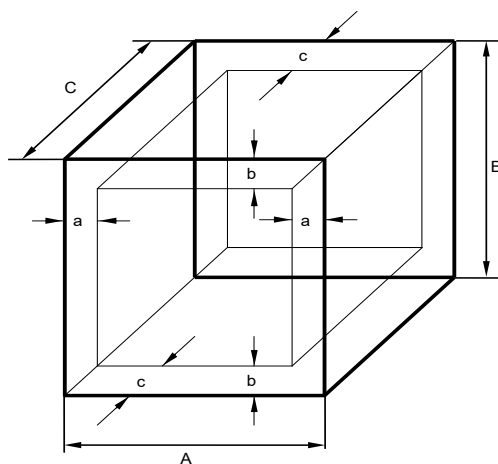

A, B, C = internal dimensions (W, H, D)

a, b, c = distance to wall

$$a = 0.1 \cdot A$$

$$b = 0.1 \cdot B$$

$$c = 0.1 \cdot C$$

$$V_{USE} = (A - 2 \cdot a) \cdot (B - 2 \cdot b) \cdot (C - 2 \cdot c)$$

Figure 23: Determination of the usable volume

The technical data refers to the defined usable volume.



Do NOT place samples outside this usable volume.

Do NOT load this volume by more than half to enable sufficient airflow inside the chamber.

Do NOT divide the usable volume into separate parts with large area samples.

Do NOT place samples too close to each other in order to permit circulation between them and thus obtain a homogenous distribution of temperature.

23.4 Technical Data

Chamber size		240	400	720
Exterior dimensions				
Width, net	mm / inch	925 / 36.42	925 / 36.42	1250 / 49.21
Height, gross (incl. castors)	mm / inch	1460 / 57.48	1945 / 76.57	1925 / 75.79
Depth, net	mm / inch	800 / 31.50	800 / 31.50	890 / 35.04
Depth, gross (incl. door handle, control panel, connection and 30 mm for cable)	mm / inch	880 / 34.65	880 / 34.65	970 / 38.20
Wall clearance rear (minimum) (spacers)	mm / inch	100 / 3.94	100 / 3.94	100 / 3.94
Wall clearance side (minimum)	mm / inch	160 / 6.29	160 / 6.29	160 / 6.29
Doors				
Quantity of doors		1	1	2
Quantity of inner glass doors		1	1	2
Interior dimensions				
Width	mm / inch	650 / 25.59	650 / 25.59	970 / 38.19
Height	mm / inch	785 / 30.90	1270 / 50.00	1250 / 49.21
Depth	mm / inch	485 / 19.09	485 / 19.09	576 / 22.68
Interior volume	l / cu.ft.	247 / 8.7	400 / 14.1	698 / 24.6
Steam space volume	l / cu.ft.	348 / 12.3	564 / 19.3	918 / 32.4
Racks				
Quantity of racks (regular)		2	3	3
Quantity of racks (max.)		9	12	12
Quantity of light cassettes		2	3	3
Maximum load per rack	kg / lbs	30 / 66	30 / 66	45 / 99
Maximum permitted total load	kg / lbs	100 / 220	120 / 265	150 / 331
Weight				
Weight (empty)	kg / lbs	195 / 430	252 / 556	359 / 791
Temperature data without illumination				
Temperature range	°C / °F	0 to +70 / 32 to 158	0 to +70 / 32 to 158	0 to +70 / 32 to 258.2
Temperature fluctuation	+/- K	0.1	0.1	0.1
Temperature uniformity (variation)	+/- K	0.5	0.5	0.5
Max. heat compensation at 40 °C / 104°F	W	450	600	750
Temperature data with 100% light intensity				
Temperature range	°C / °F	+5 to +60 / 41 to 140	+5 to +60 / 41 to 140	+5 to +60 / 41 to 140
Temperature fluctuation	+/- K	0.2	0.2	0.1
Temperature uniformity (variation)	+/- K	0.5	1.5	1.0
Max. heat compensation at 40 °C / 104°F	W	300	450	500
Illumination data per light cassette				
Daylight fluorescent tubes	Lux	9,000	9,000	13,000
	W/m ²	24	24	38
Fluora® growth lamps	Lux	7,500	7,500	10,500
	W/m ²	23	23	36
Arabidopsis lamps	Lux	11,000	11,000	14,000
	W/m ²	32	32	43

Chamber size		240	400	720	
Electrical data					
System of housing protection acc. to EN 60529		IP	20	20	20
Nominal voltage (+/-10%)	at 50 Hz power frequency	V	200-230	200-230	200-230
	at 60 Hz power frequency	V	---	200-230	200-230
Current type			1N~	1N~	1N~
Power plug			shock proof plug		
Nominal power		kW	1.40	1.60	2.70
Overvoltage category acc. to IEC 61010-1			II	II	II
Pollution degree acc. to IEC 61010-1			2	2	2
Over-current release category B, 2 poles		Amp	16 internal	16 internal	16 internal
Environment-specific data					
Noise level (mean value)		dB (A)	53	54	59
Energy consumption without illumination	at 0 °C / 32 °F	Wh/h	≤ 290	≤ 380	≤ 480
	at 5 °C / 41 °F	Wh/h	≤ 440	≤ 610	≤ 860
Energy consumption with 100% light intensity	at 25 °C / 77 °F	Wh/h	≤ 440	≤ 620	≤ 870
	at 37 °C / 98.6 °F	Wh/h	≤ 450	≤ 620	≤ 880
Filling weight of refrigerant R 134A (GWP 1300)		kg	0,270	0,300	0,500

Illumination data: Average value, measured at +22 °C +/- 3°C / 71.6 °F +/- 5.4 °F with a spherical sensor (+/- 10%) 12 cm / 4.7 in below the light cassette. The values given in W/m² refer to global radiation.

All technical data is specified for unloaded chambers with standard equipment at an ambient temperature of +22 °C +/- 3°C / 71.6 °F +/- 5.4 °F and a power supply voltage fluctuation of +/-10%. Technical data is determined in accordance to BINDER factory standard Part 2:2015 and DIN 12880:2007.

All indications are average values, typical for chambers produced in series. We reserve the right to change technical specifications at any time.



If the chamber is fully loaded, the specified heating up and cooling down times may vary according to the load.

23.5 Equipment and options (extract)



To operate the chamber, use only original BINDER accessories or accessories / components from third-party suppliers authorized by BINDER. The user is responsible for any risk arising from using unauthorized accessories.

Regular equipment
Microprocessor display program controller with digital display and touchscreen
Ethernet interface for computer communication
Temperature safety device class 3.1 acc. to DIN 12880:2007
Inner glass door with gasket
DCT™ refrigerating system with refrigerant R134a
Four castors (2 lockable)
2 racks, stainless steel
Access port 30 mm with silicone plug
Illumination system: Daylight illumination tubes light color 865. 2 (KBW 240) resp. 3 (KBW 400, 700) light cassettes

Options / accessories
Additional rack, stainless steel
Perforated shelf, stainless steel
Reinforced rack with rack lockings
Securing elements for additional fastening of racks (4 pieces)
Light cassette
Set of fluorescent tubes daylight (light color 865), for 1 light cassette
Set of fluorescent tubes Fluora® (light color 77) replacing the daylight fluorescent tubes, for 1 light cassette
Set of fluorescent tubes for Arabidopsis (light color 841) replacing the daylight fluorescent tubes, for 1 light cassette
Temperature safety device class 3.3 acc. to DIN 12880:2007
Zero-voltage relay alarm outputs for temperature with DIN plug 6-poles
Lockable door
Access ports 30 mm or 50 mm or 100 mm with silicone plug
Analog outputs 4-20 mA for temperature with 6 pole DIN socket, DIN plug included
Object temperature display with flexible Pt 100 temperature sensor
Communication interface RS485
BINDER Data Logger kit T 220
Calibration of temperature including certificate
Spatial temperature measurement including certificate
Spatial temperature measurement acc. to DIN 12880:2007 including certificate
Illumination measurement certificate: Radiometrical measurement with documentation of intensity distribution and of qualitative spectral distribution
Qualification folder

23.6 Accessories and spare parts (extract)



BINDER GmbH is responsible for the safety features of the chamber only, provided skilled electricians or qualified personnel authorized by BINDER perform all maintenance and repair, and if components relating to chamber safety are replaced in the event of failure with original spare parts. The user is responsible for any risks arising from using unauthorized accessories/components.

Chamber size	240	400	720
Description	Art. no.		
Shelf, stainless steel	6004-0101	6004-0101	6004-0106
Perforated shelf, stainless steel	6004-0040	6004-0040	8009-0486
Perforated rack with additional fixation for shaker operation	8012-0639	8012-0639	8012-0673
Reinforced rack with rack lockings	8012-0638	8012-0638	8012-0674
Rack lockings (4 pieces)	8012-0620	8012-0620	8012-0620
Door gasket silicone (kettle)	6005-0147	6005-0212	6005-0196
Door gasket silicone (outer door)	6005-0161	6005-0211	6005-0197
Intermediate door gasket silicone	---	---	6005-0192
Light cassette	8009-0663	8009-0663	8009-0661

Chamber size	240	400	720
Description	Art. no.		
Set fluorescent tubes daylight (light color 865), for 1 light cassette	8500-0024	8500-0024	8500-0025
Set fluorescent tubes Fluora® (light color 77) replacing the daylight fluorescent tubes, for 1 light cassette	8500-0022	8500-0022	8500-0026
Set fluorescent tubes for Arabidopsis (light color 841) replacing the daylight fluorescent tubes, for 1 light cassette	8500-0023	8500-0023	8500-0027
Replacement glass for light cassette	8010-0085	8010-0085	8010-0087

Description	Art. no.
Plug for silicon access port d30	6016-0035
Data Logger Kit T 220	8012-0715
Neutral cleaning agent, 1 kg	1002-0016
Flexible tilt protection kit for KBW 400	8009-0828

Validation service	Art. no.
Qualification folder IQ-OQ (printed version)	7007-0003
Qualification folder IQ-OQ (digital version)	7057-0003
Qualification folder IQ-OQ-PQ (printed version)	7007-0007
Qualification folder IQ-OQ-PQ (digital version)	7057-0007
Execution of IQ-OQ	DL430400
Execution of IQ-OQ-PQ	DL440500

Calibration service	Art. no.
Calibration of temperature including certificate (1 measuring point)	DL300101
Spatial temperature measurement including certificate (9 measuring points)	DL300109
Spatial temperature measurement including certificate (18 measuring points)	DL300118
Spatial temperature measurement including certificate (27 measuring points)	DL300127
Illumination measurement including certificate: 25 measuring points, intensity measurement with documentation of intensity distribution and of qualitative spectral distribution	DL310000

For information on components not listed here, please contact BINDER Service.

23.7 Dimensions KBW 240

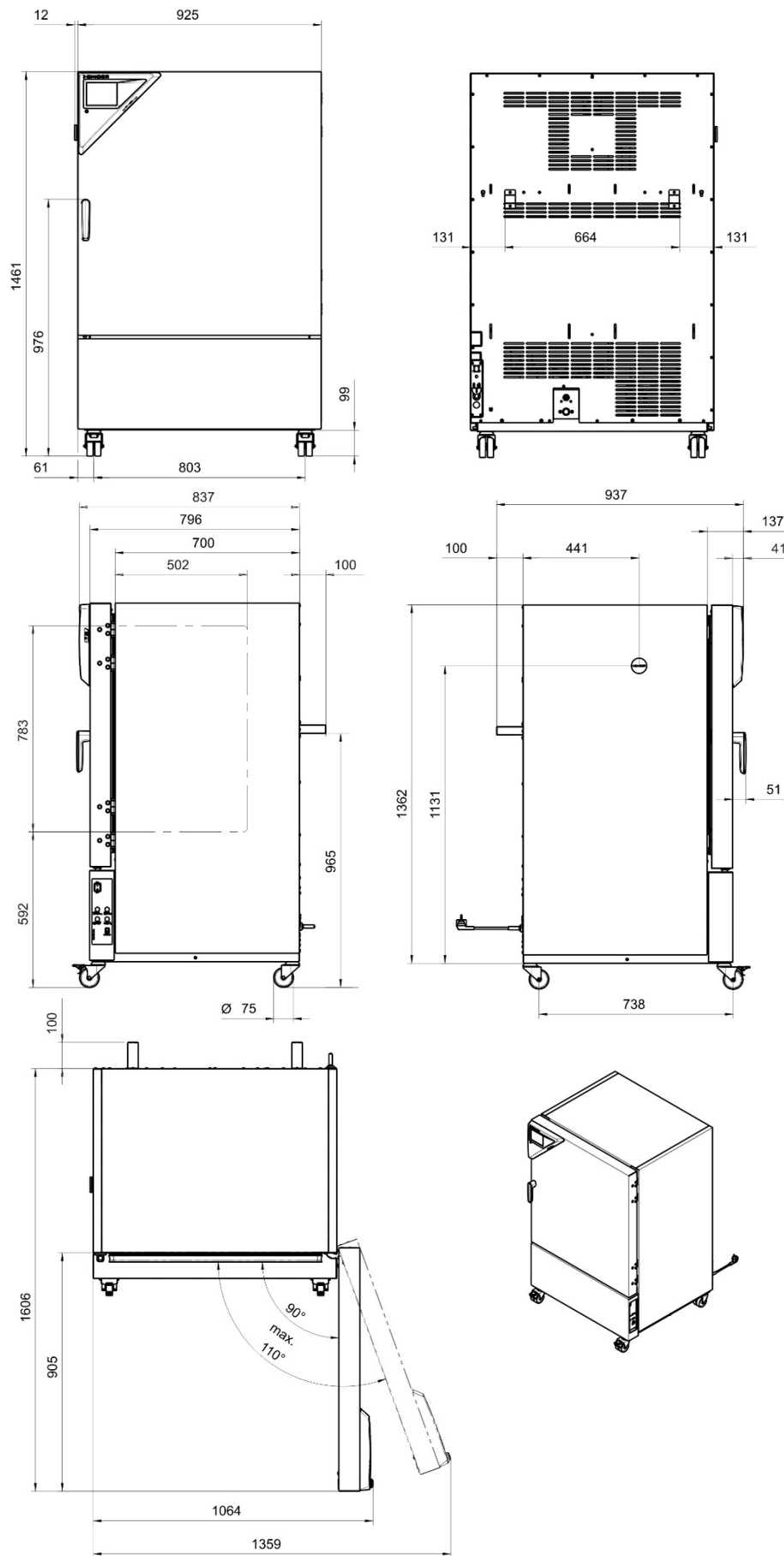

[mm]

23.8 Dimensions KBW 400

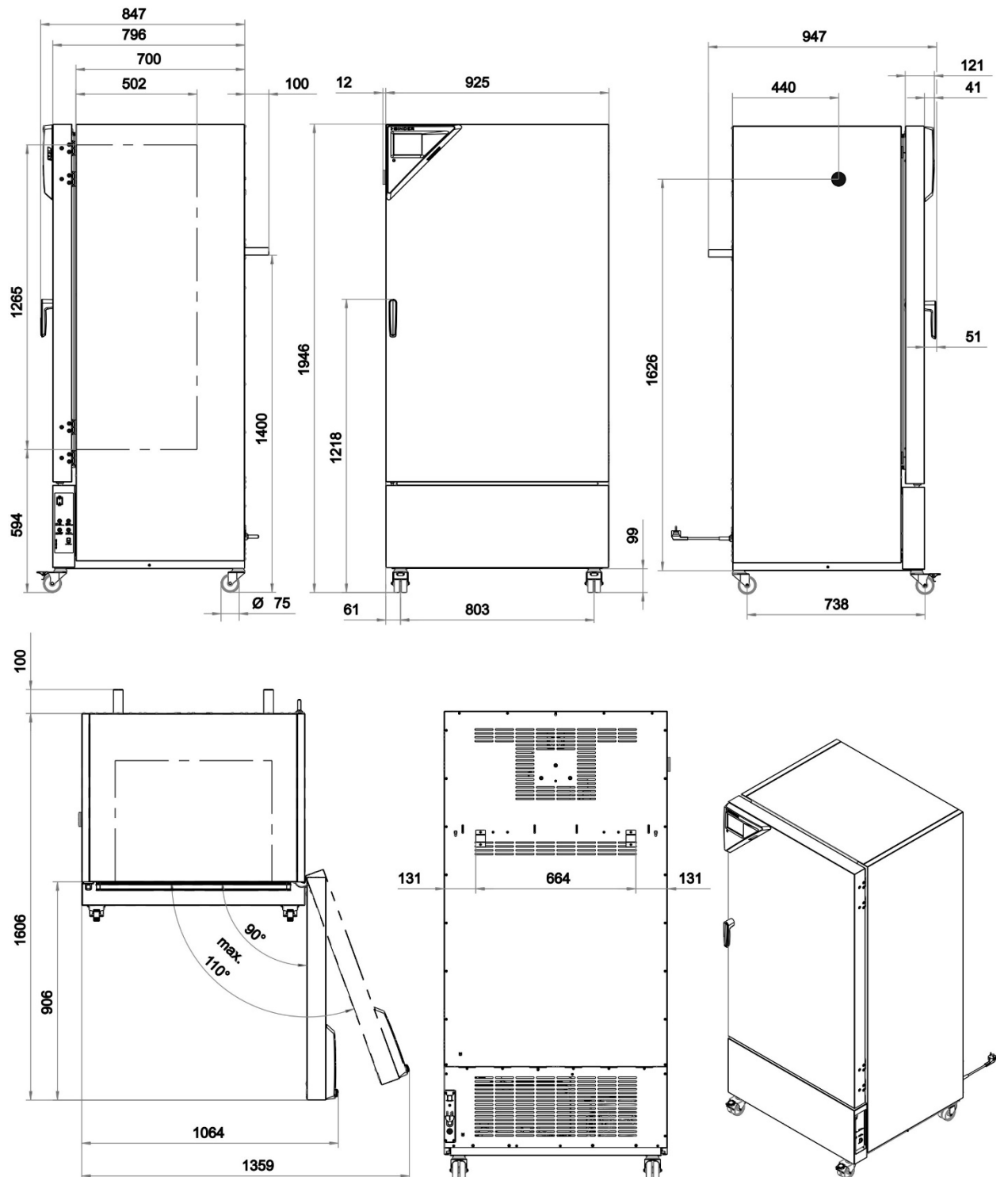

[mm]

23.9 Dimensions KBW 720

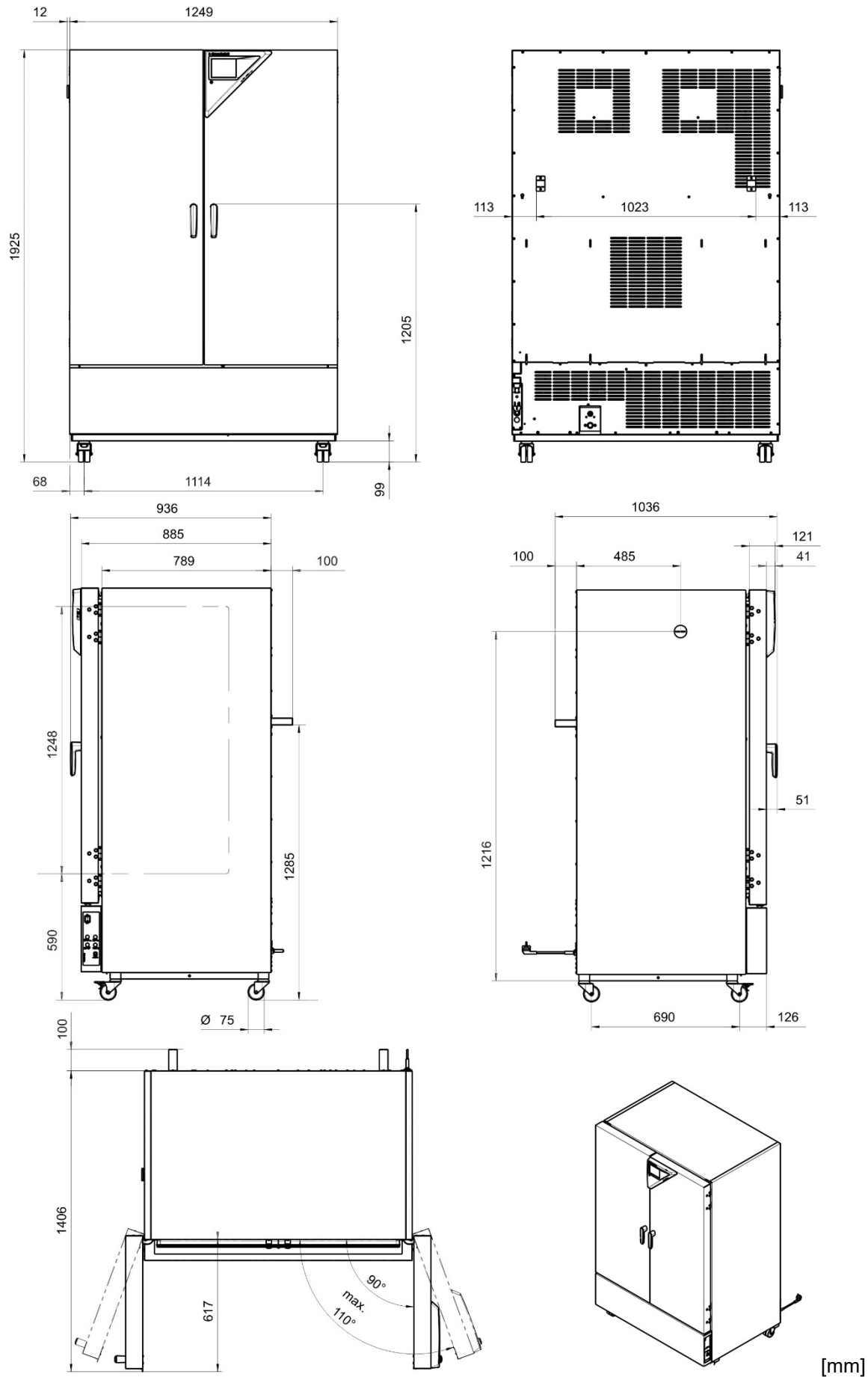

[mm]

24. Certificates and declarations of conformity

24.1 EU Declaration of Conformity

CE EU-Konformitätserklärung / EU Declaration of Conformity / Déclaration de conformité
 UE / Declaración de conformidad UE / Dichiarazione di conformità UE / Декларация
 соответствия EU

Hersteller / Manufacturer / Fabricant / Fabricante / Fabbricante / Производитель	BINDER GmbH
Anschrift / Address / Adresse / Dirección / Indirizzo / Адрес	Im Mittleren Ösch 5, 78532 Tuttlingen, Germany
Produkt / Product / Produit / Producto / Prodotto / Продукт	Wachstumsschränke mit Licht Growth chambers with light Armoires de croissance avec illumination Cámaras de crecimiento con iluminación Camere di crescita con luce Камеры роста с освещением
Typenbezeichnung / Type / Type / Tipo / Tipo / Тип	KBW 240, KBW 400, KBW 720 (E6)
Art. No. / Art. no. / Réf. / Art. N° / Art. n. / № арт.	9020-0338, 9120-0338, 9020-0339, 9120-0339 9020-0340, 9120-0340

Die oben beschriebenen Maschinen sind konform mit folgenden EG/EU-Richtlinien (gemäß Veröffentlichung im Amtsblatt der europäischen Kommission):

The machines described above are in conformity with the following EC/EU Directives (as published in the Official Journal of the European Union):

Les machines décrites ci-dessus sont conformes aux directives CE/UE suivantes (selon leur publication dans le Journal officiel de l'Union européenne):

La máquina descrita arriba cumple con las siguientes directivas de la CE/UE (publicados en el Diario oficial de la Unión Europea):

Le macchine sopra descritte sono conforme alle seguenti direttive CE/UE (secondo la pubblicazione nella Gazzetta ufficiale della Commissione europea):

Машина, указанная выше, полностью соответствует следующим регламентам ЕС/EU (опубликованным в Официальном журнале Европейского Содружества):

- **2006/42/EC**
 Maschinenrichtlinie 2006/42/EG / Machinery directive 2006/42/EC / Directive Machines 2006/42/EC / Directiva 2006/42/CE (Máquinas) / Direttiva macchine 2006/42/CE / Директива о машинах 2006/42/EC
- **2014/30/EU**
 EMV-Richtlinie 2014/30/EU / EMC Directive 2014/30/EU / Directive CEM 2014/30/UE / Directiva CEM 2014/30/UE / Direttiva EMC 2014/30/UE / Директива ЭМС 2014/30/EU
- **2011/65/EU, (EU) 2015/863**
 RoHS-Richtlinien 2011/65/EU und (EU) 2015/863 / RoHS Directives 2011/65/EU and (EU) 2015/863 / Directives RoHS 2011/65/UE et (UE) 2015/863 / Directivas RoHS 2011/65/UE y (UE) 2015/863 / Direttive RoHS 2011/65/UE et (UE) 2015/863 / Директивы RoHS 2011/65/EU и (EU) 2015/863

1 / 3

BINDER GmbH Postfach 102 D-78502 Tuttlingen **Anschrift:** BINDER GmbH Im Mittleren Ösch 5 D-78532 Tuttlingen
 Kontakt: Telefon: +49 (0) 74 62 / 20 05 – 0 | Telefax: +49 (0) 74 62 / 20 05 – 100 | info@binder-world.com | www.binder-world.com
 Geschäftsführung: Dipl.-Ing. Peter M. Binder | Amtsgericht Stuttgart, HRB 727150 | Sitz der Gesellschaft: Tuttlingen
 Bankverbindung: Kreissparkasse Tuttlingen | IBAN-Code: DE05 6435 0070 0000 0022 66 | SWIFT-Code: SOLA DE 51TUT
 \$-IBAN-Code: DE90 6435 0070 0220 2639 71 | SWIFT-Code: SOLA DE 51TUT
 Deutsche Bank Tuttlingen | IBAN-Code: DE56 6537 0075 0213 8709 00 | SWIFT-Code: DEUT DE 55653
 Altgeräte-Entsorgung gemäß WEEE-Reg.-Nr. DE 37004983

Die oben beschriebenen Maschinen entsprechen aufgrund ihrer Konzipierung und Bauart sowie in der von uns in Verkehr gebrachten Ausführung den einschlägigen grundlegenden Sicherheits- und Gesundheitsanforderungen der genannten EG/EU-Richtlinien.

The machines described above are conform to the mentioned EC/EU directives in regard to the relevant safety and health demands due to their conception and style of construction as well as to the version put onto market by us.

Les machines décrites ci-dessus correspondent aux demandes de sécurité et de santé des directives citées de la CE/UE due à leur conception et construction et dans la réalisation mise sur le marché par nous.

Las máquinas descritas arriba se corresponden con los requisitos básicos pertinentes de seguridad y salud de las citadas directivas de la CE/UE debido a su concepción y fabricación, así como a la realización llevada a cabo por nosotros.

Le macchine sopra descritte sono conforme ai requisiti essenziali di sanità e sicurezza pertinenti delle summenzionate direttive CE/UE in termini di progettazione, tipo di costruzione ed esecuzione messa da noi in circolazione.

Машины описано выше, соответствует указанным директивам ЕС/ЕУ в отношении требований соответствующей безопасности и здоровья по концепции и конструкции так же как и версия, применяемая нами на рынке.

Die oben beschriebenen Maschinen tragen entsprechend die Kennzeichnung CE.

The machines described above, corresponding to this, bear the CE-mark.

Les machines décrits ci-dessus, en correspondance, portent l'indication CE.

Las máquinas descritas arriba, en conformidad, llevan la indicación CE.

Le macchine sopra descritte sono contrassegnate dal marchio CE.

Машины описано выше, в соответствии с изложенным выше маркированы знаком CE.

Die oben beschriebenen Maschinen sind konform mit folgenden harmonisierten Normen:

The machines described above are in conformity with the following harmonized standards:

Les machines décrits ci-dessus sont conformes aux normes harmonisées suivantes:

Las máquinas descritas arriba cumplen con las siguientes normas:

Le macchine sopra descritte sono conforme alle seguenti normative armonizzate:

Машины описано выше, полностью соответствуют следующим стандартам:

EMV / EMC / CEM / CEM / EMC / ЭМС
• EN 61326-1:2013
RoHS
• EN IEC 63000:2018

Sicherheit / Safety / Sécurité / Seguridad / Sicurezza / Нормативы по безопасности

- Baumusterprüfbescheinigung NV 20123, ausgestellt von der DGUV Test am 29.01.2021 gemäß den DGUV Test Prüfgrundsätzen GS-NV 5:2019/08 in Übereinstimmung mit EN ISO 12100, EN ISO 13732-1, EN 60204-1
- Type Test Certificate NV 20123 issued by the DGUV Test on January 29, 2021 acc. to the DGUV Test Principles GS-NV 5:2019/08 in accordance with EN ISO 12100, EN ISO 13732-1, EN 60204-1
- Certificat d'examen de type NV 20123, émis par la DGUV Test le 29.01.2021 selon les principes de test DGUV Test GS-NV 5:2019/08 conformément aux normes EN ISO 12100, EN ISO 13732-1, EN 60204-1
- Certificado de examen de tipo NV 20123, emitido por DGUV Test el 29.01.2021 de acuerdo con los principios de prueba DGUV Test GS-NV 5:2019/08 de acuerdo con las normas EN ISO 12100, EN ISO 13732-1, EN 60204-1
- Certificato di esame del tipo NV 20123, rilasciato da DGUV Test il 29.01.2021 in conformità con i principi di prova DGUV Test GS-NV 5:2019/08 secondo secondo le norme EN ISO 12100, EN ISO 13732-1, EN 60204-1
- Сертификат типового испытания NV 20123, выданный «DGUV Test» 29.01.2021 в соответствии с принципами испытаний DGUV Test GS-NV 5:2019/08 в соответствии со стандартами EN ISO 12100, EN ISO 13732-1, EN 60204-1

78532 Tuttlingen, 14.09.2021

BINDER GmbH



P. Wimmer

Vice President

Vice President

Vice président

Vicepresidente

vicepresidente

Вице-президент



J. Bollaender

Leiter F & E

Director R & D

Chef de service R&D

Responsable I & D

Direttore R & D

Глава департамента R&D

3 / 3

BINDER GmbH Postfach 102 D-78502 Tuttlingen **Anschrift:** BINDER GmbH Im Mittleren Ösch 5 D-78532 Tuttlingen
Kontakt: Telefon: +49 (0) 74 62 / 20 05 – 0 | Telefax: +49 (0) 74 62 / 20 05 – 100 | info@binder-world.com | www.binder-world.com
Geschäftsführung: Dipl.-Ing. Peter M. Binder | Amtsgericht Stuttgart, HRB 727150 | Sitz der Gesellschaft: Tuttlingen
Bankverbindung: Kreissparkasse Tuttlingen | IBAN-Code: DE05 6435 0070 0000 0022 66 | SWIFT-Code: SOLA DE 3103
S-IBAN-Code: DE90 6435 0070 0220 2639 71 | SWIFT-Code: SOLA DE 3103
Deutsche Bank Tuttlingen | IBAN-Code: DE56 6537 0075 0213 8709 00 | SWIFT-Code: DEUT DE 3305
Altgeräte-Entsorgung gemäß WEEE-Reg.-Nr. DE 37004983

24.2 Certificate for the GS mark of conformity of the “Deutsche Gesetzliche Unfallversicherung e.V.“ (German Social Accident Insurance) DGUV

Zertifikat
Nr. **NV 20122**
vom 29.01.2021



GS-Zertifikat

Name und Anschrift des Zertifikatsinhabers: (Auftraggeber) **Binder GmbH**
Im Mittleren Ösch 5
78532 Tuttlingen

Produktbezeichnung: **Klimaschränke Klima- und Kühlbrutschränke**

Typ: KBF P 240, KBF P 720, KBF LQC 240, KBF LQC 720, KBWF 240, KBWF 720, KBF 115, KBF 240, KBF 720, KMF 115, KMF 240, KMF 720, KBW 240, KBW 400, KBW 720, KB 23, KB 53, KB 115, KB 240, KB 400, KB 720, KBF 1020, KBF 115 - DC, KBF 115 - DCL

Prüfgrundlage: GS-NV 5:2019/08 Prüfgrundsätze für Kühl- und Gefriermaschinen für Industrie und Gewerbe

Zugehöriger Prüfbericht: Prüfbericht zum Zertifikat NV 20122

Weitere Angaben: Das Zertifikat bezieht sich auf die im zugehörigen Prüfbericht beschriebene Ausführung des Produkts.
Nachfolgebesccheinigung zu denjenigen mit den Prüfnummern NV 15127 und NV 17216

Das geprüfte Baumuster stimmt mit den in § 21 Absatz 1 des Produktsicherheitsgesetzes genannten Anforderungen überein. Der Zertifikatsinhaber ist berechtigt, das umseitig abgebildete GS-Zeichen an den mit dem geprüften Baumuster übereinstimmenden Produkten anzubringen. Der Zertifikatsinhaber hat dabei die umseitig aufgeführten Bedingungen zu beachten.

Dieses Zertifikat einschließlich der Berechtigung zur Anbringung des GS-Zeichens ist gültig bis einschließlich:

21.06.2025

Weiteres über die Gültigkeit, eine Gültigkeitsverlängerung und andere Bedingungen regelt die Prüf- und Zertifizierungsordnung.



Rückseite GS-Zertifikat: NV 20122

GS-Zeichen



Normalausführung



Bei einer Höhe von 20 mm oder weniger
auch zulässige Ausführung

1. Der Zertifikatsinhaber hat die Voraussetzungen einzuhalten, die bei der Herstellung des umseitig genannten Produktes zu beachten sind, um die Übereinstimmung mit dem geprüften Baumuster zu gewährleisten.
2. Die Prüf- und Zertifizierungsstelle des Fachbereichs Nahrungsmittel führt in regelmäßigen Abständen Kontrollmaßnahmen zur Überwachung der Herstellung und rechtmäßigen Verwendung des GS-Zeichens durch.
3. Die für die Herstellung verantwortliche Person hat sich zur Einhaltung der Voraussetzungen nach Nummer 1 und Duldung der Kontrollmaßnahmen verpflichtet.
4. Die Prüf- und Zertifizierungsstelle entzieht dem Zertifikatsinhaber die Zuerkennung des GS-Zeichens, wenn sich die Anforderungen nach § 21 Absatz 1 Produktsicherheitsgesetz geändert haben oder die Voraussetzungen nach Nummer 1 nicht eingehalten werden.
5. Das GS-Zeichen darf nur verwendet und mit ihm darf nur geworben werden, wenn die Voraussetzungen nach § 22 Produktsicherheitsgesetz erfüllt sind.

25. Contamination clearance certificate

25.1 For chambers located outside USA and Canada

Declaration regarding safety and health

Erklärung zur Sicherheit und gesundheitlichen Unbedenklichkeit

The German Ordinance on Hazardous Substances (GefStofV), and the regulations regarding safety at the workplace, require that this form be filled out for all products that are returned to us, so that the safety and the health of our employees can be guaranteed

Die Sicherheit und Gesundheit unserer Mitarbeiter, die Gefahrstoffverordnung GefStofV und die Vorschriften zur Sicherheit am Arbeitsplatz machen es erforderlich, dass dieses Formblatt für alle Produkte, die an uns zurückgeschickt werden, ausgefüllt wird.



Note: A repair is not possible without a completely filled out form.
Ohne Vorliegen des vollständig ausgefüllten Formblattes ist eine Reparatur nicht möglich.

- A completely filled out form must be transmitted via Fax (+49 (0) 7462 2005 93555) or by letter in advance, so that this information is available before the equipment/component part arrives. A second copy of this form must accompany the equipment/component part. In addition, the carrier should be notified.

Eine vollständig ausgefüllte Kopie dieses Formblattes soll per Fax unter Nr. +49 (0) 7462 2005 93555 oder Brief vorab an uns gesandt werden, so dass die Information vorliegt, bevor das Gerät/Bauteil eintrifft. Eine weitere Kopie soll dem Gerät/Bauteil beigelegt sein. Ggf. ist die Spedition zu informieren.

- Incomplete information or non-conformity with this procedure will inevitably lead to substantial delays in processing. Please understand the reason for this measure, which lies outside our area of influence, and will help us to speed up this procedure.

Unvollständige Angaben oder Nichteinhalten dieses Ablaufs führen zwangsläufig zu beträchtlichen Verzögerungen in der Abwicklung. Bitte haben Sie Verständnis für Maßnahmen, die außerhalb unserer Einflussmöglichkeiten liegen und helfen Sie mit, den Ablauf zu beschleunigen.

- **Please print and fill out this form completely**

Bitte unbedingt vollständig ausfüllen!

1.	Unit/ component part / type / Gerät / Bauteil / Typ:
2.	Serial No. / Serien-Nr.:
3.	Details about utilized substances / biological substances / Einzelheiten über die eingesetzten Substanzen/biologische Materialien:
3.1	Designations / Bezeichnungen:
a)	_____
b)	_____
c)	_____
3.2	Safety measures required for handling these substances / Vorsichtsmaßnahmen beim Umgang mit diesen Stoffen:
a)	_____
b)	_____
c)	_____

3.3	Measures to be taken in case of skin contact or release into the atmosphere / Maßnahmen bei Personenkontakt oder Freisetzung: a) _____ b) _____ c) _____ d) _____
3.4	Other important information that must be taken into account / Weitere zu beachtende und wichtige Informationen: a) _____ b) _____ c) _____
4.	Declaration on the risk of these substances (please checkmark the applicable items) / Erklärung zur Gefährlichkeit der Stoffe (bitte Zutreffendes ankreuzen):
<input type="checkbox"/>	4.1 For non toxic, non radioactive, biologically harmless materials / für nicht giftige, nicht radioaktive, biologisch ungefährliche Stoffe: We hereby guarantee that the above-mentioned unit / component part... / Wir versichern, dass o.g. Gerät/Bauteil... <input type="checkbox"/> Has not been exposed to or contains any toxic or otherwise hazardous substances / weder giftige noch sonstige gefährliche Stoffe enthält oder solche anhaften. <input type="checkbox"/> That eventually generated reaction products are non-toxic and also do not represent a hazard / auch evtl. entstandene Reaktionsprodukte weder giftig sind noch sonst eine Gefährdung darstellen. <input type="checkbox"/> Eventual residues of hazardous substances have been removed / evtl. Rückstände von Gefahrstoffen entfernt wurden.
<input type="checkbox"/>	4.2 For toxic, radioactive, biologically harmful or hazardous substances, or any other hazardous materials / für giftige, radioaktive, biologisch bedenkliche bzw. gefährliche Stoffe oder anderweitig gefährliche Stoffe. We hereby guarantee that ... / Wir versichern, dass ... <input type="checkbox"/> The hazardous substances, which have come into contact with the above-mentioned equipment / component part, have been completely listed under item 3.1 and that all information in this regard is complete / die gefährlichen Stoffe, die mit dem o.g. Gerät/Bauteil in Kontakt kamen, in 3.1 aufgelistet sind und alle Angaben vollständig sind. <input type="checkbox"/> That the unit /component part has not been in contact with radioactivity / das Gerät/Bauteil nicht mit Radioaktivität in Berührung kam
5.	Kind of transport / transporter / Transportweg/Spediteur: Transport by (means and name of transport company, etc.) / Versendung durch (Name Spediteur o.ä.) _____ Date of dispatch to BINDER GmbH / Tag der Absendung an BINDER GmbH: _____

We hereby declare that the following measures have been taken / Wir erklären, dass folgende Maßnahmen getroffen wurden:

- Hazardous substances were removed from the unit including component parts, so that no hazard exists for any person in the handling or repair of these items / das Gerät/Bauteil wurde von Gefahrstoffen befreit, so dass bei Handhabung/Reparaturen für die betreffenden Person keinerlei Gefährdung besteht
- The unit was securely packaged and properly identified / das Gerät wurde sicher verpackt und vollständig gekennzeichnet.
- Information about the hazardousness of the shipment (if required) has been provided to the transporter / der Spediteur wurde (falls vorgeschrieben) über die Gefährlichkeit der Sendung informiert.

We hereby commit ourselves and guarantee that we will indemnify BINDER GmbH for all damages that are a consequence of incomplete or incorrect information provided by us, and that we will exempt BINDER GmbH from eventual damage claims by third parties./ Wir versichern, dass wir gegenüber BINDER für jeden Schaden, der durch unvollständige und unrichtige Angaben entsteht, haften und BINDER gegen eventuell entstehende Schadenansprüche Dritter freistellen.

We are aware that, in accordance with Article 823 of the German Civil Code (BGB), we are directly liable with regard to third parties, in this instance especially the employees of BINDER GmbH, who have been entrusted with the handling / repair of the unit / component. / Es ist uns bekannt, dass wir gegenüber Dritten – hier insbesondere mit der Handhabung/Reparatur des Geräts/des Bauteils betraute Mitarbeiter der Firma BINDER - gemäß §823 BGB direkt haften

Name: _____

Position/ Title: _____

Date / Datum: _____

Signature / Unterschrift: _____

Company stamp / Firmenstempel:



Equipment that is returned to the factory for repair must be accompanied by a completely filled out contamination clearance certificate. For service and maintenance on site, such a contamination clearance certificate must be submitted to the service technician before the start of any work. No repair or maintenance of the equipment is possible, without a properly filled out contamination clearance certificate.

25.2 For chambers located in USA and Canada

Product Return Authorization Request

Please complete this form and the Customer Decontamination Declaration (next 2 pages) and attach the required pictures. E-mail to: IDL_SalesOrderProcessing_USA@binder-world.com

After we have received and reviewed the complete information we will decide on the issue of a RMA number. Please be aware that size specifications, voltage specifications as well as performance specifications are available on the internet at www.binder-world.us at any time.

Take notice of shipping laws and regulations.

	Please fill:	
Reason for return request	<input type="radio"/> Duplicate order	
	<input type="radio"/> Duplicate shipment	
	<input type="radio"/> Demo	<i>Page one completed by sales</i>
	<input type="radio"/> Power Plug / Voltage	115V / 230 V / 208 V / 240V
	<input type="radio"/> Size does not fit space	
	<input type="radio"/> Transport Damage	Shock watch tripped? (<i>pictures</i>)
	<input type="radio"/> Other (specify below)	

Is there a replacement PO?	<input type="radio"/> Yes <input type="radio"/> No	
<i>If yes -> PO #</i>		
<i>If yes -> Date PO placed</i>		
Purchase order number		
BINDER model number		
BINDER serial number		
Date unit was received		
Was the unit unboxed?	<input type="radio"/> Yes <input type="radio"/> No	
Was the unit plugged in?	<input type="radio"/> Yes <input type="radio"/> No	
Was the unit in operation?	<input type="radio"/> Yes <input type="radio"/> No	
<i>Pictures of unit attached?</i>	<input type="radio"/> Yes <input type="radio"/> No	Pictures have to be attached!
<i>Pictures of Packaging attached?</i>	<input type="radio"/> Yes <input type="radio"/> No	

	Customer Contact Information	Distributor Contact Information
Name		
Company		
Address		
Phone		
E-mail		

Customer (End User) Decontamination Declaration

Health and Hazard Safety declaration

To protect the health of our employees and the safety at the workplace, we require that this form is completed by the user for all products and parts that are returned to us. (Distributors or Service Organizations cannot sign this form)



NO RMA number will be issued without a completed form. Products or parts returned to our NY warehouse without an RMA number will be refused at the dock.

A second copy of the completed form must be attached to the outside of the shipping box.

1.	Unit/ component part / type:
2.	Serial No.
3.	List any exposure to hazardous liquids, gasses or substances and radioactive material
3.1	List with MSDS sheets attached where available or needed (if there is not enough space available below, please attach a page):
a)	_____
b)	_____
c)	_____
3.2	Safety measures required for handling the list under 3.1
a)	_____
b)	_____
c)	_____
3.3	Measures to be taken in case of skin contact or release into the atmosphere:
a)	_____
b)	_____
c)	_____
d)	_____
3.4	Other important information that must be considered:
a)	_____
b)	_____
c)	_____

4. Declaration of Decontamination

For toxic, radioactive, biologically and chemically harmful or hazardous substances, or any other hazardous materials.

We hereby guarantee that

- 4.1 Any hazardous substances, which have come into contact with the above-mentioned equipment / component part, have been completely listed under item 3.1 and that all information in this regard is complete.
- 4.2 That the unit /component part has not been in contact with radioactivity
- 4.3 Any Hazardous substances were removed from the unit / component part, so that no hazard exists for a person in the shipping, handling or repair of these returned unit
- 4.4 The unit was securely packaged in the original undamaged packaging and properly identified on the outside of the packaging material with the unit designation, the RMA number and a copy of this declaration.
- 4.5 Shipping laws and regulations have not been violated.

I hereby commit and guarantee that we will indemnify BINDER Inc. for all damages that are a consequence of incomplete or incorrect information provided by us, and that we will indemnify and hold harmless BINDER Inc. from eventual damage claims by third parties.

Name: _____

Position: _____

Company: _____

Address: _____

Phone #: _____

Email: _____

Date: _____

Signature: _____



Equipment returned to the NY warehouse for repair must be accompanied by a completed customer decontamination declaration. For service and maintenance works on site, such a customer decontamination declaration must be submitted to the service technician before the start of work. No repair or maintenance of the equipment is possible without a completed form.