

# Operating Manual

Translation of the original operating manual

## KB ECO / KB ECO-UL (E6.2)

Cooling incubators with RD4 controller and Peltier technology

Model	Model version	Art. No.
KB ECO 240	KBECO240-230V	9020-0423, 9120-0423
KB ECO 240-UL	KBECO240UL-120V	9020-0426, 9120-0426
KB ECO 720	KBECO720-230V	9020-0424, 9120-0424
KB ECO 720-UL	KBECO720UL-120V	9020-0427, 9120-0427
KB ECO 1020	KBECO1020-230V	9020-0425, 9120-0425
KB ECO 1020-UL	KBECO1020UL-120V	9020-0428, 9120-0428

### **BINDER GmbH**

- ▶ Address: Post office box 102, 78502 Tuttlingen, Germany ▶ Phone: +49 7462 2005 0
- ▶ Fax: +49 7462 2005 100 ▶ Internet: <http://www.binder-world.com>
- ▶ E-mail: [info@binder-world.com](mailto:info@binder-world.com) ▶ Service Hotline: +49 7462 2005 555
- ▶ Service Fax: +49 7462 2005 93 555 ▶ Service E-Mail: [customerservice@binder-world.com](mailto:customerservice@binder-world.com)
- ▶ Service Hotline USA: +1 866 885 9794 or +1 631 224 4340 x3
- ▶ Service Hotline Asia Pacific: +852 390 705 04 or +852 390 705 03
- ▶ Service Hotline Russia and CIS: +7 495 988 15 16

---

## Content

<b>1. SAFETY</b>	<b>5</b>
1.1 Personnel Qualification	5
1.2 Operating manual	5
1.3 Legal considerations	5
1.3.1 Intellectual property	6
1.4 Structure of the safety instructions	6
1.4.1 Signal word panel	6
1.4.2 Safety alert symbol	7
1.4.3 Pictograms	7
1.4.4 Word message panel structure	8
1.5 Localization / position of safety labels on the chamber	8
1.6 Type plate	9
1.7 General safety instructions on installing and operating the chambers	10
1.8 Intended use	12
1.9 Foreseeable Misuse	13
1.10 Residual Risks	14
1.11 Operating instructions	15
1.12 Measures to prevent accidents	15
<b>2. CHAMBER DESCRIPTION</b>	<b>17</b>
2.1 Chamber overview	18
<b>3. COMPLETENESS OF DELIVERY, TRANSPORTATION, STORAGE, AND INSTALLATION</b>	<b>19</b>
3.1 Unpacking, and checking equipment and completeness of delivery	19
3.2 Guidelines for safe lifting and transportation	19
3.3 Storage	20
3.4 Location of installation and ambient conditions	20
<b>4. INSTALLATION AND CONNECTIONS</b>	<b>22</b>
4.1 Condensate collection pan	22
4.2 Electrical connection	23
<b>5. FUNCTIONAL OVERVIEW OF THE RD4 CHAMBER CONTROLLER</b>	<b>24</b>
5.1 Menu structure of the controller and access levels	25
5.2 Performance during and after power failures	26
<b>6. START UP</b>	<b>26</b>
<b>7. TEMPERATURE SET-POINT ENTRY</b>	<b>27</b>
7.1 Temperature set-point entry	27
<b>8. AUTOMATIC SETPOINT SWITCHOVER</b>	<b>27</b>
8.1 Control by date	28
8.2 Regular cyclic control	30
8.3 Entry of the alternative temperature set-point	31
8.4 Activating / deactivating "Idle mode" function	32
<b>9. SPECIAL CONTROLLER FUNCTIONS – IDLE MODE</b>	<b>33</b>
<b>10. PASSWORD</b>	<b>34</b>
10.1 Password request	34
10.2 Assign and modify a password	35
10.2.1 Assign and modify the User password	35
10.2.2 Assign and modify the Admin password	35

<b>11. TEMPERATURE SAFETY DEVICES</b> .....	<b>36</b>
11.1 Over temperature protective device (class 1) .....	36
11.2 Overtemperature safety controller class 3.1 .....	36
11.2.1 Setting the safety controller mode .....	37
11.2.2 Setting the safety controller value.....	37
11.2.3 Message and measures in the state of alarm.....	38
11.2.4 Function check.....	38
<b>12. GENERAL CONTROLLER SETTINGS</b> .....	<b>39</b>
12.1 Selecting the controller's menu language .....	39
12.2 Selecting the temperature unit .....	39
12.3 Setting the current date.....	40
12.4 Setting the current time .....	40
12.5 Function "Language selection at restart" .....	41
12.6 Setting the chamber address .....	41
12.7 Display brightness .....	42
<b>13. TOLERANCE RANGE SETTINGS</b> .....	<b>42</b>
13.1 Setting the delay time for tolerance range alarm .....	42
13.2 Setting the temperature tolerance range .....	43
<b>14. ALARM FUNCTIONS</b> .....	<b>43</b>
14.1 Alarm messages .....	43
14.2 Activating / deactivating the audible alarm (alarm buzzer).....	44
<b>15. PROGRAM START / STOP FUNCTION</b> .....	<b>44</b>
15.1 Start time program .....	44
15.2 Start week program .....	45
15.3 Stop program .....	45
<b>16. ETHERNET NETWORK SETTINGS</b> .....	<b>45</b>
16.1 Showing the network settings .....	45
16.1.1 Showing the chamber's MAC address.....	46
16.1.2 Showing the IP address.....	46
16.1.3 Showing the subnet mask.....	46
16.1.4 Showing the standard gateway.....	47
16.1.5 Showing the DNS server address.....	47
16.1.6 Showing the DNS chamber name .....	47
16.2 Changing the configuration of the network settings.....	48
16.2.1 Selecting the type of IP address assignment (automatic / manual) .....	48
16.2.2 Selecting the type of assignment of the DNS server address (automatic / manual) .....	48
16.2.3 Assigning the IP address .....	49
16.2.4 Setting the subnet mask .....	50
16.2.5 Setting the standard gateway .....	50
16.2.6 Assigning the DNS server address.....	50
<b>17. DATA RECORDER</b> .....	<b>51</b>
17.1 Recorded data.....	51
17.2 Storage capacity .....	52
17.3 Setting the storage rate for the "DL1" recorder data.....	52
17.4 Deleting the data recorder.....	52
<b>18. USB MENU: DATA TRANSFER VIA USB INTERFACE</b> .....	<b>53</b>
18.1 Connecting the USB stick .....	53
18.2 Import function .....	53
18.3 Export functions .....	54
18.4 Ongoing data transfer .....	54
18.5 Error during data transmission.....	54
18.6 Removing the USB stick .....	55

<b>19. SELF-TEST FUNCTION</b> .....	<b>55</b>
19.1 Activating the self-test function .....	55
19.2 Deactivating the self-test mode .....	56
<b>20. DEFROSTING AT REFRIGERATING OPERATION</b> .....	<b>57</b>
<b>21. ANTI-CONDENSATION PROTECTION</b> .....	<b>57</b>
<b>22. OPTIONS</b> .....	<b>58</b>
22.1 APT-COM™ 4 Multi Management Software (option) .....	58
22.2 Data logger kit (option) .....	58
<b>23. CLEANING AND DECONTAMINATION</b> .....	<b>58</b>
23.1 Cleaning .....	59
23.2 Decontamination / chemical disinfection .....	60
<b>24. MAINTENANCE AND SERVICE, TROUBLESHOOTING, REPAIR, TESTING...</b>	<b>61</b>
24.1 General information, personnel qualification .....	61
24.2 Maintenance intervals, service .....	62
24.3 Service Reminder .....	62
24.4 Simple troubleshooting .....	63
24.5 Sending the chamber back to BINDER GmbH .....	64
<b>25. DISPOSAL</b> .....	<b>65</b>
25.1 Disposal of the transport packing .....	65
25.2 Decommissioning .....	65
25.3 Disposal of the chamber in the Federal Republic of Germany .....	65
25.4 Disposal of the chamber in the member states of the EU except for the Federal Republic of Germany .....	66
25.5 Disposal of the chamber in non-member states of the EU .....	67
<b>26. TECHNICAL DESCRIPTION</b> .....	<b>68</b>
26.1 Factory calibration and adjustment .....	68
26.2 Over current protection .....	68
26.3 Definition of usable volume .....	68
26.4 KB ECO / KB ECO-UL technical data .....	69
26.5 Equipment and options (extract) .....	70
26.6 Accessories and spare parts (extract) .....	71
26.7 Dimensions .....	72
<b>27. CERTIFICATES AND DECLARATIONS OF CONFORMITY</b> .....	<b>75</b>
27.1 EU Declaration of Conformity .....	75
27.2 Certificate for the GS mark of conformity of the “Deutsche Gesetzliche Unfallversicherung e.V.” (German Social Accident Insurance) DGUV .....	78
<b>28. CONTAMINATION CLEARANCE CERTIFICATE</b> .....	<b>80</b>
28.1 For chambers located outside USA and Canada .....	80
28.2 For chambers located in USA and Canada .....	83

Dear customer,

For the correct operation of the chambers, it is important that you read this operating manual completely and carefully and observe all instructions as indicated. Failure to read, understand and follow the instructions may result in personal injury. It can also lead to damage to the chamber and/or poor equipment performance.

## 1. Safety

### 1.1 Personnel Qualification



The chamber must only be installed, tested, and started up by personnel qualified for assembly, startup, and operation of the chamber. Qualified personnel are persons whose professional education, knowledge, experience and knowledge of relevant standards allow them to assess, carry out, and identify any potential hazards in the work assigned to them. They must have been trained and instructed, and be authorized, to work on the chamber.

The chamber should only be operated by laboratory personnel especially trained for this purpose and familiar with all precautionary measures required for working in a laboratory. Observe the national regulations on minimum age of laboratory personnel.

### 1.2 Operating manual

This operating manual is part of the components of delivery. Always keep it handy for reference in the vicinity of the chamber. If selling the unit, hand over the operating manual to the purchaser.

To avoid injuries and damage observe the safety instructions of the operating manual. Failure to follow instructions and safety precautions can lead to significant risks.

	<div style="background-color: red; color: white; text-align: center; padding: 5px;">  <b>DANGER</b> </div> <p><b>Dangers due to failure to observe the instructions and safety precautions. Serious injuries and chamber damage. Risk of death.</b></p> <ul style="list-style-type: none"> <li>➤ Observe the safety instructions in this Operating Manual.</li> <li>➤ Follow the operating procedures in this Operating Manual.</li> <li>➤ Carefully read the complete operating instructions of the chamber prior to installing and using the chamber.</li> <li>➤ Keep the operating manual for future reference</li> </ul>
---	---

	<p>Make sure that all persons who use the chamber and its associated work equipment have read and understood the Operating Manual.</p>
---	--

This Operating Manual is supplemented and updated as needed. Always use the most recent version of the Operating Manual. When in doubt, call the BINDER Service Hotline for information on the up-to-date-ness and validity of this Operating Manual.

### 1.3 Legal considerations

This operating manual is for informational purposes only. It contains information for correct and safe installing, start-up, operation, decommissioning, cleaning and maintenance of the product. Note: the contents and the product described are subject to change without notice.

Understanding and observing the instructions in this operating manual are prerequisites for hazard-free use and safety during operation and maintenance. Images are to provide basic understanding. They may deviate from the actual version of the chamber. The actual scope of delivery can, due to optional or special design, or due to recent technical changes, deviate from the information and illustrations in these instructions this operating manual. In no event shall BINDER be held liable for any damages, direct or incidental arising out of or related to the use of this manual.

This operating manual cannot cover all conceivable applications. If you would like additional information, or if special problems arise that are not sufficiently addressed in this manual, please ask your dealer or contact us directly, e.g. by phone at the number located on page one of this manual

Furthermore, we emphasize that the contents of this operating manual are not part of an earlier or existing agreement, description, or legal relationship, nor do they modify such a relationship. All obligations on the part of BINDER derive from the respective purchase contract, which also contains the entire and exclusively valid statement of warranty administration and the general terms and conditions, as well as the legal regulations valid at the time the contract is concluded. The statements in this manual neither augment nor restrict the contractual warranty provisions.

### 1.3.1 Intellectual property

**Trademark Information:** All BINDER trademarks relating to products or service, as well as trade names, logos and product names used on the website, products and documents of BINDER company are trademarks or registered trademarks of BINDER company (including BINDER GmbH, BINDER Inc.) in the U.S. and other countries and communities of states. This includes word marks, position marks, word/figurative marks, design configurations, figurative marks, and design patents.

**Patent Information:** BINDER products, categories of products, and accessories may be covered by one or more patents and/or utility models in the U.S. and other countries and communities of states. Additional patent applications may also be pending in the U.S. and other countries and communities of states.

Please visit [www.binder-world.com](http://www.binder-world.com) for more information.

## 1.4 Structure of the safety instructions

In this operating manual, the following safety definitions and symbols indicate dangerous situations following the harmonization of ISO 3864-2 and ANSI Z535.6.

### 1.4.1 Signal word panel

Depending on the probability of serious consequences, potential dangers are identified with a signal word, the corresponding safety color, and if appropriate, the safety alert symbol.

 <b>DANGER</b>
Indicates an imminently hazardous situation that, if not avoided, will result in death or serious (irreversible) injury.

 <b>WARNING</b>
Indicates a potentially hazardous situation which, if not avoided, could result in death or serious (irreversible) injury.

 <b>CAUTION</b>
Indicates a potentially hazardous situation which, if not avoided, may result in moderate or minor (reversible) injury.

<b>NOTICE</b>
Indicates a potentially hazardous situation which, if not avoided, may result in damage to the product and/or its functions or of a property in its proximity.

### 1.4.2 Safety alert symbol



Use of the safety alert symbol indicates a **risk of injury**.

Observe all measures that are marked with the safety alert symbol in order to avoid death or injury.

### 1.4.3 Pictograms

Warning signs			
 Electrical hazard	 Hot surface	 Explosive atmosphere	 Stability hazard
 Lifting hazard	 Risk of corrosion and / or chemical burns	 Harmful substances	 Biohazard
 Pollution Hazard			
Mandatory action signs			
 Mandatory regulation	 Read operating instructions	 Disconnect the power plug	 Lift with several persons
 Lift with mechanical assistance	 Environment protection	 Wear protective gloves	 Wear safety goggles
Prohibition signs			
 Do NOT touch	 Do NOT spray with water	 Do NOT climb	
<b>Information</b> to be observed in order to ensure optimum function of the product.			

#### 1.4.4 Word message panel structure

**Type / cause of hazard.**



**Possible consequences.**

- ∅ Instruction how to avoid the hazard: prohibition
- Instruction how to avoid the hazard: mandatory action.

Observe all other notes and information not necessarily emphasized in the same way, in order to avoid disruptions that could result in direct or indirect injury or property damage.

#### 1.5 Localization / position of safety labels on the chamber

The following labels are located on the chamber:

Pictograms (warning signs)	
	Risk of injury (on chamber door, only KB ECO-UL). Observe the safety instructions in the operating manual.
Service label	
	

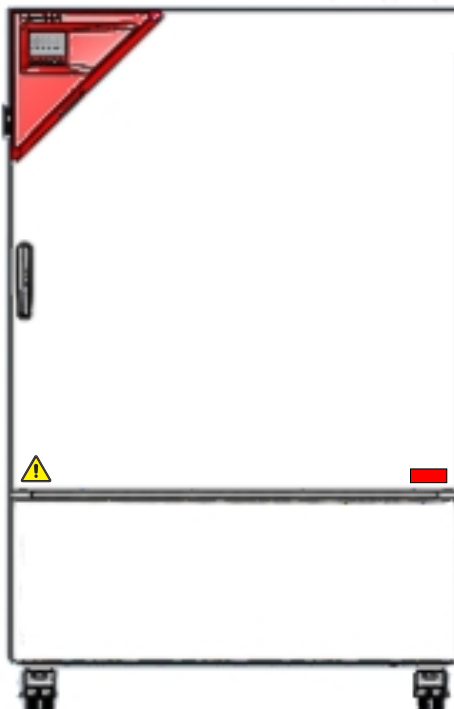

Figure 1: Position of labels on the chamber front (KB ECO-UL)



Keep safety labels complete and legible.

Replace safety labels that are no longer legible. Contact BINDER Service for these replacements.



## 1.6 Type plate

The type plate sticks to the left side of the chamber, bottom right-hand.

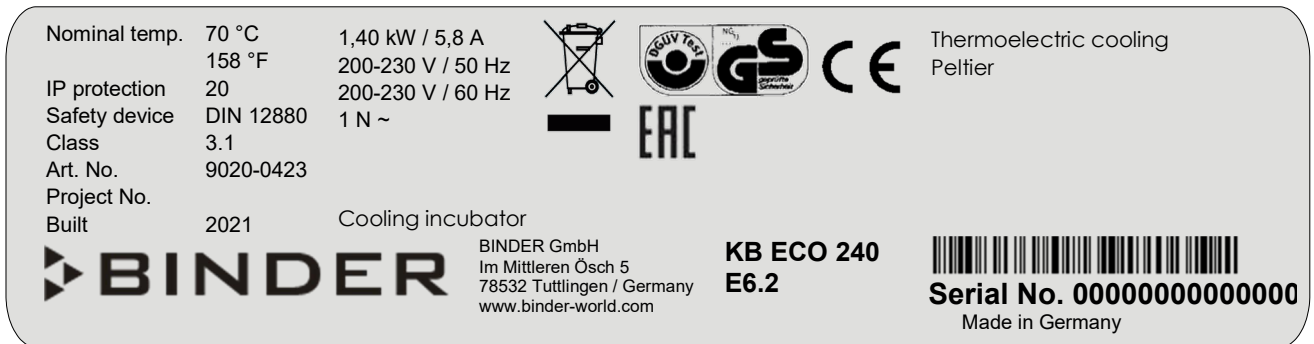

Figure 2: Type plate (example KB ECO 240 regular chamber 9020-0416)

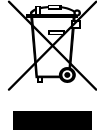





Figure 3: Type plate (example KB ECO 240-UL regular chamber 9020-0420)

### Indications of the type plate (example)

Indication		Information
BINDER		Manufacturer: BINDER GmbH
KB ECO 240		Model designation
Cooling incubator		Device name
Serial No.	000000000000000	Serial no. of the chamber
Built	2021	Year of construction
Nominal temperature	70 °C / 158 °F	Nominal temperature
IP protection	20	IP type of protection acc. to standard EN 60529
Temp. safety device	DIN 12880	Temperature safety device acc. to standard DIN 12880:2007
Class	3.1	Class of temperature safety device
Art. No.	9020-0426	Art. no. of the chamber
Project No.	---	Optional: Special application acc. to project no.
1,40 kW		Nominal power
5,8 A		Nominal current
200-230 V / 50 Hz		Nominal voltage range +/-10% at the indicated power frequency
208-230 V / 60 Hz		
1 N ~		Current type
Thermoelectric cooling Peltier		Peltier refrigerating technology

### Symbols on the type plate

Symbol	Valid for	Information
	All chambers	CE conformity marking
	All chambers	Electrical and electronic equipment manufactured / placed on the market in the EU after 13 August 2005 and be disposed of in separate collection according to Directive 2012/19/EU on waste electrical and electronic equipment (WEEE).
	Not for UL chambers	GS mark of conformity of the "Deutsche Gesetzliche Unfallversicherung e.V. (DGUV), Prüf- und Zertifizierungsstelle Nahrungsmittel und Verpackung im DGUV Test" (German Social Accident Insurance (DGUV), Testing and Certification Body for Foodstuffs and Packaging Industry in DGUV Test).
	Not for UL chambers	The chamber is certified according to Customs Union Technical Regulation (CU TR) for the Eurasian Economic Union (Russia, Belarus, Armenia, Kazakhstan Kyrgyzstan). (DRAFT)
	UL chambers only	The chamber is certified by Underwriters Laboratories Inc.® according to the following standards: <ul style="list-style-type: none"> <li>• UL 61010-1, 3<sup>rd</sup> Edition, 2012-05, Rev. 2015-07</li> <li>• CAN/CSA-C22.2 No. 61010-1, 3<sup>rd</sup> Edition, 2012-05, Rev. 2015-07</li> </ul>

## 1.7 General safety instructions on installing and operating the chambers



With regard to operating the chambers and to the installation location, please observe the local and national regulations relevant for your country (for Germany: DGUV guidelines 213-850 on safe working in laboratories, issued by the employers' liability insurance association).

BINDER GmbH is only responsible for the safety features of the chamber provided skilled electricians or qualified personnel authorized by BINDER perform all maintenance and repair, and if components relating to chamber safety are replaced in the event of failure with original spare parts.



To operate the chamber, use only original BINDER accessories or accessories from third-party suppliers authorized by BINDER. The user is responsible for any risk caused by using unauthorized accessories.

<b>NOTICE</b>	
	<p><b>Danger of overheating due to lack of ventilation.</b>  <b>Damage to the chamber.</b></p> <ul style="list-style-type: none"> <li>⊘ Do NOT install the chamber in unventilated recesses.</li> <li>➤ Ensure sufficient ventilation for dispersal of the heat.</li> <li>➤ Observe the prescribed minimum distances when installing the chamber (chap. 3.4)</li> </ul>

Do not install or operate the chamber in hazardous locations.



	 <b>DANGER</b>
	<p><b>Danger of explosion due to combustible dusts or explosive mixtures in the vicinity of the chamber.</b></p> <p><b>Serious injury or death from burns and / or explosion pressure.</b></p> <ul style="list-style-type: none"> <li>⊘ Do NOT operate the chamber in potentially explosive areas.</li> <li>➤ KEEP combustible dust or air-solvent mixtures AWAY from the chamber.</li> </ul>

The chamber does not dispose of any measures of explosion protection.

	 <b>DANGER</b>
	<p><b>Danger of explosion due to introduction of flammable or explosive substances in the chamber.</b></p> <p><b>Serious injury or death from burns and / or explosion pressure.</b></p> <ul style="list-style-type: none"> <li>⊘ Do NOT introduce any substance into the chamber which is combustible or explosive at working temperature.</li> <li>⊘ Do NOT introduce any combustible dust or air-solvent mixture in the inner chamber.</li> </ul>



Any solvent contained in the charging material must not be explosive or inflammable. I.e., irrespective of the solvent concentration in the steam room, NO explosive mixture with air must form. The temperature inside the chamber must lie below the flash point or below the sublimation point of the charging material. Familiarize yourself with the physical and chemical properties of the charging material, as well as the contained moisture constituent and its behavior with the addition of heat energy.



Familiarize yourself with any potential health risks caused by the charging material, the contained moisture constituent or by reaction products that may arise during the temperature process. Take adequate measures to exclude such risks prior to putting the chamber into operation.

	 <b>DANGER</b>
	<p><b>Electrical hazard by water entering the chamber.</b></p> <p><b>Deadly electric shock.</b></p> <ul style="list-style-type: none"> <li>⊘ The chamber must NOT become wet during operation, cleaning, or maintenance.</li> <li>⊘ Do NOT install the chamber in damp areas or in puddles.</li> <li>➤ Set up the chamber in a way that it is splash-proof.</li> </ul>

The chambers were produced in accordance with VDE regulations and were routinely tested in accordance to VDE 0411-1 (IEC 61010-1).

During and shortly after operation, the temperature of the inner surfaces almost equals the set-point. The inner chamber will become hot during operation.

	 <b>CAUTION</b>
	<p><b>Danger of burning by touching hot chamber parts during operation.</b></p> <p><b>Burns.</b></p> <ul style="list-style-type: none"> <li>⊘ Do NOT touch the inner surfaces or the loading material during operation.</li> </ul>

	 <b>WARNING</b>
	<p><b>Danger of injury and damages by the chamber tipping over or breakaway of the protruding lower housing cover.</b></p> <p><b>Injuries and damage to the chamber and the loading material</b></p> <ul style="list-style-type: none"> <li>∅ Do NOT load the lower housing cover with heavy objects while the chamber door is open and do NOT climb on it.</li> </ul>

## 1.8 Intended use

	<p>Following the instructions in this operating manual and conducting regular maintenance work (chap. 23) are part of the intended use.</p>
---	---

**Any use of the chambers that does not comply with the requirements specified in this Operating Manual shall be considered improper use.**

**Other applications than those described in this chapter are not approved.**

### Use



Cooling incubators KB ECO / KB ECO-UL are suitable for exact conditioning of harmless materials. Because of their precise temperature accuracy these devices are especially useful for cultivation of microorganisms with a narrow temperature optimum in a range of 4 °C / 39.2 °F to 37 °C / 98.6 °F. Main fields of application are tests of long-term storage (e.g. at 4 °C / 39.2 °F), refrigerated incubation between 20 °C / 68 °F and 25 °C / 77 °F and incubation at 37 °C / 98.6 °F (also with additional introduction of heat) or with alternating temperatures (e.g. 37 °C / 98.6 °F and 4 °C / 39.2 °F).

### Requirements for the chamber load



Any solvent must not be explosive and flammable. A mixture of any component of the charging material with air must NOT be explosive. The operating temperature must lie below the flash point or below the sublimation point of the charging material. Any component of the charging material must NOT be able to release toxic gases.

The loading material shall not contain any corrosive ingredients that may damage the machine components made of stainless steel, aluminum, and copper. Such ingredients include in particular acids and halides. Any corrosive damage caused by such ingredients is excluded from liability by BINDER GmbH.

The chamber does not dispose of any measures of explosion protection.

	 <b>DANGER</b>
	<p><b>Explosion or implosion hazard and danger of poisoning through the introduction of unsuitable loading material.</b></p> <p><b>Poisoning. Serious injury or death from burns and / or explosion pressure.</b></p> <ul style="list-style-type: none"> <li>∅ Do NOT introduce any substance combustible or explosive at working temperature into the chamber, in particular no energy sources such as batteries or lithium-ion batteries.</li> <li>∅ NO explosive dust or air-solvent mixture in the inner chamber.</li> <li>∅ Do NOT introduce any substance which could lead to release of toxic gases.</li> </ul>

Contamination of the chamber by toxic, infectious or radioactive substances must be prevented.

 	 <b>WARNING</b>
	<p><b>Danger of intoxication and infection through contamination of the chamber with toxic, infectious or radioactive substances.</b></p> <p><b>Damages to health.</b></p> <ul style="list-style-type: none"> <li>➤ Protect the interior of the chamber from contamination by toxic, infectious or radioactive substances.</li> <li>➤ Take suitable protective measures when introducing and removing toxic, infectious or radioactive material</li> </ul>

In case of foreseeable use of the chamber there is no risk for the user through the integration of the chamber into systems or by special environmental or operating conditions in the sense of EN 61010-1:2010. For this, the intended use of the chamber and all its connections must be observed.

### Medical devices

The chambers are not classified as medical devices as defined by the Medical Device Directive 93/42/EEC and Regulation (EU) No 2017/745.

	<p>Due to the special demands of the Medical Device Directive (MDD), these chambers are not qualified to perform sterilization of medical devices as defined by the directive 93/42/EEG.</p>
---	--

### Personnel Requirements

Only trained personnel with knowledge of the Operating Manual can set up and install the chamber, start it up, operate, clean, and take it out of operation. Service and repairs call for further technical requirements (e.g. electrical know-how), as well as knowledge of the service manual.

### Installation site requirements

The chambers are designed for setting up inside a building (indoor use).

The requirements described in the Operating Manual for installation site and ambient conditions (Chap. 3.4) must be met.

	<p><b>WARNING:</b> If customer should use a BINDER chamber running in non-supervised continuous operation, we strongly recommend in case of inclusion of irrecoverable specimen or samples to split such specimen or samples and store them in at least two chambers, if this is feasible.</p>
---	--

## 1.9 Foreseeable Misuse

Other applications than those described in chap. 1.8 are not approved.

This expressly includes the following misuses (the list is not exhaustive), which pose risks despite the inherently safe construction and existing technical safety equipment:

- Non-observance of Operating Manual
- Non-observance of information and warnings on the chamber (e.g. control unit messages, safety identifiers, warning signals)
- Installation, startup, operation, maintenance and repair by untrained, insufficiently qualified, or unauthorized personnel
- Missed or delayed maintenance and testing
- Non-observance of traces of wear and tear
- Insertion of materials excluded or not permitted by this Operating Manual.
- Non-compliance with the admissible parameters for processing the respective material.
- Installation, testing, service or repair in the presence of solvents

- Installation of replacement parts and use of accessories and operating resources not specified and authorized by the manufacturer
- Installation, startup, operation, maintenance or repair of the chamber in absence of operating instructions
- Bypassing or changing protective systems, operation of the chamber without the designated protective systems
- Non-observance of messages regarding cleaning and disinfection of the chamber.
- Spilling water or cleaning agent on the chamber, water penetrating into the chamber during operation, cleaning or maintenance.
- Cleaning activity while the chamber is turned on.
- Operation of the chamber with a damaged housing or damaged power cord
- Continued operation of the chamber during an obvious malfunction
- Insertion of objects, particularly metallic objects, in louvers or other openings or slots on the chamber
- Human error (e.g. insufficient experience, qualification, stress, exhaustion, laziness)

To prevent these and other risks from incorrect operation, the operator shall issue operating instructions. Standard operating procedures (SOPs) are recommended.

## 1.10 Residual Risks

The unavoidable design features of a chamber, as well as its proper field of application, can also pose risks, even during correct operation. These residual risks include hazards which, despite the inherently safe design, existing technical protective equipment, safety precautions and supplementary protective measures, cannot be ruled out.

Messages on the chamber and in the Operating Manual warn of residual risks. The consequences of these residual risks and the measures required to prevent them are listed in the Operating Manual. Moreover, the operator must take measures to minimize hazards from unavoidable residual risks. This includes, in particular, issuing operating instructions.

The following list summarizes the hazards against which this Operating Manual and the Service Manual warn, and specifies protective measures at the appropriate spots:

### Unpacking, Transport, Installation

- Sliding or tilting the chamber
- Setup of the chamber in unauthorized areas
- Installation of a damaged chamber
- Installation of a chamber with damaged power cord
- Inappropriate site of installation
- Missing protective conductor connection

### Normal operation

- Assembly errors
- Contact with hot surfaces on the housing
- Contact with hot surfaces in the interior and inside of doors
- Emission of non-ionizing radiation from electrical operating resources
- Contact with live parts in normal state

### **Cleaning and Decontamination**

- Penetration of water into the chamber
- Inappropriate cleaning and decontamination agents
- Enclosure of persons in the interior

### **Malfunction and Damage**

- Continued operation of the chamber during an obvious malfunction or outage of the heating or cooling system
- Contact with live parts during error status
- Operation of a unit with damaged power cord

### **Maintenance**

- Maintenance work on live parts.
- Execution of maintenance work by untrained/insufficiently qualified personnel
- Electrical safety analysis during annual maintenance not performed

### **Trouble-shooting and Repairs**

- Non-observance of warning messages in the Service Manual
- Trouble-shooting of live parts without specified safety measures
- Absence of a plausibility check to rule out erroneous inscription of electrical components
- Performance of repair work by untrained/insufficiently qualified personnel
- Inappropriate repairs which do not meet the quality standard specified by BINDER
- Use of replacement parts other than BINDER original replacement parts
- Electrical safety analysis not performed after repairs

## **1.11 Operating instructions**

Depending on the application and location of the chamber, the operator of the chamber must provide the relevant information for safe operation of the chamber in a set of operating instructions.



Keep these operating instructions with the chamber at all times in a place where they are clearly visible. They must be comprehensible and written in the language of the employees.

## **1.12 Measures to prevent accidents**

The operator of the chamber must observe the local and national regulations (for Germany: the rule "Operation of work equipment. Operation of refrigeration systems, heat pumps and refrigeration equipment", GUV-R 500 chap. 2.35) and take precautions to prevent accidents.

The manufacturer took the following measures to prevent ignition and explosions:

- **Indications on the type plate**  
See operating manual chap. 1.6.
- **Operating manual**  
An operating manual is available for each chamber.

- **Overtemperature monitoring**

The chamber is equipped with a temperature display, which can be read from outside.

The chamber is equipped with an additional safety controller (temperature safety device class 3.1 acc. to DIN 12880:2007). Visual and audible (buzzer) signals indicate temperature exceeding.

- **Safety, measurement, and control equipment**

The safety, measuring, and control equipment is easily accessible.

- **Electrostatic charge**

The interior parts are grounded.

- **Non-ionizing radiation**

Non-ionizing radiation is not intentionally produced, but released only for technical reasons by electrical equipment (e.g. electric motors, power cables, solenoids). The machine has no permanent magnets. If persons with active implants (e.g. pacemakers, defibrillators) keep a safe distance (distance of field source to implant) of 30 cm, an influence of these implants can be excluded with high probability.

- **Protection against touchable surfaces**

Tested according to EN ISO 13732-1:2008.

- **Floors**

See operating manual chap. 3.4 for correct installation

- **Cleaning**

See operating manual chap. 24.4.

- **Examinations**

The chamber has been inspected by the "Deutsche Gesetzliche Unfallversicherung e.V. (DGUV) (German Social Accident Insurance (DGUV))" (German Social Accident Insurance (DGUV), Testing and Certification Body for Foodstuffs and Packaging Industry in DGUV Test) and bears the GS mark. Not valid for UL chambers.

UL chambers: The chamber is certified by Underwriters Laboratories Inc.® according to the following standards: UL 61010-1, 3<sup>rd</sup> Edition, 2012-05, Rev. 2015-07, CAN/CSA-C22.2 No. 61010-1, 3<sup>rd</sup> Edition, 2012-05, Rev. 2015-07.



## 2. Chamber description

Cooling incubators KB ECO / KB ECO-UL are equipped with a multifunctional microprocessor display controller for temperature plus a digital display accurate to one-tenth of a degree.

### Use:

A high level of precision, reliability, and safety for all growth parameters ensures optimum incubation conditions. Moreover, the KBF-S ECO / KBF-S ECO-UL is designed for maximum usability – even in continuous operation year after year. It fulfills all technical and application-specific requirements arising in experimentation such as in the areas of biotechnology, medicine, the nutrition industry, pharmaceutical and cosmetics industries, botany, and zoology.

Two important temperature technologies have been combined to achieve perfect temperature control. The Peltier heating and refrigerating system, in conjunction with the APT.line™ preheating chamber technology, satisfies the unique prerequisites for attaining highly-precise temperature control and particularly short recovery times after opening the door.

### Heating:

The APT.line™ preheating chamber system guarantees high level of spatial and time-based temperature precision, thanks to the direct and distributed air circulation into the interior. The fan supports exact attainment and maintenance of the desired temperature accuracy.

### Cooling system:

The refrigerating system is distinguished by direct, precise, and rapid temperature conduction. Due to the Peltier cooling, shocks are omitted which would occur during start and stop of conventional refrigeration systems with a compressor.

The chamber is characterized by its low energy consumption.

Operation is environmentally friendly without climate-damaging refrigerants.

**Material:** The inner chamber, the pre-heating chamber and the interior side of the doors are all made of stainless steel V2A (German material no. 1.4301, US equivalent AISI 304). The housing is RAL 7035 powder-coated. All corners and edges are also completely coated.

All chamber functions are easy and comfortable to use thanks to their clear arrangement. Major features are easy cleaning of all chamber parts and avoidance of undesired contamination.

**Controller:** The efficient RD4 chamber controller is equipped with a multitude of operating functions, in addition to recorder and alarm functions. Set-point entry is easily accomplished directly via the chamber controller and is also possible directly with a computer via Intranet in connection with the APT-COM™ 4 Multi Management Software (option, chap. 22.1). The chamber comes equipped with an Ethernet serial interface for computer communication and with a USB interface. In addition, the BINDER APT-COM™ 4 Multi Management Software permits networking up to 100 chambers and connecting them to a PC for controlling and programming, as well as recording and representing temperature data. For further options, see chap. 26.5.

The chambers are equipped with four castors. Both front castors can be easily locked via the attached brakes.

Temperature control range: 20 °C below ambient temperature up to 70 °C / 158 °F.

## 2.1 Chamber overview

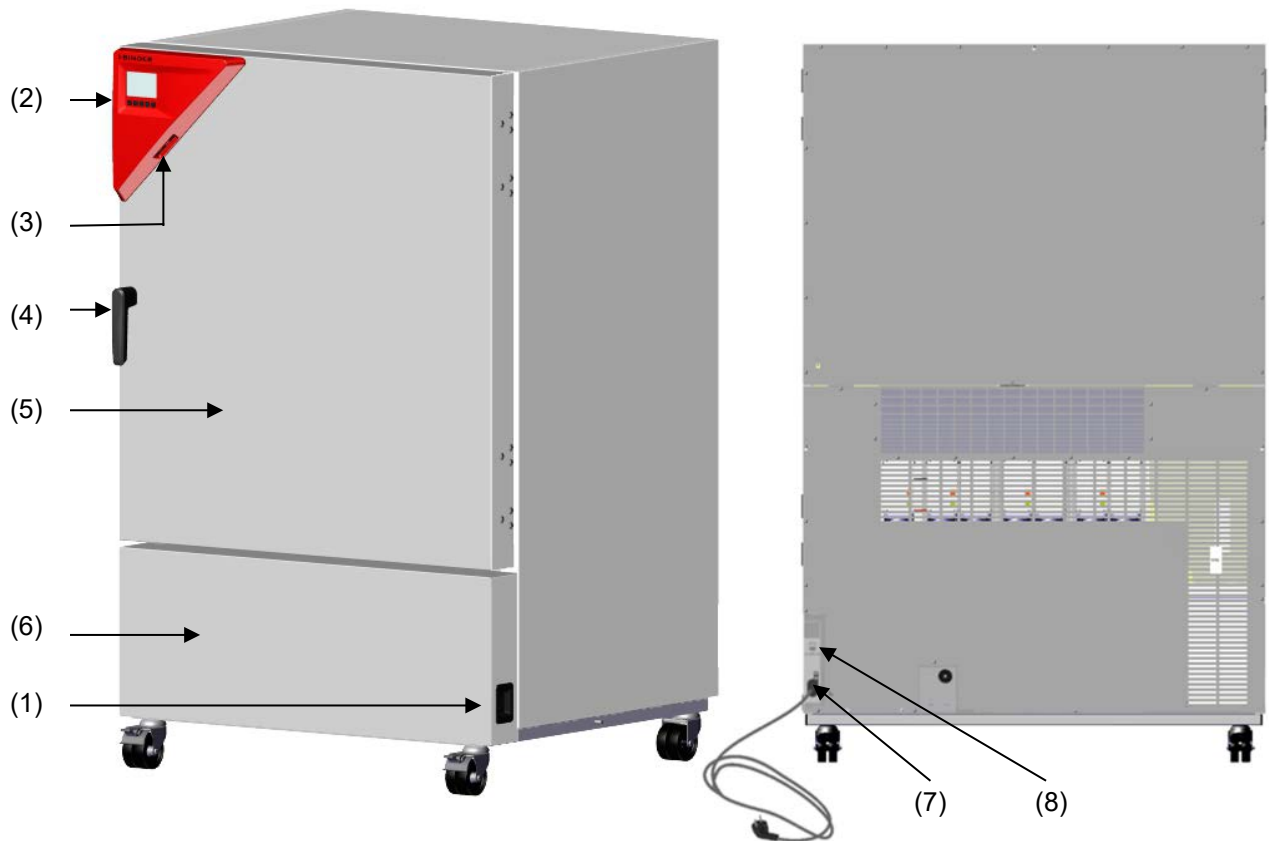

Figure 4: Cooling incubator KB ECO / KB ECO-UL size 240

- (1) Main power switch
- (2) Instrument panel with RD4 chamber controller and USB interface
- (3) USB interfaces
- (4) Door handle
- (5) Chamber door
- (6) Location of Peltier modules
- (7) Power cable
- (8) Ethernet interface





### 3. Completeness of delivery, transportation, storage, and installation

#### 3.1 Unpacking, and checking equipment and completeness of delivery

After unpacking, please check the chamber and its optional accessories, if any, based on the delivery receipt for completeness and for transportation damage. Inform the carrier immediately if transportation damage has occurred.

The final tests of the manufacturer may have caused traces of the shelves on the inner surfaces. This has no impact on the function and performance of the chamber.

Please remove any transportation protection devices and adhesives in/on the chamber and on the doors and remove the operating manuals and accessory equipment.

   	 <b>CAUTION</b>
<p><b>Risk of injury and damages by lifting heavy loads and by sliding or tilting of the chamber due to improper lifting.</b></p> <p><b>Injuries, damage to the chamber.</b></p> <ul style="list-style-type: none"> <li>⊘ Do NOT lift or transport the chamber using the door, the handle, or the lower housing.</li> <li>➤ Lift chambers size 240 from the pallet at the four lower corners with the aid of six people or with a fork lifter. Set the fork lifter only from the front or rear in the middle of the chamber.</li> <li>➤ Lift the chambers sizes 720 and 1020 from the pallet using technical devices (fork lifter). Set the fork lifter only from the front or rear in the middle of the chamber.</li> <li>⊘ Do NOT set the fork lifter from the chamber side.</li> </ul>	

If you need to return the chamber, please use the original packing and observe the guidelines for safe lifting and transportation (chap. 3.2).

For disposal of the transport packing, see chap. 25.1.

#### Note on second-hand chambers (Ex-Demo-Units):

Second-hand chambers are chambers that were used for a short time for tests or exhibitions. They are thoroughly tested before resale. BINDER ensures that the chamber is technically sound and will work flawlessly.

Second-hand chambers are marked with a sticker on the chamber door. Please remove the sticker before commissioning the chamber.

#### 3.2 Guidelines for safe lifting and transportation

The front castors of the chambers can be blocked by brakes. Please move the chambers with castors only when empty and on an even surface, otherwise the castors may be damaged. After operation, please observe the guidelines for temporarily decommissioning the chamber (chap. 25.2).

	<div style="background-color: yellow; text-align: center; padding: 5px;"><b>! CAUTION</b></div> <p><b>Risk of injury and damages by lifting heavy loads and by sliding or tilting of the chamber due to improper transportation.</b></p> <p><b>Injuries, damage to the chamber.</b></p> <ul style="list-style-type: none"> <li>➤ Transport the chamber in its original packaging only.</li> <li>➤ For moving or shipping, secure the constant climate chamber with transport straps.</li> <li>⊘ Do NOT lift or transport the chamber using the door, the handle, or the lower housing.</li> <li>➤ Lift chambers size 240 at the four lower corners with the aid of 6 people or with a fork lifter. Set the fork lifter only from the front or rear in the middle of the chamber.</li> <li>➤ Lift the chambers sizes 720 and 1020 using technical devices (fork lifter). Set the fork lifter only from the front or rear in the middle of the chamber.</li> <li>⊘ Do NOT set the fork lifter from the chamber side.</li> </ul>
---	---

- Permissible ambient temperature range during transport: -10 °C / 14 °F to +60 °C / 140 °F.

You can order transport packing for moving or shipping purposes from BINDER service.

### 3.3 Storage

Intermediate storage of the chamber is possible in a closed and dry room. Observe the guidelines for temporary decommissioning (chap. 25.2).

- Permissible ambient temperature range during storage: -10 °C / 14 °F to +60 °C / 140 °F
- Permissible ambient humidity: max. 70 % r.h., non-condensing.

When after storage in a cold location you transfer the chamber to its warmer installation site, condensation may form. Before start-up, wait at least one hour until the chamber has attained ambient temperature and is completely dry.



In case of a prolonged temporal decommissioning: Leave the chamber door open or remove the access port plugs.

### 3.4 Location of installation and ambient conditions

Set up the chamber on a flat, even surface, and in a well-ventilated, dry location and align it using a spirit level. The site of installation must be capable of supporting the chamber's weight (see technical data, chap.26.4). The chambers are designed for setting up inside a building (indoor use).

	<div style="background-color: #00aaff; color: white; text-align: center; padding: 5px;"><b>NOTICE</b></div> <p><b>Danger of overheating due to lack of ventilation.</b></p> <p><b>Damage to the chamber.</b></p> <ul style="list-style-type: none"> <li>⊘ Do NOT install the chamber in unventilated recesses.</li> <li>➤ Ensure sufficient ventilation for dispersal of the heat.</li> <li>➤ Observe the prescribed minimum distances when installing the chamber.</li> </ul>
---	--

Do not install or operate the chamber in potentially explosive areas.

	 <b>DANGER</b>
	<p><b>Danger of explosion due to combustible dusts or explosive mixtures in the vicinity of the chamber.</b></p> <p><b>Serious injury or death from burns and / or explosion pressure.</b></p> <ul style="list-style-type: none"> <li>⊘ Do NOT operate the chamber in potentially explosive areas.</li> <li>➤ KEEP explosive dust or air-solvent mixtures AWAY from the vicinity of the chamber.</li> </ul>

### Ambient conditions

- Permissible ambient temperature range during operation: +18 °C / 64.4 °F to +32 °C / 89.6 °F. At elevated ambient temperature values, fluctuations in temperature can occur.

	<p>The ambient temperature should not be substantially higher than the indicated ambient temperature of +22 °C +/- 3 °C / 71.6 °F +/- 5.4 °F to which the specified technical data relate. Deviations from the indicated data are possible for other ambient conditions.</p>
---	--

	<p>With each degree of ambient temperature &gt;25 °C / 77 °F, the refrigeration power decreases by 1.5 K.</p>
---	---

- Permissible ambient humidity: 70 % r.h. max., non-condensing

When operating the chamber at temperature set-points below ambient temperature, high ambient humidity may lead to condensation on the chamber.

- Installation height: max. 2000 m / 6562 ft. above sea level.

### Minimum distances

- When placing several chambers of the same size side by side, maintain a minimum distance of 250 mm / 9.84 in between each chamber.
- Wall distances: rear 100 mm / 3.9 in, sides 180 mm / 7.1 in.
- Spacing above the chamber of at least 100 mm / 3.9 in must also be accounted for.

Maximum load of the top of the housing: 15 kg / 33 lb. The chambers are NOT intended for stacking.

	<b>NOTICE</b>
	<p><b>Danger by stacking.</b></p> <p><b>Damage to the chambers.</b></p> <ul style="list-style-type: none"> <li>⊘ Do NOT place the chambers on top of each other.</li> </ul>

### Other requirements

To completely separate the chamber from the power supply, you must disconnect the power plug. Install the chamber in a way that the power plug is easily accessible and can be easily pulled in case of danger.

For the user there is no risk of temporary overvoltages in the sense of EN 61010-1:2010.

With an increased amount of dust in the ambient air, clean the Peltier fan grid (by suction or blowing) several times a year.

Avoid any conductive dust in the ambience according to the chamber layout complying with pollution degree 2 (IEC 61010-1).

Install the chamber in a way that freshwater can be easily accessed for filling

## 4. Installation and connections

### 4.1 Condensate collection pan

Emerging condensate is collected in a condensate collection pan which is mounted under the chamber. If necessary, the pan can be removed and emptied at any time.

Under normal operating conditions (e.g. incubation of 100 Petri dishes at 25 ° C) there is so little condensate that it will evaporate in the condensate collection pan so that the collection pan does not have to be emptied. Under operating conditions with increased condensation, the condensate collecting tray should be checked weekly and, if necessary, emptied.

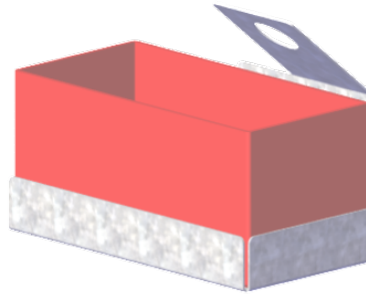

Figure 5: Condensate collection pan

#### Installation of the condensate collection pan

Hang the condensate collection pan on the chamber rear and guide the hose through the latch of the holder.

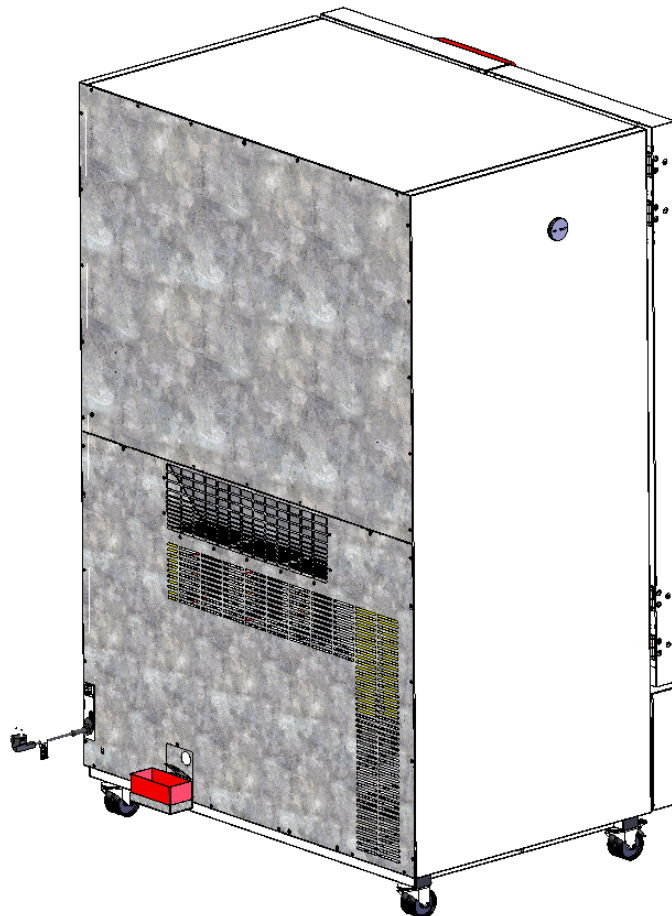



Figure 6: KB ECO 720 with mounted condensate collection pan

## 4.2 Electrical connection

The chambers are supplied ready for connection. They come with a fixed power connection cable of at least 1800 mm / 70.87 in in length.

Model version	Power plug	Voltage +/-10% at the indicated power frequency	Current type	Chamber fuse
KB ECO 240 KB ECO 720 KB ECO 1020	Grounded plug CEE 7/7	200-230 V at 50 Hz 200-230 V at 60 Hz	1N~	16 Amp
KB ECO 240-UL KB ECO 720-UL KB ECO 1020-UL	NEMA 5-20P	100-120 V at 50Hz 100-120 V at 60Hz	1N~	16 Amp

- The domestic socket must also provide a protective conductor. Make sure that the connection of the protective conductor of the domestic installations to the chamber's protective conductor meets the latest technology. The protective conductors of the socket and plug must be compatible!

	 <b>DANGER</b>
	<p><b>Electrical hazard due to missing protective conductor connection.</b> <b>Deadly electric shock.</b></p> <ul style="list-style-type: none"> <li>➤ Make sure that the chamber's power plug and the power socket match and securely connect the electrical protective conductors of the chamber and the house installation.</li> </ul>

- Only use original connection cables from BINDER according to the above specification.  
UL chambers: Use only a UL Listed Power supply cord (UL category ELBZ), SJT 3x14 AWG (2.08 mm<sup>2</sup>); C13L. For outside USA use a certified power supply cord according to national requirements.
- Prior to connection and start-up, check the power supply voltage. Compare the values to the specified data located on the chamber's type plate (left chamber side, bottom right-hand, see chap. 1.6).

	<b>NOTICE</b>
	<p><b>Danger of incorrect power supply voltage due to improper connection.</b> <b>Damage to the chamber.</b></p> <ul style="list-style-type: none"> <li>➤ Check the power supply voltage before connection and start-up.</li> <li>➤ Compare the power supply voltage with the data indicated on the type plate.</li> </ul>



- When connecting, please observe the regulations specified by the local electricity supply company as well as the local or national electrical regulations (VDE directives for Germany).
- Observe a sufficient current protection according to the number of devices that you want to operate. We recommend the use of a residual current circuit breaker.
- Pollution degree (acc. to IEC 61010-1): 2
- Installation category (acc. to IEC 61010-1): II

See also electrical data (chap. 26.4).

	<p>To completely separate the chamber from the power supply, you must disconnect the power plug. Install the chamber in a way that the power plug is easily accessible and can be easily pulled in case of danger.</p>
---	--

**Remark when operating the chamber with a power frequency of 60 Hz:**

When connected to a power supply 1N~ with a frequency of 60 Hz, a leakage current of more than 3.5 mA is possible. If grounding through the power cable is insufficient or missing, the leakage current may flow through the user's body. Correct installation of the professional grade power socket provided by the user safely avoids this. Before connecting the chamber to the socket, please check its grounding contact type plug for appropriate construction and whether it is undamaged.

	 <b>DANGER</b>
	<p><b>Electrical hazard by high leakage current.</b>  <b>Deadly electric shock.</b></p> <p>➤ Earth connection is essential before connecting supply. Check socket before inserting plug.</p>

## 5. Functional overview of the RD4 chamber controller

The RD4 chamber controller controls the temperature inside the chamber:

You can enter the desired set point values in the “**Set points**” menu directly at the controller or use the APT-COM™ 4 Multi Management Software (option) specially developed by BINDER.

The controller offers various notifications and alarm messages with visual and audible indication. All controller settings remain valid until the next manual change. They are stored also after turning off the chamber.

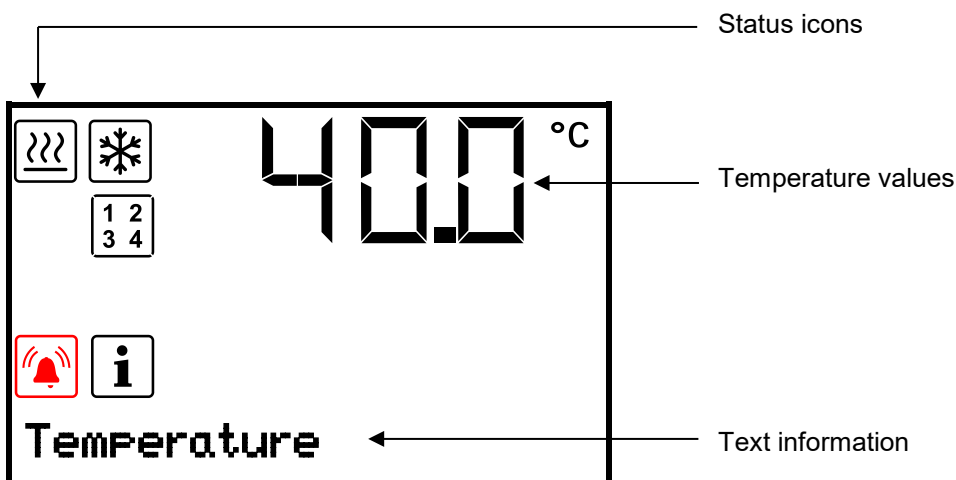











Figure 7: Normal display of the RD4 controller (sample values)

### Status icons in the controller display

Icon	Signification	Icon	Signification
	Heating active		Display of activated special controller functions. 2 = Idle mode
	Refrigeration active		Collective alarm
	Information		



## Functional controller keys

Icon	Signification	Function
	<b>Arrow-up button</b>	<ul style="list-style-type: none"> <li>Navigate between menus, submenus, other functions</li> <li>In the setting menu: change setting, decrease value</li> </ul>
	<b>Arrow-down button</b>	<ul style="list-style-type: none"> <li>Navigate between menus, submenus, other functions</li> <li>In the setting menu: change setting, increase value</li> </ul>
	<b>OK button</b>	<ul style="list-style-type: none"> <li>Select menu, submenu, function</li> <li>In the setting menu: Confirm entry</li> </ul>
	<b>Back button</b>	Back to previous menu level
	<b>Standby button</b>	no function

### 5.1 Menu structure of the controller and access levels

Starting from **Normal display**, navigate between the menus with the **arrow buttons**.

With the **OK button** you enter the setting of further subordinate menu functions.

With the **Back button** you go back to the previous function and finally back to Normal display.

The available functions depend on the current dependent on the current **authorization** "User", "Admin" or "Service", for which the entry of a password may be required, depending on the setting.

You can set passwords for different access levels:

- **User:** The password enables access to the standard operating functions. Factory setting is 00 00 (no password assigned).
- **Admin:** The password enables access to advanced controller functions and settings. Factory setting is 00 01.
- **Service:** The password enables access to all controller functions (for BINDER Service only).

As soon as a password has been assigned, access to the respective functions is blocked and only available after entering the correct password.

Menu	Required access level	Functions
<b>Setpoints</b>	"User"	<ul style="list-style-type: none"> <li>Temperature set-point setting</li> <li>Setting the safety controller</li> <li>Activating/deactivating operating mode "Idle mode"</li> </ul>
<b>Chamber info</b>	Any user	<ul style="list-style-type: none"> <li>Configuration display (setup information, controller hardware and software, analog inputs)</li> <li>Display of interface configuration (e.g. MAC address, IP address)</li> </ul>
<b>Settings</b>	"Admin"	<ul style="list-style-type: none"> <li>General controller settings (date, time, menu language, temperature unit, display brightness...)</li> <li>Network settings</li> <li>Setting the data logger storage interval</li> <li>Setting the tolerance range limits and delay time for tolerance range alarm</li> <li>Self-test function</li> <li>Password changing for User and Admin</li> </ul>

Menu	Required access level	Functions
<b>Service</b>	"Service"	<ul style="list-style-type: none"> <li>• Configuration settings (only for BINDER Service)</li> <li>• Password changing for User and Admin</li> </ul>
<b>USB</b>	Export: Any user Import: "Admin"	<ul style="list-style-type: none"> <li>• Export of configuration, logger, and service data</li> <li>• Import of configuration data</li> </ul>

Unless noted otherwise, the figure in this manual show the functional range, which is available for the user with "Admin" authorization level

Note: When specifying the path to the respective function, the possibly required entry of a password is not listed

## 5.2 Performance during and after power failures

During a power failure, all controller functions are shut down.

After the power returns, all functions return to the same status the chamber had before power failure. The set-points are immediately resumed.

If during power failure an alarm has occurred (tolerance range, safety controller etc.), confirm the alarm. See chap. 14.

## 6. Start up

After connecting the power supply, turn on the chamber by its main power switch (1). The lit pilot lamp shows the chamber is ready for operation.

The controller shows normal display and controls temperature to the last entered values.

Warming chambers may release odors in the first few days after commissioning. This is not a quality defect. To reduce odors quickly we recommend heating up the chamber to its nominal temperature for one day and in a well-ventilated location.



**WARNING:** If customer should use a BINDER chamber running in non-supervised continuous operation, we strongly recommend in case of inclusion of irrecoverable specimen or samples to split such specimen or samples and store them in at least two chambers, if this is feasible.

If the function "Language selection at restart" has been activated (chap. 12.5, factory setting ON), the following settings are checked upon start up:

- **Menu language** (chap. 12.1):  
Use the **arrow buttons** to select the desired language, confirm with the **OK button**
- **Temperature unit** (chap. 12.2):  
Use the **arrow buttons** to select the desired temperature unit, confirm with the **OK button**.
- **Current date** (chap. 12.3), format DD MM YYYY:  
Use the **arrow buttons** to set the day, continue with the **OK button**.  
Use the **arrow buttons** to set the month, continue with the **OK button**.  
Use the **arrow buttons** to set the year, confirm with the **OK button**
- **Current time** (chap. 12.4), format HH:MM:  
Use the **arrow buttons** to set the hours, continue with the **OK button**.  
Use the **arrow buttons** to set the minutes, confirm with the **OK button**

## 7. Temperature set-point entry

Required access level: "User".

	Setting range	Control range
Temperature	-10 °C / 14 °F up to 70 °C / 158 °F.	20 °C below ambient temperature up to 70 °C / 158 °F



With safety controller mode "**Limit**", adapt the safety controller always when you changed the temperature set-point. Set the safety controller value by approx. 2 °C to 5 °C above the temperature set-point (chap. 11.2).  
Recommended setting: safety controller mode "**Offset**" with safety controller value 2 °C.

### 7.1 Temperature set-point entry

Path: **Normal display**  **Setpoints**  **Temperature**

Press the **OK button** to enable the setting.

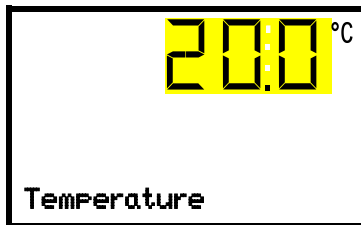

Temperature setting.  
The current setting flashes. Enter the desired set-point with the **arrow buttons**.  
Confirm the entry with the **OK button**.

With the **Back button** you can go back to the "**Setpoints**" submenu and, repeatedly pressing it, to **Normal display**.

## 8. Automatic setpoint switchover

### Control modes

With the setpoint switchover, an automatic switchover of the setpoint, e.g. at weekends or on a specific date, can be programmed. To do this, an alternative setpoint is entered in this menu. By entering a weekday and / or date and time, the setpoint changeover works reliably even in the event of an intermittent power failure.

**Cyclic control:** The alternative setpoint is regularly activated and deactivated on a specific weekday / time. This control mode is suitable e.g. for weekends.

**Control by date:** The alternative setpoint is activated and deactivated once on an entered date / time. This control mode is suitable for special dates, e.g. holidays.

### Indication

As soon as the alternative setpoint is active, the information text "Setpoint switchover active" is shown alternating with "Temperature" in Normal Display

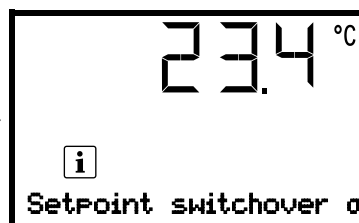
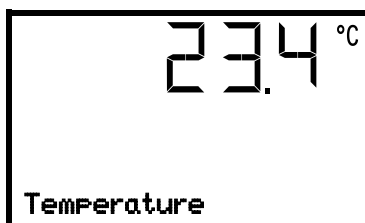

## Safety controller

The safety controller settings remain in effect. Please note that with the set-point type offset, the automatic switchover can trigger a safety controller alarm. Recommended setting: Setpoint type "Limit" above the higher of the two set-points.

The tolerance band alarm is always effective.

## Setting

Path: **Normal display**   **Setpoint switchover**

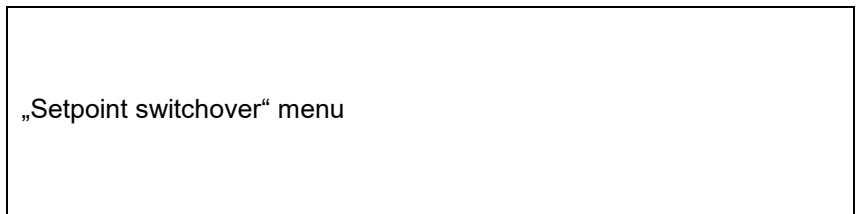

With the **OK button** you can change to activate/deactivate and configure the Control by date.

With the **OK button + arrow-down button** you can change to activate/deactivate and configure the der Cyclic control.

In state of delivery, both control modes are deactivated.

As soon as one of the control is activated, setpoint switchover becomes enabled.

## 8.1 Control by date

In this menu you can enter date and time at which the alternative setpoint should be activated and deactivated once.

Path: **Normal display**   **Setpoint switchover**  **Date controlled**

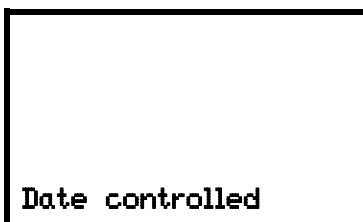

Press the **OK button** to enable the setting.

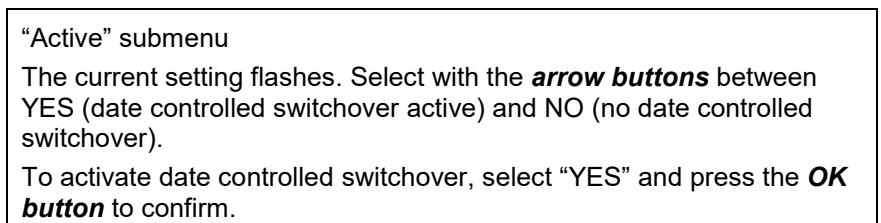
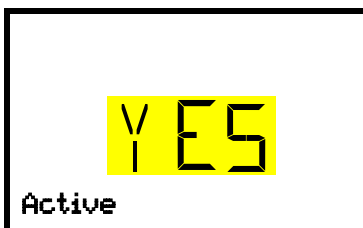

With the **arrow-down button** you can change to enter the **date to activate the alternative setpoint**. Press the **OK button** to enable the setting.

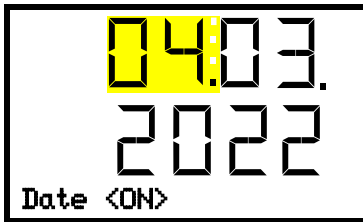

Setting the date: day  
The current setting flashes. Enter the desired day with the **arrow buttons**.  
Confirm the entry with the **OK button**.



Setting the date: month  
The current setting flashes. Enter the desired month with the **arrow buttons**.  
Confirm the entry with the **OK button**.



Setting the date: year  
The left two digits are flashing. Enter the first two digits of the desired year with the **arrow buttons**.  
Confirm the entry with the **OK button**.

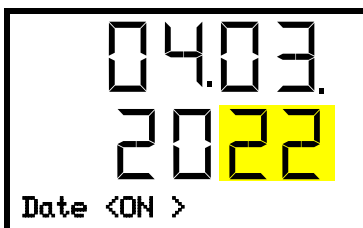

Setting the date: year  
The right two digits are flashing. Enter the last two digits of the desired year with the **arrow buttons**.  
Confirm the entry with the **OK button**.

With the **arrow-down button** you can change to enter the **time to activate the alternative setpoint**. Press the **OK button** to enable the setting.

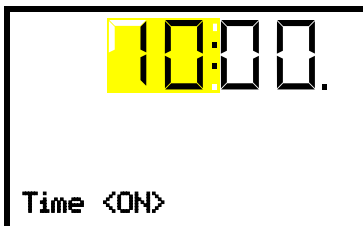

Setting the time: hours  
The current setting flashes. Enter the desired hour with the **arrow buttons**.  
Confirm the entry with the **OK button**.

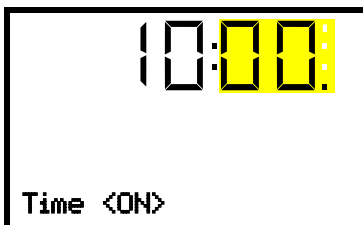

Setting the time: minutes  
The current setting flashes. Enter the desired minutes with the **arrow buttons**.  
Confirm the entry with the **OK button**.

With the **arrow-down button** you can change to enter the **date to deactivate the alternative setpoint**. Press the **OK button** to enable the setting

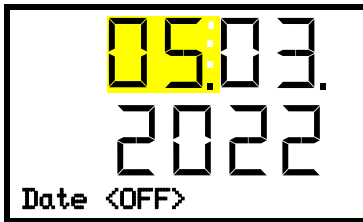

Setting the date: day

The current setting flashes. Enter the desired day, month, and year with the **arrow buttons** and confirm all entries each entry with the **OK button**.

With the **arrow-down button** you can change to enter the **time to deactivate the alternative setpoint**. Press the **OK button** to enable the setting

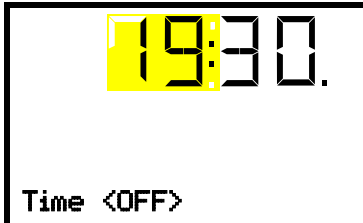

Setting the time: hours

The current setting flashes. Enter the desired hour and minutes with the **arrow buttons** and confirm all entries each entry with the **OK button**.

With the **Back button** you can go back to the “**Setpoint switchover**” submenu and, repeatedly pressing it, to **Normal display**.

## 8.2 Regular cyclic control

In this menu you can enter the day of the week and the time at which the alternative setpoint should be regularly activated and deactivated.

Path: **Normal display**   **Setpoint switchover**   **Cyclic**

Press the **OK button** to enable the setting.

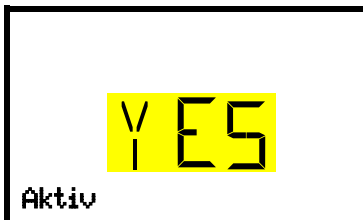

“Active” submenu

The current setting flashes. Select with the **arrow buttons** between YES (cyclic control active) and NO (no cyclic control).

To activate cyclic control, select “YES” and press the **OK button** to confirm.

With the **arrow-down button** you can change to enter the **day of the week to activate the alternative setpoint**. Press the **OK button** to enable the setting

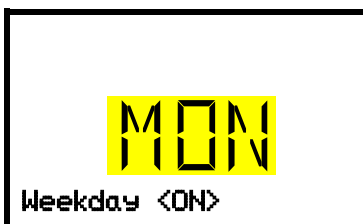

Setting the weekday: “Weekday <ON>” submenu

The current setting flashes. Use the **arrow buttons** to select the desired day of the week to activate the alternative setpoint

Sun / Mon / Tue / Wed / Thu / Fri / Sat  
and confirm the entry with the **OK button**.

With the **arrow-down button** you can change to enter the **time to activate the alternative setpoint**. Press the **OK button** to enable the setting

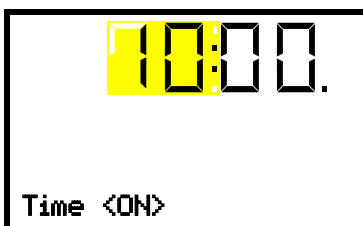

Setting the time: hours

The current setting flashes. Enter the desired hour with the **arrow buttons**.

Confirm the entry with the **OK button**.

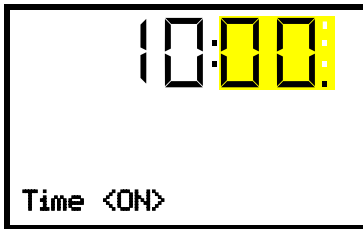

Setting the time: minutes  
 The current setting flashes. Enter the desired minutes with the **arrow buttons**.  
 Confirm the entry with the **OK button**.

With the **arrow-down button** you can change to enter the day of the week to deactivate the alternative setpoint. Press the **OK button** to enable the setting



Setting the weekday: "Weekday <OFF>" submenu  
 The current setting flashes. Use the **arrow buttons** to select the desired day of the week to deactivate the alternative setpoint  
 Sun / Mon / Tue / Wed / Thu / Fri / Sat  
 and confirm the entry with the **OK button**.

With the **arrow-down button** you can change to enter the **time to deactivate the alternative setpoint**. Press the **OK button** to enable the setting



Setting the time: hours  
 The current setting flashes. Enter the desired hour and minutes with the **arrow buttons** and confirm all entries each entry with the **OK button**.

With the **Back button** you can go back to the "**Setpoint switchover**" submenu and, repeatedly pressing it, to **Normal display**.

### 8.3 Entry of the alternative temperature set-point

The alternative temperature setpoint is activated or deactivated again at the switching times set via the control by date and / or the cyclic control.

Path: **Normal display**   **Setpoint switchover**    **Temperature**

Press the **OK button** to enable the setting.

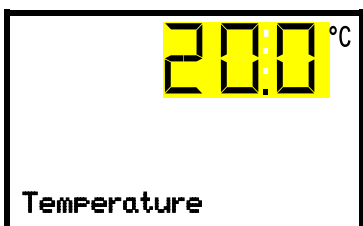

Temperature setting.  
 The current setting flashes. Enter the desired set-point with the **arrow buttons**.  
 Confirm the entry with the **OK button**.

With the **Back button** you can go back to the "**Setpoint switchover**" submenu and, repeatedly pressing it, to **Normal display**.

## 8.4 Activating / deactivating “Idle mode” function

You can also activate the " Idle mode " function for the switching times set via the control by date and / or the cyclic control. This function is used to switch off all device functions except for the controller. With operating mode “Idle mode”, heating, refrigeration, and the fan are deactivated.

Path: **Normal display**   **Setpoint switchover**     **Functions on/off**

You can define the switching state of up to four controller functions. Function 2 is “Idle mode”, while with this chamber type the other controller functions are without function.

The functions are displayed from left to right.

**Example:** Function 2 “Idle mode” activated = 0100. Function 2 “Idle mode” deactivated = 0000.

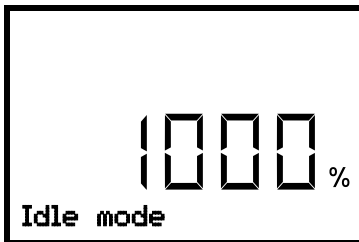

Submenu “**Functions on/off**”.

This view shows the switching states of the four available functions.

“1” = Activated function

“0” = Deactivated function

Press the **OK button** to access the first individual function. Then press the **arrow-down button**, to access the “Idle mode” function.

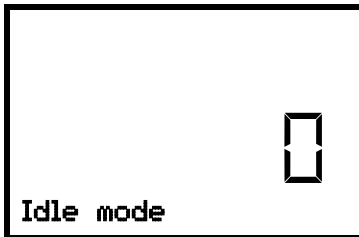

Function 2 “Idle mode”.

The current switching state is shown (example).

Press the **OK button** to enable the setting.

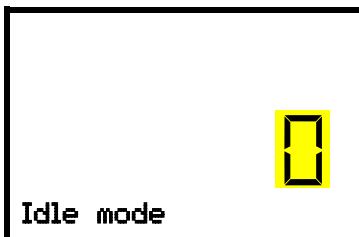

Setting function 2 “Idle mode”.

The current setting flashes. Use the **arrow buttons** to select between 0 (deactivated function) and 1 (activated function).

Confirm the setting with the **OK button**.

With the **Back button** you can go back to the “**Setpoint switchover**” submenu and, repeatedly pressing it, to **Normal display**.



## 9. Special controller functions – Idle mode

Required access level: "User".

Path: **Normal display**  **Setpoints**    **Functions on/off**

You can define the switching state of up to four controller functions.

Function 2 "Idle mode" serves to deactivate all chamber functions except the controller. With operating mode "Idle mode", heating, refrigeration, and the fan are deactivated.

With this chamber type the other controller functions are without function.

The functions are displayed from left to right.

**Example:** Function 2 "Idle mode" activated = 0100. Function 2 "Idle mode" deactivated = 0000.

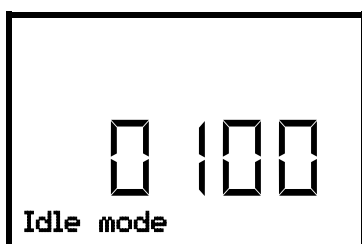

Submenu "**Functions on/off**".

This view shows the switching states of the four available functions.

"1" = Activated function

"0" = Deactivated function

Press the **OK button** to access the first individual function. Then press the **arrow-down button**, to access the "Idle mode" function. This is the only adjustable function with the present chamber type.

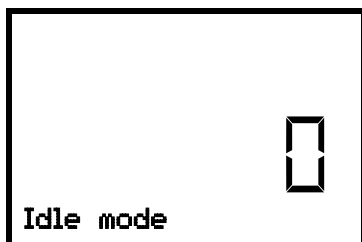

Function 2 "Idle mode".

The current switching state is shown (example).

Press the **OK button** to enable the setting.

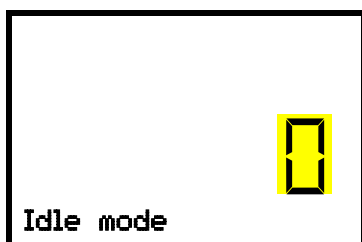

Setting function 2 "Idle mode".

The current setting flashes. Use the **arrow buttons** to select between 0 (deactivated function) and 1 (activated function).

Confirm the setting with the **OK button**.

With the **Back button** you can go back to the "**Functions on/off**" submenu and, repeatedly pressing it, to **Normal display**.

In Normal display the activated functions are indicated by an icon showing the number of the respective function. The "Info" icon flashes slowly. While it is lit, the lower text informs about the activated functions.

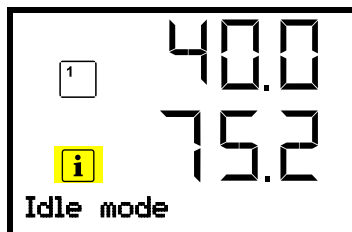
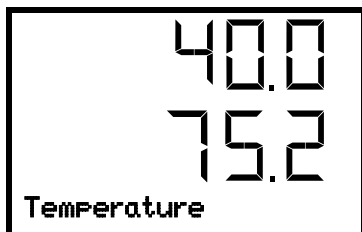

Example:

Normal display with activated function 2 "Idle mode".

## 10. Password

### 10.1 Password request

To access menus for which access is restricted, you must enter the corresponding password.

After calling the appropriate menu function with the **OK button** the password request appears.

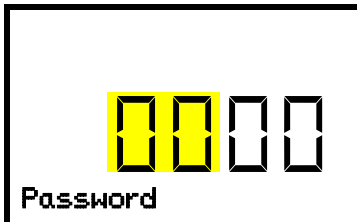

Password request.

The left two digits are flashing. Enter the desired numbers with the **arrow buttons**.

Confirm the setting with the **OK button**.

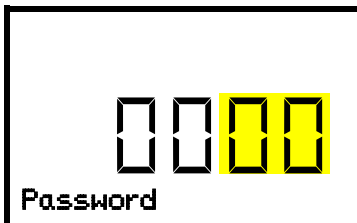

Password request.

The right two digits are flashing. Enter the desired numbers with the **arrow buttons**.

Confirm the setting with the **OK button**.

Upon entering an incorrect password, the message "Wrong password" is displayed.

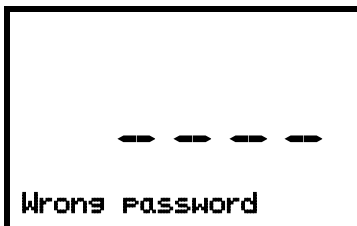

Display "Wrong password".

After 3 seconds the controller changes again to the password entry.

Enter the correct password.

Following correct password entry, you can access the desired menu function.

## 10.2 Assign and modify a password

In this menu you can assign and modify the passwords of the “User” and “Admin” access levels.

Required access level: “Admin”.



Keep the password well in mind. There is no access to the corresponding menu functions without the correct password.

### 10.2.1 Assign and modify the User password

Path: **Normal display**    **Settings**  **Chamber**     **Password User**

Press the **OK button** to enable the setting.

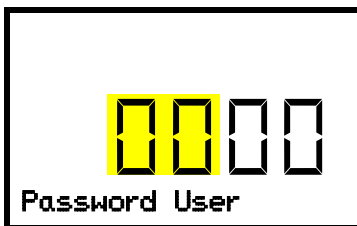

Setting the User password.  
The left two digits are flashing. Enter the desired numbers with the **arrow buttons**.  
Confirm the setting with the **OK button**.

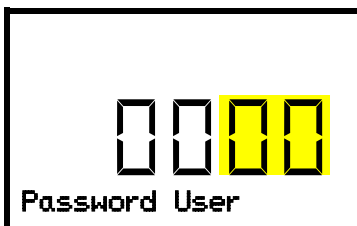

Setting the User password.  
The right two digits are flashing. Enter the desired numbers with the **arrow buttons**.  
Confirm the setting with the **OK button**.

With the **arrow-down button** you can now proceed to enter the Admin password.

With the **Back button** you can go back to the “Chamber” submenu and, repeatedly pressing it, to **Normal display**.

### 10.2.2 Assign and modify the Admin password

Path: **Normal display**    **Settings**  **Chamber**     **Password Admin**

Press the **OK button** to enable the setting.

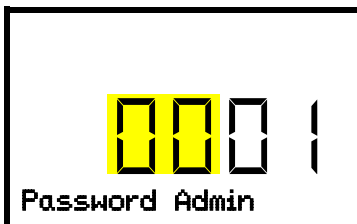

Setting the Admin password.  
The left two digits are flashing. Enter the desired numbers with the **arrow buttons**.  
Confirm the setting with the **OK button**.

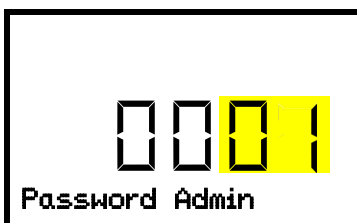

Setting the Admin password.  
The right two digits are flashing. Enter the desired numbers with the **arrow buttons**.  
Confirm the setting with the **OK button**.

With the **Back button** you can go back to the “Chamber” submenu and, repeatedly pressing it, to **Normal display**.

## 11. Temperature safety devices

### 11.1 Over temperature protective device (class 1)

The chamber is equipped with an internal temperature safety device, class 1 acc. to DIN 12880:2007. It serves to protect the chamber and prevents dangerous conditions caused by major defects.

If a temperature of approx. 90 °C / 194 °F is reached, the over temperature protective device permanently turns off the chamber. The user cannot restart the device again. The protective cut-off device is located internally. Only a service specialist can replace it. Therefore, please contact an authorized service provider or BINDER Service.

### 11.2 Overtemperature safety controller class 3.1

The chambers are regularly equipped with an electronic overtemperature safety controller (temperature safety device class 3.1 according to DIN 12880:2007). If an error occurs, the safety controller performs a regulatory function.

Please observe the regulations applicable to your country (for Germany: DGUV guidelines 213-850 on safe working in laboratories, issued by the employers' liability insurance association).

The overtemperature safety controller serves to protect the chamber, its environment and the contents from exceeding the maximum permissible temperature. In the case of an error, it limits the temperature inside the chamber to the entered safety controller value. This condition (state of alarm) is indicated visually and additionally with an audible alert if the buzzer is enabled (chap. 14.2). The alarm persists until the chamber cools down below the configured safety controller value and the alarm is reset on the controller.



Check the setting regularly and adjust it following changes of the temperature set-point or charge.



The safety controller only activates after the set-point has been reached once.

You can set the **safety controller mode** to "Limit" or "Offset".

- **Limit:** Limit value, absolute maximum permitted temperature value

This setting offers high safety as a defined temperature limit will not be exceeded. It is important to adapt the safety controller value after each modification of the temperature set-point. Otherwise, the limit could be too high to ensure efficient protection, or, in the opposite case, it could prevent the controller from reaching an entered set-point outside the limit range.

- **Offset:** Offset value, maximum overtemperature above any active temperature set point. The resulting maximum temperature changes internally and automatically with every temperature set-point change.

#### Example:

Desired temperature value: 40 °C, desired safety controller value: 45 °C.

Possible settings for this example:

Temperature set point	Safety controller mode	Safety controller value
40 °C	Limit	Limit value 45 °C
	Offset	Offset value 5 °C

### 11.2.1 Setting the safety controller mode

Required access level: "User".

Path: **Normal display**  **Setpoints**    **Safety controller**  **Mode**

Press the **OK button** to enable the setting.

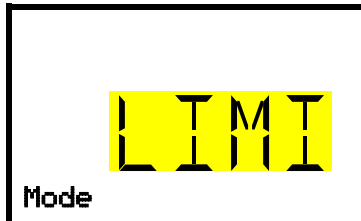

Setting the safety controller mode

The current setting flashes. Use the **arrow buttons** to select between LIMI (Limit) and OFFS (Offset).

Confirm the setting with the **OK button**.

With the **arrow-down button** you proceed to setting the safety controller value (chap. 11.2.2)

With the **Back button** you can go back to the "**Safety controller**" submenu and, repeatedly pressing it, to **Normal display**.

### 11.2.2 Setting the safety controller value

Required access level: "User".

The desired safety controller mode must be selected first (chap. 11.2.1). Depending on the mode setting, one of the following setting menus will appear.

Path: **Normal display**  **Setpoints**    **Safety controller**   **Limit or Offset**

Press the **OK button** to enable the setting.

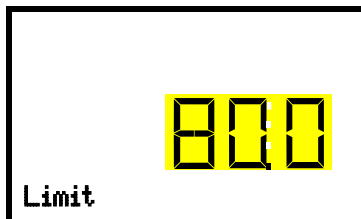

Setting the safety controller value with "Limit" safety controller mode.

The current value flashes. Enter the desired limit value with the **arrow buttons**.

Confirm the entry with the **OK button**.

or



Setting the safety controller value with "Offset" safety controller mode.

The current value flashes. Enter the desired offset value with the **arrow buttons**.

Confirm the entry with the **OK button**.

With the **Back button** you can go back to the "**Safety controller**" submenu and, repeatedly pressing it, to **Normal display**.



Regularly check the settings of the safety controller mode and value.

Set the safety controller value by approx. 2 °C to 5 °C above the desired temperature set-point.

### 11.2.3 Message and measures in the state of alarm

The state of alarm is indicated visually in Normal display. If the buzzer is enabled (chap. 14.2) there is an additional audible alert. The heating turns off. As soon as the inner chamber temperature has cooled down below the safety controller value, the heating is released and temperature control continues.

In Normal display a text message indicates the alarm cause. The “collective alarm” icon is lit. If the audible alarm is activated, the buzzer sounds. Press the **OK button** to mute the buzzer.

The alarm message “Safety controller” and the “Collective alarm” icon are displayed on the controller until you press the **OK button** on the controller **and** the inner chamber temperature has cooled down below the safety controller value.

- If the inner chamber temperature has already cooled down below the safety controller value when pressing the **OK button**, the alarm message “Safety controller” and the “Collective alarm” icon are reset together with the buzzer.
- If the state of alarm is still active when pressing the **OK button**, i.e. the inner chamber temperature is still above the safety controller value, first only the buzzer is reset. The alarm message “Safety controller” and the “Collective alarm” icon will disappear as soon as the inner chamber temperature falls below the safety controller value.

The alarm remains active until it is acknowledged on the controller and the inner temperature falls below the entered safety controller setpoint. Then the heating is released again.

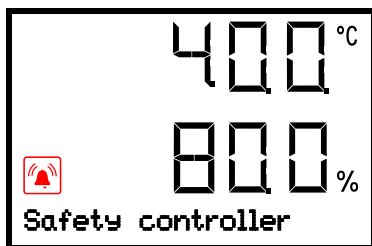

Normal display showing safety controller alarm (sample values)

#### Note:

When the safety controller class 3.1 had been activated you should disconnect the chamber from the power supply and have an expert examine and rectify the cause of the fault.

### 11.2.4 Function check

Check the safety controller at appropriate intervals for its functionality. It is recommended that the authorized operating personnel should perform such a check, e.g., before starting a longer work procedure.

## 12. General controller settings

The general settings can be accessed in the “**Settings**” submenu, which is available for users with “Service” or “Admin” authorization level. It serves to enter date and time, select the language for the controller menus and the desired temperature unit and to configure the controller’s communication functions.

The display of some network settings is available for all users in the “**Chamber info**” menu.

### 12.1 Selecting the controller’s menu language

The RD4 controller communicates by a menu guide using real words in German, English, French, Spanish, and Italian languages.

Required access level: “Admin”. Following start-up of the chamber (chap. 6), it is “User”.

Path: **Normal display**      **Settings**  **Chamber**    **Language\***

\* Following start-up of the chamber: **Sprache / Language / Langue / Idioma / Lingua**, depending on the language selected before turning off the chamber

Press the **OK button** to enable the setting.

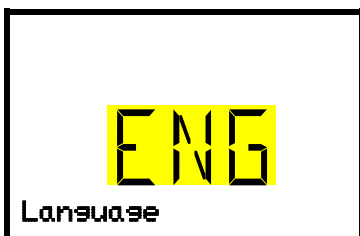

Setting the menu language (example: English).

The current setting flashes. Use the **arrow buttons** to select the desired language.

Confirm the entry with the **OK button**.

With the **arrow-down button (twice)** you can now change to the temperature unit setting.

With the **Back button** you can go back to the “**Chamber**” submenu and, repeatedly pressing it, to **Normal display**.

### 12.2 Selecting the temperature unit

Required access level: “Admin”. Following start-up of the chamber (chap. 6), it is “User”.

Path: **Normal display**      **Settings**  **Chamber**      **Temperature unit**

Press the **OK button** to enable the setting.

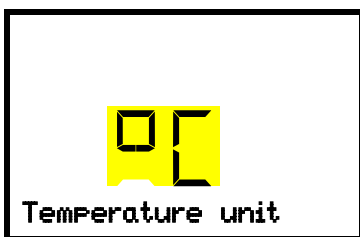

Setting the temperature unit

The current setting flashes. Use the **arrow buttons** to select between °C (degrees Celsius) and °F (degrees Fahrenheit).

Confirm the entry with the **OK button**.

You can change the temperature unit between °C and °F.

If the unit is changed, all values are converted accordingly



C = degree Celsius

0 °C = 31°F

Conversion:

F= degree Fahrenheit

100 °C = 212°F

[value in °F] = [value in °C] \* 1,8 + 32

With the **Back button** you can go back to the “**Chamber**” submenu and, repeatedly pressing it, to **Normal display**.

## 12.3 Setting the current date

Required access level: "Admin". Following start-up of the chamber (chap. 6), it is "User".

Path: **Normal display** ▾ ▾ ▾ ▾ ▾ **Settings**  **Chamber**  **Date**

Press the **OK button** to enable the setting.



Setting the date: day  
The current setting flashes. Enter the current day with the **arrow buttons**.  
Confirm the entry with the **OK button**.

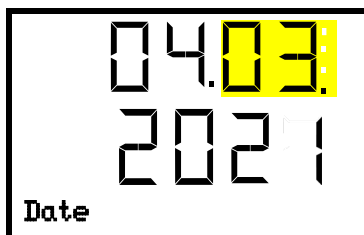

Setting the date: month  
The current setting flashes. Enter the current month with the **arrow buttons**.  
Confirm the entry with the **OK button**.

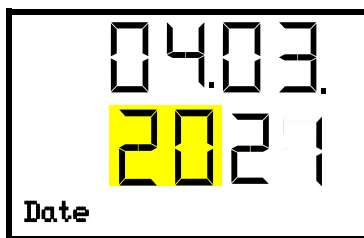

Setting the date: year  
The left two digits are flashing. Enter the first two digits of the current year with the **arrow buttons**.  
Confirm the entry with the **OK button**.



Setting the date: year  
The right two digits are flashing. Enter the last two digits of the current year with the **arrow buttons**.  
Confirm the entry with the **OK button**.

With the **arrow-down button** you can now change to setting the current time.

With the **Back button** you can go back to the "Chamber" submenu and, repeatedly pressing it, to **Normal display**.

## 12.4 Setting the current time

Required access level: "Admin". Following start-up of the chamber (chap. 6), it is "User".

Path: **Normal display** ▾ ▾ ▾ ▾ ▾ **Settings**  **Chamber**  ▾ **Time**

Press the **OK button** to enable the setting.

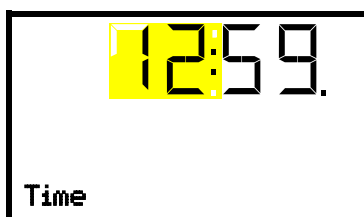

Setting the time: hours  
The current setting flashes. Enter the current hour with the **arrow buttons**.  
Confirm the entry with the **OK button**.



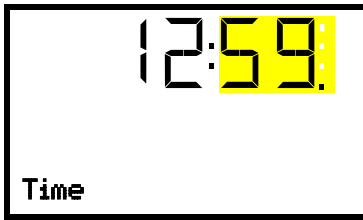

Setting the time: minutes  
The current setting flashes. Enter the current minutes with the **arrow buttons**.  
Confirm the entry with the **OK button**.

With the **Back button** you can go back to the “**Chamber**” submenu and, repeatedly pressing it, to **Normal display**.

## 12.5 Function “Language selection at restart”

If the function “Language selection at restart” is activated, menu language, date, time, and temperature unit are checked with every startup of the chamber. At this occasion it is also possible to modify them with “User” access level.

Required access level: “Admin”.

Path: **Normal display**      **Settings**  **Chamber**     **Language selection at re-start**

Press the **OK button** to enable the setting.



Function “Language selection at restart”  
The current setting flashes. Use the **arrow buttons** to select between ON and OFF.  
Confirm the setting with the **OK button**.











With the **arrow-down button** you can now change to the next parameter (chamber address).

With the **Back button** you can go back to the “**Chamber**” submenu and, repeatedly pressing it, to **Normal display**.

## 12.6 Setting the chamber address

This setting is required for the communication with the BINDER APT-COM™ 4 Multi Management Software. The chamber address settings in the chamber controller and in the software must be identical.

Required access level: “Admin”.

Path: **Normal display**      **Settings**  **Chamber**       **Chamber address**

Press the **OK button** to enable the setting.



Setting the chamber address  
The current setting flashes. Enter the desired address with the **arrow buttons**. Setting range: 1 up to 254  
Confirm the entry with the **OK button**.

With the **arrow-down button** you can now change to the next parameter (display brightness).

With the **Back button** you can go back to the “**Chamber**” submenu and, repeatedly pressing it, to **Normal display**.

## 12.7 Display brightness

Required access level: "Admin".

Path: **Normal display** ▾ ▾ ▾ ▾ ▾ **Settings**  **Chamber**  ▾ ▾ ▾ ▾ ▾ **Brightness**

Press the **OK button** to enable the setting.



Setting the display brightness

The current setting flashes. Enter the desired value with the **arrow buttons**. Setting range: 10% up to 100%

Confirm the entry with the **OK button**.

With the **arrow-down button** you can now change to the next parameter (audible alarm, chap. 14.2).

With the **Back button** you can go back to the "**Chamber**" submenu and, repeatedly pressing it, to **Normal display**.

## 13. Tolerance range settings

In this menu you can define the deviation between the actual value and setpoint, which that shall cause a tolerance range alarm. The entered value defines the limit of permitted deviations from the set-point (exceeding and falling below). Reaching this limit triggers tolerance alarm.

In addition, you can specify a delay time for this alarm.

If the actual value is outside the tolerance range, after the configured alarm delay time the alarm message "Temperature range" is displayed in Normal display (chap. 14.1). If the alarm buzzer is activated (chap. 14.2) there is an audible alert.

This function only activates after the set-point has been reached once.

Required access level: "Admin".

### 13.1 Setting the delay time for tolerance range alarm

Path: **Normal display** ▾ ▾ ▾ ▾ ▾ **Settings**  ▾ ▾ ▾ **Various**  **Range alarm delay (min)**

Press the **OK button** to enable the setting.



Setting the tolerance range alarm delay.





The current setting flashes. Use the **arrow buttons** to enter the desired time after which the range alarm shall be triggered. Entry range: 1 up to 300 minutes. Factory setting: 60 minutes.

Confirm the entry with the **OK button**.

With the **arrow-down button** you can now change to the temperature tolerance range setting.

With the **Back button** you can go back to the "**Various**" submenu and, repeatedly pressing it, to **Normal display**.

## 13.2 Setting the temperature tolerance range

Path: **Normal display**      **Settings**     **Various**   **Temperature range**

Press the **OK button** to enable the setting.

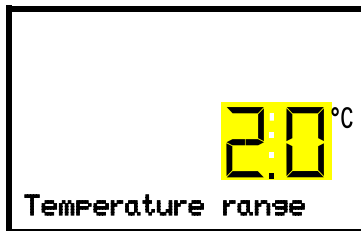

Setting the temperature tolerance range  
The current setting flashes. Enter the desired temperature range with the **arrow buttons**. Entry range: 1.0 °C up to 10.0 °C  
Confirm the entry with the **OK button**.

With the **arrow-up button** you can go back to the tolerance range alarm delay setting.

With the **arrow-down button** you can now change to the setting of the anti-condensation protection (chap. 21).

With the **Back button** you can go back to the “**Various**” submenu and, repeatedly pressing it, to **Normal display**.

## 14. Alarm functions

### 14.1 Alarm messages

In the event of equipment failures, when the temperature deviate from the set tolerance range limits, and with activated self-test function, optical and possibly acoustic alarm messages are given out via the controller.



In Normal display a text message indicates the alarm cause. The “collective alarm” icon flashes. If the audible arm is activated, the buzzer sounds.

Press the **OK button** to confirm the alarm and mute the buzzer. If the alarm cause is still valid, the “collective alarm” icon is lit.

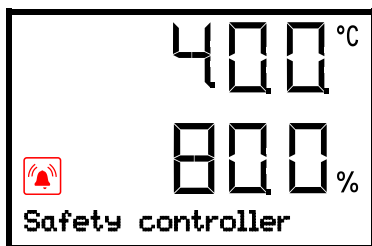

Alarm indication (example: safety controller alarm)

#### Alarm messages overview:

Condition	Alarm message	Start after condition occurred
The current actual temperature value is outside the tolerance range (chap. 13)	“Temperature range”	after configurable time
Exceeded setpoint of the safety controller class 3.1	“Safety controller”	immediately
Temperature sensor defective	e.g. “- - - -” “or” “<-<-<” or “>->->”	immediately
Safety controller temperature sensor defective	Safety controller sensor	immediately
Heating/cooling system defective	“Peltier module”	immediately
Heating/cooling system defective (anti-condensation protection)	“Anti-condensation”	immediately

Press the **OK button** to confirm the alarm.

- Confirmation while the state of alarm persists: Only the buzzer is muted. The visual alarm message continues to be displayed until the alarm condition is removed. Then it is reset automatically.
- Confirmation after the alarm has ended: The buzzer and the visual alarm message are reset together.

## 14.2 Activating / deactivating the audible alarm (alarm buzzer)

Path: **Normal display**      **Settings**  **Chamber**         **Audible alarm**

Press the **OK button** to enable the setting.

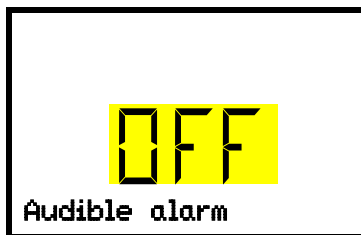

Setting the audible alarm.

The current setting flashes. Use the **arrow buttons** to select between ON and OFF.

Confirm the setting with the **OK button**.

With the **Back button** you can go back to the “**Chamber**” submenu and, repeatedly pressing it, to **Normal display**.

## 15. Program start / stop function

You can start and stop time or week programs at the RD4 controller. The programming itself has to be done using the APT-COM™ 4 Multi Management Software from BINDER (chap. 22.1). There you can create the programs and transfer them to the chamber controller.

Required access level: “User”.

### 15.1 Start time program

Path: **Normal display**   **Programs**  **Time program**

Press the **OK button** to enter the program start submenu.

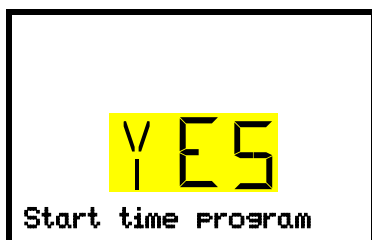

“Start time program” submenu

The current setting flashes. Select with the **arrow buttons** between YES (start time program) and NO (do not start time program).

To start the time program, select “YES” and press the **OK button** to confirm.

With the **Back button** you can go back to the “**Programs**” submenu and, repeatedly pressing it, to **Normal display**.

After selecting “NO”: The controller changes back to Normal display.

After selecting “YES”: The time program starts, the controller displays the information “Program started”. Press the **OK button**. The controller changes to Normal display. The information “Time program active” is displayed alternately with “Temperature”.

## 15.2 Start week program

Path: **Normal display**   **Programs**   **Week program**

Press the **OK button** to enter the program start submenu.

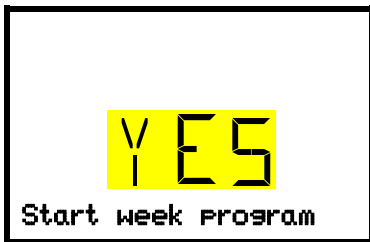

“Start week program” submenu

The current setting flashes. Select with the **arrow buttons** between YES (start week program) and NO (do not start week program).

To start the week program, select “YES” and press the **OK button** to confirm.

With the **Back button** you can go back to the “**Programs**” submenu and, repeatedly pressing it, to **Normal display**.

After selecting “NO”: The controller changes back to Normal display.

After selecting “YES”: The week program starts, the controller displays the information “Program started”. Press the **OK button**. The controller changes to Normal display. The information “Week program active” is displayed alternately with “Temperature”.

## 15.3 Stop program

Path: **Normal display**   **Programs**   **Stop program**

Press the **OK button** to activate the settings.

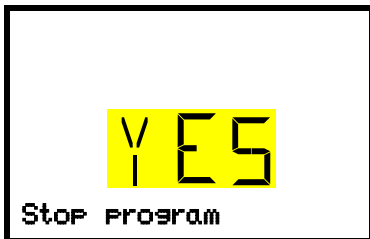

“Stop program” submenu

The current setting flashes. Select with the **arrow buttons** between YES (stop program) and NO (do not stop program).

To stop the week program, select “YES” and press the **OK button** to confirm.

With the **Back button** you can go back to the “**Programs**” submenu and, repeatedly pressing it, to **Normal display**.

After selecting “NO”: The controller changes back to Normal display. The program continues.

After selecting “YES”: The program stops. Press the **OK button**. The controller changes to Normal display.

## 16. Ethernet network settings

The settings of this submenu are used for networking chambers with an Ethernet interface, e.g. to connect them with BINDER’s APT-COM™ 4 Multi Management Software (option, chap. 22.1).

### 16.1 Showing the network settings

Required access level: “User”.

The “Ethernet” submenu offers to subsequently or individually access the following information:

- MAC address
- IP address
- Subnet mask
- Standard gateway
- DNS server address
- DNS chamber name

### 16.1.1 Showing the chamber's MAC address

Path: **Normal display** ▾ ▾ ▾ **Chamber info**  ▾ ▾ ▾ ▾ ▾ ▾ ▾ **Ethernet**  **MAC address**

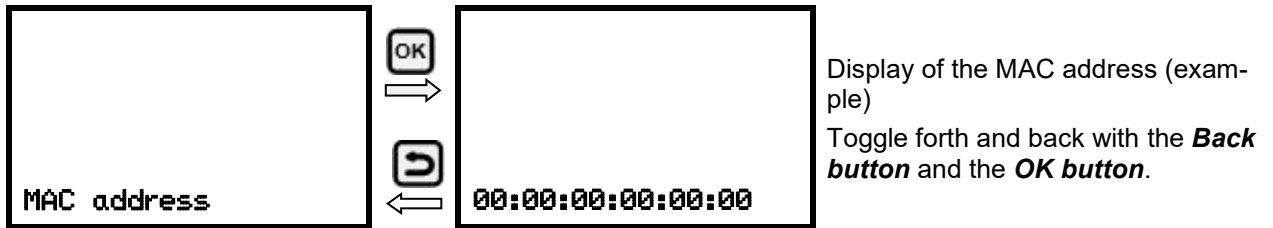

With the **arrow-down button** you can now change to the next parameter (IP address).

With the **Back button** you can go back to the “**Ethernet**” submenu and, repeatedly pressing it, to **Normal display**.

### 16.1.2 Showing the IP address

Path: **Normal display** ▾ ▾ ▾ **Chamber info**  ▾ ▾ ▾ ▾ ▾ ▾ ▾ **Ethernet**  **IP address**



With the **arrow-down button** you can now change to the next parameter (subnet mask).

With the **Back button** you can go back to the “**Ethernet**” submenu and, repeatedly pressing it, to **Normal display**.

### 16.1.3 Showing the subnet mask

Path: **Normal display** ▾ ▾ ▾ **Chamber info**  ▾ ▾ ▾ ▾ ▾ ▾ ▾ **Ethernet**  **Subnet mask**



With the **arrow-down button** you can now change to the next parameter (standard gateway).

With the **Back button** you can go back to the “**Ethernet**” submenu and, repeatedly pressing it, to **Normal display**.

### 16.1.4 Showing the standard gateway

Path: **Normal display** ▾ ▾ ▾ **Chamber info**  ▾ ▾ ▾ ▾ ▾ ▾ ▾ **Ethernet**  ▾ ▾ ▾ ▾  
**Standard gateway**

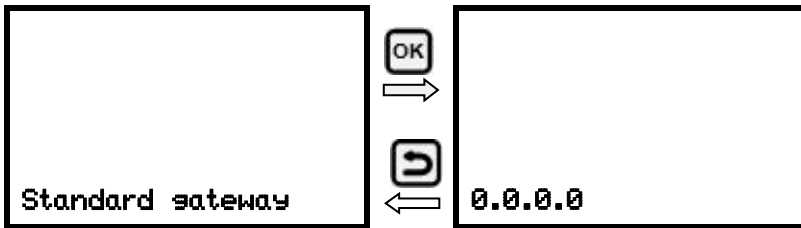

Display of the standard gateway (example)  
 Toggle forth and back with the **Back button** and the **OK button**.

With the **arrow-down button** you can now change to the next parameter (DNS server address).

With the **Back button** you can go back to the “**Ethernet**” submenu and, repeatedly pressing it, to **Normal display**.

### 16.1.5 Showing the DNS server address

Path: **Normal display** ▾ ▾ ▾ **Chamber info**  ▾ ▾ ▾ ▾ ▾ ▾ ▾ **Ethernet**  ▾ ▾ ▾ ▾ ▾  
**DNS server address**

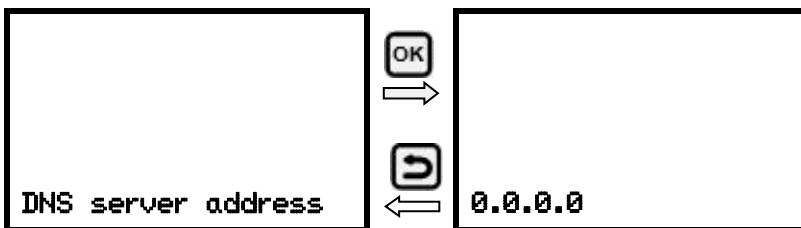

Display of the DNS server address (example)  
 Toggle forth and back with the **Back button** and the **OK button**.

With the **arrow-down button** you can now change to the next parameter (DNS chamber name).

With the **Back button** you can go back to the “**Ethernet**” submenu and, repeatedly pressing it, to **Normal display**.

### 16.1.6 Showing the DNS chamber name

Path: **Normal display** ▾ ▾ ▾ **Chamber info**  ▾ ▾ ▾ ▾ ▾ ▾ ▾ **Ethernet**  ▾ ▾ ▾ ▾ ▾ ▾  
**DNS chamber name**

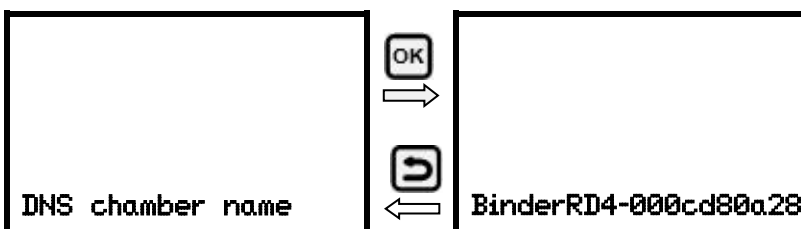

Display of the DNS chamber name (example)  
 Toggle forth and back with the **Back button** and the **OK button**.

With the **Back button** you can go back to the “**Ethernet**” submenu and, repeatedly pressing it, to **Normal display**.

## 16.2 Changing the configuration of the network settings

Required access level: "Admin".

The "Ethernet" submenu offers to subsequently or individually access the following settings:

- Selecting the type of assignment (automatic or manual) of the IP address, chap. 16.2.1

If automatic IP address assignment has been selected:

- Selecting the type of assignment (automatic or manual) of the DNS server address, chap. 16.2.2

If manual IP address assignment has been selected:

- Assigning the IP address, chap. 16.2.3
- Assigning the subnet mask, chap. 16.2.4
- Assigning the standard gateway, chap. 16.2.5

If manual IP address assignment or manual DNS server address assignment has been selected:

- Assigning the DNS server address, chap. 16.2.6

### 16.2.1 Selecting the type of IP address assignment (automatic / manual)

Path: **Normal display** ▾ ▾ ▾ ▾ **Settings**  **Ethernet**  **IP address assignment**

Press the **OK button** to enable the setting



Selection of the type of assignment of the IP address.

The current setting flashes. Use the **arrow buttons** to select between AUTO (automatic) and MANU (manual).

Confirm the setting with the **OK button**.

With the **arrow-down button** you can now change to the next parameter.

- If manual IP address assignment has been selected: assign the IP address (chap. 16.2.3)
- If automatic IP address assignment has been selected: select the type of assignment of the DNS server address (chap. 16.2.2).

With the **Back button** you can go back to the "Ethernet" submenu and, repeatedly pressing it, to **Normal display**.

### 16.2.2 Selecting the type of assignment of the DNS server address (automatic / manual)

Access to this function is possible only if automatic IP address assignment has been selected (chap. 16.2.1).

Path: **Normal display** ▾ ▾ ▾ ▾ **Settings**  **Ethernet**  **DNS server**

Press the **OK button** to enable the setting.

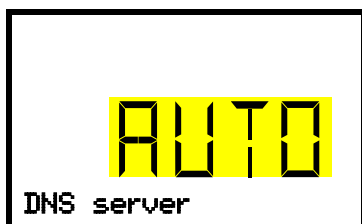

Selection of the type of assignment of the DNS server address.

The current setting flashes. Use the **arrow buttons** to select between AUTO (automatic) and MANU (manual).

Confirm the setting with the **OK button**.

If manual assignment of the DNS server address has been selected, you can now change with the **arrow-down button** to assign the DNS server address (chap. 16.2.6).



With the **Back button** you can go back to the “Ethernet” submenu and, repeatedly pressing it, to **Normal display**.

### 16.2.3 Assigning the IP address

Access to this function is possible only if manual IP address assignment has been selected (chap. 16.2.1)

Path: **Normal display**     **Settings**   **Ethernet**    **IP address**

Press the **OK button** to enable the setting.

The IP address entry is done in four steps, corresponding to the number sections: (1).(2).(3).(4)

Principle of entry:

- Use the **OK button** to select the desired section of the IP address 1/4, 2/4, 3/4, 4/4 in the upper display line
- Use the **Arrow buttons** to enter the value for the selected section of the IP address



IP address assignment (sample values).

The first section of the IP address is shown. Enter the desired value with the **arrow buttons**.

Use the **OK button** to confirm the entry and proceed to the second section of the IP address.

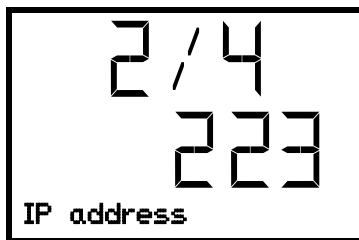

IP address assignment (sample values).

The second section of the IP address is shown. Enter the desired value with the **arrow buttons**.

Use the **OK button** to confirm the entry and proceed to the third section of the IP address.

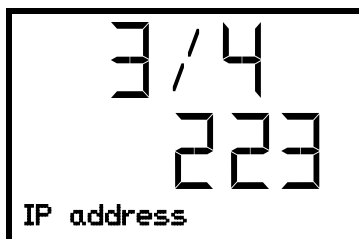

IP address assignment (sample values).

The third section of the IP address is shown. Enter the desired value with the **arrow buttons**.

Use the **OK button** to confirm the entry and proceed to the last section of the IP address.



IP address assignment (sample values).

The fourth section of the IP address is shown. Enter the desired value with the **arrow buttons**.

Confirm the setting with the **OK button**.

With the **arrow-down button** you can now change to enter the subnet mask.

With the **Back button** you can go back to the “Ethernet” submenu and, repeatedly pressing it, to **Normal display**.

#### 16.2.4 Setting the subnet mask

Access to this function is possible only if manual IP address assignment has been selected (chap. 16.2.1)

Path: **Normal display**     **Settings**   **Ethernet**     **Subnet mask**

Press the **OK button** to enable the setting.

The subnet mask entry is done in four steps, corresponding to the number sections: (1).(2).(3).(4)

Principle of entry:

- Use the **OK button** to select the desired section of the subnet mask 1/4, 2/4, 3/4, 4/4 in the upper display line
- Use the **Arrow buttons** to enter the value for the selected section of the subnet mask

For details please refer to the description of the similar procedure in chap. 16.2.3 "Assigning the IP address".

With the **arrow-down button** you can now change to the enter the standard gateway.

With the **Back button** you can go back to the "**Ethernet**" submenu and, repeatedly pressing it, to **Normal display**.

#### 16.2.5 Setting the standard gateway

Access to this function is possible only if manual IP address assignment has been selected (chap. 16.2.1)

Path: **Normal display**     **Settings**   **Ethernet**     **Standard gateway**

Press the **OK button** to enable the setting.

The standard gateway entry is done in four steps, corresponding to the number sections: (1).(2).(3).(4)

Principle of entry:

- Use the **OK button** to select the desired section of the standard gateway 1/4, 2/4, 3/4, 4/4 in the upper display line
- Use the **Arrow buttons** to enter the value for the selected section of the standard gateway
- For details please refer to the description of the similar procedure in chap. 16.2.3 "Assigning the IP address".

With the **arrow-down button** you can now change to the assign the DNS server address.

With the **Back button** you can go back to the "**Ethernet**" submenu and, repeatedly pressing it, to **Normal display**.

#### 16.2.6 Assigning the DNS server address

Access to this function is possible if manual IP address assignment (chap. 16.2.1) or manual DNS server address assignment (chap. 16.2.2) has been selected.

With manual IP address assignment:

Path: **Normal display**     **Settings**   **Ethernet**     **DNS server address**

With manual DNS server address assignment:

Path: **Normal display**     **Settings**   **Ethernet**    **DNS server address**

Press the **OK button** to enable the setting.

The DNS server address entry is done in four steps, corresponding to the number sections: (1).(2).(3).(4)

Principle of entry:

- Use the **OK button** to select the desired section of the DNS server address 1/4, 2/4, 3/4, 4/4 in the upper display line
- Use the **Arrow buttons** to enter the value for the selected section of the DNS server address
- For details please refer to the description of the similar procedure in chap. 16.2.3 “Assigning the IP address”.

With the **Back button** you can go back to the “Ethernet” submenu and, repeatedly pressing it, to **Normal display**.

## 17. Data recorder

An internal data recorder saves chamber data and events in three data sets.

With the export function “Export recorder data” (chap. 18.3) you can save the three data sets via the USB interface to USB stick. They are issued in the selected language as a spreadsheet with the file extension “.csv” and can be further processed in the desired program. The data is unencrypted. Always the entire data memory is read out.

### 17.1 Recorded data

All data is given out in tabular form. The headlines of the values “number”, “date”, and “time” are given out in the selected language, all other information in English.

- **Chamber data for the user “DL1”**

Tabular representation of the actual temperature values together with the date and time, according to the set storage rate (chap. 17.3). Temperature values are always given out in °C.

- **Chamber data for BINDER Service “DL2”**

This data is intended for use by BINDER Service. It also contains information from the self-test function. The storage rate is fix (1 minute). Temperature values are always given out in °C.

- **Event list**

Messages regarding the controller and data memory as well as the alarm messages together with the date and time:

- Firmware update done
- “New config (USB)”: New configuration uploaded via USB
- “Data recorder cleared”: Data recorder and event list deleted via setup program
- Other event messages according to existing alarms
- The moment of switching the alarm state on and off is indicated under “On/Off”.

## 17.2 Storage capacity

The storage capacity of the data recorder depends on the number of entries.

- DL1 = 110.000 entries (equaling 76 days with a storage rate of 1 minute, setting see chap. 17.3)
- DL2 = 27.000 entries (equaling 18 days with a fix storage rate of 1 minute)
- Event list: 200 events

The shorter the set storage rate, the closer are the stored measuring points, the more precise, but also shorter is the documented period.

Once the storage capacity of the data recorder is reached, overwriting of the oldest values begins

## 17.3 Setting the storage rate for the “DL1” recorder data

Required access level: “Admin”.

Path: **Normal display**     **Settings**    **Data recorder**  **Storage interval**

Press the **OK button** to enable the setting.

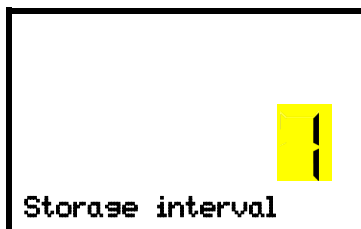

Function “Storage interval”.

The current setting flashes. Use the **arrow buttons** to enter the desired storage interval. Setting range: 1 minute to 60 minutes.

Press the **OK button** to confirm the setting.

With the **Back button** you can go back to the “**Data recorder**” submenu and, repeatedly pressing it, to **Normal display**.

## 17.4 Deleting the data recorder

When importing a configuration via USB stick and when loading a new firmware version by BINDER service, the entire data memory is deleted.

BINDER service can also install the configuration by means of a setup program without deleting the data.

Regardless of this, BINDER Service can delete the data via a setup program.

Loading a new configuration via USB-Stick leads to deleting the data recorder.

	NOTICE
	<p><b>Danger of information loss when loading a new configuration.</b>  <b>Information loss.</b></p> <p>➤ Backup data prior to loading a new configuration.</p>

## 18. USB menu: Data transfer via USB interface

A USB interface for data transfer via USB stick is located in the instrument box (the second micro USB interface is only used by the manufacturer).

The controller offers an import function and three export functions through the USB interface:

### Import function (chap. 18.2):

- Configuration data in file "KONF380.set"

### Export functions (chap. 18.3):

- Configuration data in file "KONF380.set"
- Recorder data
  - DL1 (chamber data for the user): "DL1\_[MAC address of the chamber].csv"
  - DL2 (chamber data for BINDER Service): "DL2\_[MAC address of the chamber].csv"
  - Event list: "EvList\_[MAC address of the chamber].csv"

For detailed information on the file content see chap. 17.1.

- Service data

The "Service" folder is created on the USB stick and can be sent to BINDER Service. In addition to the configuration and recorder data, it contains further service-relevant information.

### 18.1 Connecting the USB stick

Connect the USB stick to the interface located in the triangular instrument panel.



Connect only USB sticks to the USB interface.  
The USB stick must be formatted with FAT32 and have at least 8GB of memory.

After inserting the USB stick, the initial function "Import configuration" is displayed.

As long as the USB stick is connected, only the functions for data transfer are available. Other controller functions are only available after removing the USB stick.

### 18.2 Import function

Required access level: "Admin".



Function "Import configuration".

To import configuration data from the USB stick, press the **OK button**.

With the **arrow-down button** you can now change to the setting of the "Export configuration" function.

### 18.3 Export functions

Required access level: any user



Function "Export configuration".

To write the configuration data from the controller to the USB stick, press the **OK button**.

With the **arrow-down button** you can now change to the next function.



Function "Export recorder data".

To write the recorder data from the controller to the USB stick, press the **OK button**.

With the **arrow-down button** you can now change to the next function.



Function "Export service data".

To write the chamber data from the controller to the USB stick, press the **OK button**.

### 18.4 Ongoing data transfer

A moving arrow symbol indicates the progress of the data transfer.

Example:



Data recording is running.

Attention! Danger of data loss! Do not disconnect the USB stick from the device during ongoing data transfer!

After successful transfer, the controller shows again the initial function "Import configuration".

### 18.5 Error during data transmission

In the event of an error, the message ERR (error) is displayed.



Read error (example).

## 18.6 Removing the USB stick

Logging off the USB stick is not possible / required.

Be sure that no data recording is running (chap. 18.4).

After removing the USB stick, the controller is back in the same menu as before when connecting the USB stick.

## 19. Self-test function

The self-test function enables an automated check of the proper chamber functioning as well as a targeted and reliable fault analysis. In this case, the chamber successively undergoes various defined operating states, which serves to determine reproducible characteristic values. These characteristic values provide information on the performance and precision of the individual functional systems of the chamber (e.g., heating, refrigeration) of the chamber.

The results of the self-test are stored in the service recorder of the controller. You can export them using the controller's USB interface and send them to BINDER Service (use function "Export recorder data" to USB stick, chap. 18). BINDER Service will evaluate the data using an analyzing tool.

	<p>In order to allow an optimum comparison of the determined characteristic values with the reference characteristic values, the ambient temperature should be in the range of +22 °C +/- 3 °C / 71.6 °F +/- 5.4 °F.</p> <p>The chamber shall be unloaded (empty with standard equipment).</p>
---	--

### 19.1 Activating the self-test function

Required access level: "Admin".

Path: **Normal display** ▾ ▾ ▾ ▾ **Settings**  ▾ ▾ ▾ **Variou**  ▾ ▾ ▾ ▾ ▾ ▾ ▾ **Self-test**

Press the **OK button** to enable the settings.

Following, you can choose between the following settings:

- "0" (function off)
- "1" (self-test; duration: 12-18 hours)



#### Setting the self-test function

The current setting flashes. Use the **arrow buttons** to select the setting "1" to activate the self-test function.

Confirm the setting with the **OK button**.

Press the **Back button** several times to go back to **Normal display**.

In Normal display the activated Self-test function is shown. The "Collective alarm" icon is lit. The entered setpoint values are inactive, the stored test program is running. With activated audible signal: The buzzer sounds. Press the **OK button** to mute the buzzer.

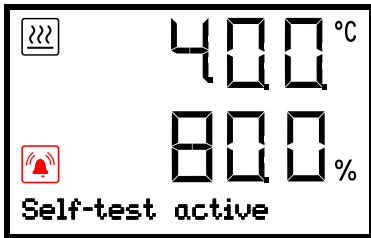

Display showing the running self-test in Normal display (example values)



Do not open and do not turn off the chamber while self-test is running. After an interruption of the voltage supply, the self-test restarts.

If desired, you can cancel an ongoing self-test by deactivating the self-test function in the controller menu (chap. 19.2).

When the complete self-test has finished, the message “Self-test completed” appears. The setpoint values become active again



Display showing the completed self-test in Normal display (example values)

To delete the alarm message then deactivate the self-test function (chap. 19.2).

## 19.2 Deactivating the self-test mode

You can deactivate the self-test mode via the controller menu:

- cancel the running self-test prematurely
- to delete the alarm message after completing the entire self-test

The procedure is similar to activating the self-test function.

Required access level: “Admin”.

Path: **Normal display** ▾ ▾ ▾ ▾ **Settings**  ▾ ▾ ▾ **Various**  ▾ ▾ ▾ ▾ ▾ ▾ ▾ **Self-test**

Press the **OK button** to enable the settings.



Configuring the self-test function

The current setting flashes. To deactivate the self-test function, select the setting “0” with the **Arrow buttons**.

Confirm the setting with the **OK button**.

Press the **Back button** several times to go back to **Normal display**.



## 20. Defrosting at refrigerating operation

BINDER cooling incubators are very diffusion-proof. In favor of the high temperature accuracy, no automatic cyclical defrosting device is used. At very low temperatures the moisture in the air can condense on the heat sinks leading to icing.



Always close the door properly.

**Operation with temperature set-points above +5 °C / 41 °F at an ambient temperature of 25 °C / 77 °F:**

The air defrosts the ice cover automatically. Defrosting is continually performed.

**Operation with temperature set-points below +5 °C / 41 °F:**

Icing on the heat sinks is possible. Defrost the chamber manually.



With temperature set-points below +5 °C / 41 °F, regularly defrost the chamber manually:

- Set the temperature to 40 °C / 104 °F.
- Let the chamber operate for about 30 minutes with the door closed.



Too much ice on the heat sinks is noticeable by reduced refrigerating performance.

## 21. Anti-condensation protection

Depending on the load, for example with a large number of Petri dishes, a lot of moisture can be released in the interior of the chamber. One of the Peltier modules ensures that the humidity is limited. With the “Anti-condensation protection” function, you can adjust the degree of dehumidification in order to reduce condensation.

Path: **Normal display**      **Settings**     **Various**    **Anti-condensation**

Press the **OK button** to enable the setting.

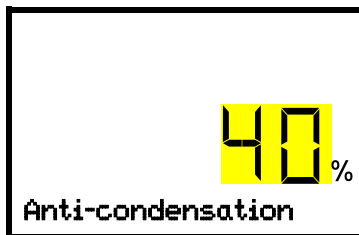

Setting the anti-condensation protection

The current setting flashes. Enter the desired intensity of the anti-condensation protection with the **arrow buttons**. Entry range: 0 % up to 100 %.

Confirm the entry with the **OK button**.

With the **arrow-up button** you can go back to the temperature tolerance range setting (chap. 13.2).

With the **Back button** you can go back to the “**Various**” submenu and, repeatedly pressing it, to **Normal display**.

### Information on the setting

Factory setting is 40% intensity. This setting is suitable for most applications.

If a higher level of humidity in the interior leads to condensation, the intensity of the condensation protection can be increased, thereby preventing condensation on the door and in the interior. However, this also slightly increases the energy consumption.

The intensity can be reduced for applications with low humidity introduction, which also lowers energy consumption. The most energy-saving setting of 0% is suitable for applications without humidity introduction.

## 22. Options

### 22.1 APT-COM™ 4 Multi Management Software (option)

The chamber is regularly equipped with an Ethernet interface (6) that can connect the BINDER APT-COM™ 4 Multi Management Software. The MAC Address is indicated in the "Ethernet" controller menu (chap. 16.1.1). The actual temperature values are given at adjustable intervals. Programming can be performed graphically via PC. Up to 100 chambers can be cross-linked. For further information please refer to the APT-COM™ 4 operating manual.

### 22.2 Data logger kit (option)

BINDER Data Logger Kit offers an independent long-term measuring system for temperature, available for different temperature ranges.

The BINDER Data Logger is equipped with a keyboard and a large LCD display, alarm functions and a real-time function. Measurement data are recorded in the Data Logger and can be read out after the measurement via the RS232 interface of the Data Logger. It offers a programmable measuring interval and permits storing up to 64000 measuring values. Reading out is done with the Data Logger evaluation software. You can give out a combined alarm and status protocol directly to a serial printer.





**Data Logger Kit T 220:** Sensor for chamber temperature: Temperature range -90 °C / 194 °F up to +220 °C / 428 °F.

	<p>For detailed information on installation and operation of the BINDER Data Logger, please refer to the mounting instructions Art. No. 7001-0204 and to the original user manual of the manufacturer, supplied with the data logger.</p>
--	---

## 23. Cleaning and decontamination

Clean the chamber after each use in order to prevent potential corrosion damage by ingredients of the loading material.

Prior to renewed startup, allow the chamber to completely dry after all cleaning and decontamination measures.

  	<div style="background-color: red; color: white; padding: 5px; text-align: center;">  <b>DANGER</b> </div> <p><b>Electrical hazard by water entering the chamber.</b>  <b>Deadly electric shock.</b></p> <ul style="list-style-type: none"> <li>⊘ Do NOT spill water or cleaning agents over the inner and outer chamber surfaces.</li> <li>⊘ Do NOT put ANY cleaning aids (cloth or brush) into slots or openings on the chamber.</li> <li>➤ Before cleaning, turn off the chamber at the main power switch and disconnect the power plug. Let the chamber cool down to ambient temperature.</li> <li>➤ Completely dry the chamber before turning it on again.</li> </ul>
---	--

## 23.1 Cleaning

Disconnect the chamber from the power supply before cleaning. Pull the power plug.

	The interior of the chamber must be kept clean. Thoroughly remove any residues of test material.
---	--

Wipe the surfaces with a moistened towel. In addition, you can use the following cleaning agents:

Exterior surfaces inner chamber racks door gaskets	Standard commercial cleaning detergents free from acid or halides. Alcohol-based solutions. We recommend using the neutral cleaning agent Art. No. 1002-0016.
Instrument panel	Standard commercial cleaning detergents free from acid or halides. We recommend using the neutral cleaning agent Art. No. 1002-0016.
Zinc coated hinge parts rear chamber wall	Standard commercial cleaning detergents free from acid or halides. Do NOT use a neutral cleaning agent on zinc coated surfaces.

Do not use cleaning agents that may cause a hazard due to reaction with components of the device or the charging material. If there is doubt regarding the suitability of cleaning products, please contact BINDER service.

	We recommend using the neutral cleaning agent Art. No. 1002-0016 for a thorough cleaning. Any corrosive damage that may arise following use of other cleaning agents is excluded from liability by BINDER GmbH. Any corrosive damage caused by a lack of cleaning, is excluded from liability by BINDER GmbH.
---	---

	<b>NOTICE</b>
	<p><b>Danger of corrosion by using unsuitable cleaners.</b> <b>Damage to the chamber.</b></p> <ul style="list-style-type: none"> <li>∅ Do NOT use acidic or chlorine cleaning detergents.</li> <li>∅ Do NOT use a neutral cleaning agent on other kind of surfaces e.g., the zinc coated hinge parts or the rear chamber wall.</li> </ul>

	For surface protection, perform cleaning as quickly as possible. After cleaning completely remove cleaning agents from the surfaces with a moistened towel. Let the chamber dry.
---	--



	Soapsuds may contain chlorides and must therefore NOT be used for cleaning.
---	---

	With every cleaning method, always use adequate personal safety controls.
---	---

Following cleaning, leave the chamber door open or remove the access port plugs.

	The neutral cleaning agent may cause health problems in contact with skin and if ingested. Follow the operating instructions and safety hints labeled on the bottle of the neutral cleaning agent.
---	--

Recommended precautions: To protect the eyes use sealed protective goggles. Wear gloves. Suitable protective gloves in full contact with media: butyl or nitrile rubber, penetration time >480 minutes.

	 <b>CAUTION</b>
	<p><b>Danger of chemical burns through contact with skin or ingestion of the neutral cleaning agent.</b></p> <p><b>Skin and eye damage. Environmental damage.</b></p> <ul style="list-style-type: none"> <li>Ø Do not ingest the neutral cleaning agent. Keep it away from food and beverages.</li> <li>Ø Do NOT empty the neutral cleaning agent into drains.</li> <li>➤ Wear protective gloves and goggles.</li> <li>➤ Avoid skin contact with the neutral cleaning agent.</li> </ul>

## 23.2 Decontamination / chemical disinfection

The operator must ensure that proper decontamination is performed in case a contamination of the chamber by hazardous substances has occurred.

Disconnect the chamber from the power supply prior to chemical decontamination. Pull the power plug.

Do not use decontamination agents that may cause a hazard due to reaction with components of the device or the charging material. If there is doubt regarding the suitability of cleaning products, please contact BINDER service.

You can use the following disinfectants:

Inner chamber	Standard commercial surface disinfectants free from acid or halides. Alcohol-based solutions. We recommend using the disinfectant spray Art. No. 1002-0022.
---------------	---

	For chemical disinfection, we recommend using the disinfectant spray Art. No. 1002-0022. Any corrosive damage that may arise following use of other disinfectants is excluded from liability by BINDER GmbH.
---	---



	With every decontamination method, always use adequate personal safety controls.
---	--

In case of contamination of the interior by biologically or chemically hazardous material, there are two possible procedures depending on the type of contamination and charging material:

1. Spray the inner chamber with an appropriate disinfectant.  
Before start-up, the chamber must be absolutely dry and ventilated, as explosive gases may form during the decontamination process.
2. If necessary, have strongly contaminated inner chamber parts removed by an engineer for cleaning, or have them exchanged. Sterilize the inner chamber parts in a sterilizer or autoclave.

	In case of eye contact, the disinfectant spray may cause eye damage due to chemical burns. Follow the operating instructions and safety hints labeled on the bottle of the disinfectant spray.
---	--

Recommended precautions: To protect the eyes use sealed protective goggles.

	<div style="background-color: yellow; text-align: center; padding: 5px;"> <b>CAUTION</b></div> <p><b>Danger of chemical burns through eye contact with the disinfectant spray.</b></p> <p><b>Eye damage. Environmental damage</b></p> <ul style="list-style-type: none"> <li>∅ Do NOT empty the disinfectant into drains.</li> <li>➤ Wear protective goggles.</li> </ul>
	<p>After using the disinfectant spray, allow the chamber to dry thoroughly, and aerate it sufficiently.</p>

## 24. Maintenance and service, troubleshooting, repair, testing

### 24.1 General information, personnel qualification

- **Maintenance**

See chap. 24.2

- **Simple troubleshooting**

Chap. 24.4 describes troubleshooting by operating personnel. It does not require technical intervention into the chamber, nor disassembly of chamber parts.

For personnel requirements please refer to chap. 1.1.

- **Detailed troubleshooting**

If errors cannot be identified with simple troubleshooting, further troubleshooting must be performed by BINDER Service or by BINDER qualified service partners or technicians, in accordance with the description in the Service Manual.

For personnel requirements please refer to the Service Manual.

- **Repair**

Repair of the chamber can be performed by BINDER Service or by BINDER qualified service partners or technicians, in accordance with the description in the Service Manual.



After maintenance, the chamber must be tested prior to resuming operation.

- **Electrical testing**

To prevent the risk of electrical shock from the electrical equipment of the chamber, an annual repeat inspection as well as a test prior to initial startup and prior to resuming operation after maintenance or repair, are required. This test must meet the requirements of the competent public authorities. We recommend testing under DIN VDE 0701-0702:2008 in accordance with the details in the Service Manual.

For personnel requirements please refer to the Service Manual.

## 24.2 Maintenance intervals, service

 	 <b>DANGER</b>
	<p><b>Electrical hazard during live maintenance work.</b>  <b>Deadly electric shock.</b></p> <ul style="list-style-type: none"> <li>⊘ The chamber must NOT become wet during operation or maintenance works.</li> <li>⊘ Do NOT remove the rear panel of the chamber.</li> <li>➤ Disconnect the chamber before conducting maintenance work. Turn off the main power switch and pull the power plug.</li> <li>➤ Make sure that all maintenance work will be conducted by licensed electricians or experts authorized by BINDER.</li> </ul>

Ensure regular maintenance work is performed at least once a year.

	The warranty becomes void if maintenance work is conducted by non-authorized personnel.
---	---

	Replace the door gasket only when cold. Otherwise, the door gasket may become damaged.
---	--

With an increased amount of dust in the ambient air, clean the Peltier fan grid (by suction or blowing) several times a year.

We recommend taking out a maintenance agreement. Please consult BINDER Service:

BINDER telephone hotline:	+49 (0) 7462 2005 555
BINDER fax hotline:	+49 (0) 7462 2005 93555
BINDER e-mail hotline:	customerservice@binder-world.com
BINDER service hotline USA:	+1 866 885 9794 or +1 631 224 4340 x3 (toll-free in the USA)
BINDER service hotline Asia Pacific:	+852 390 705 04 or +852 390 705 03
BINDER service hotline Russia and CIS	+7 495 988 15 16
BINDER Internet website	<a href="http://www.binder-world.com">http://www.binder-world.com</a>
BINDER address	BINDER GmbH, post office box 102, 78502 Tuttlingen, Germany

International customers, please contact your local BINDER distributor.

## 24.3 Service Reminder

You can display the time until the service due in the controller. Keep the **OK button** pressed down for 5 seconds.

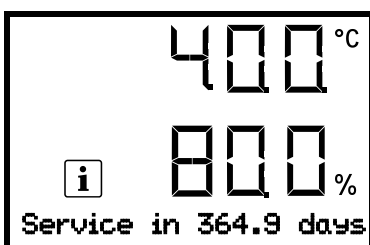

The remaining time in days until maintenance is due is shown in the text field of the controller display.  
 Press the **OK button** to confirm the message.

After the recommended maintenance interval (one year of operation) a message appears on the controller.

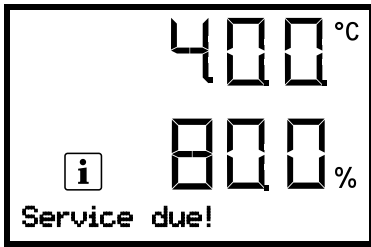

The message "Service due!" is shown in the text field of the controller display.

Press the **OK button** to confirm the message.

After one week of operation, the message reappears.

## 24.4 Simple troubleshooting

Defects and shortcomings can compromise the operational safety of the chamber and can lead to risks and damage to equipment and persons. If there is a technical fault or shortcoming, take the chamber out of operation and inform BINDER Service. If you are not sure whether there is a technical fault, proceed according to the following list. If you cannot clearly identify an error or there is a technical fault, please contact BINDER Service.



Only qualified service personnel authorized by BINDER must perform repair. Repaired chambers must comply with the BINDER quality standards.

Fault description	Possible cause	Required measures
<b>General</b>		
Chamber without function.	No power supply.	Check connection to power supply. Check whether the chamber is turned on at the main power switch.
	Wrong voltage.	Check power supply for correct voltage (chap. 4.1).
	Chamber fuse has responded.	Check chamber fuse and replace it if appropriate. If it responds again, contact BINDER service.
	Controller defective.	Contact BINDER service.
	Nominal temperature exceeded by 10°C due to chamber failure. Over temperature protective device (class 1) responds.	
<b>Heating</b>		
Chamber heating permanently, set-point not maintained.	Controller defective.	Contact BINDER service.
	Controller not well adjusted, or adjustment interval exceeded.	Calibrate and adjust controller.
Chamber doesn't heat up.	Pt 100 sensor defective.	Contact BINDER service.
	Peltier module for heating/refrigeration defective.	
	Semiconductor relay defective	
Chamber doesn't heat up when turned on. Safety controller responds.	Inner chamber temperature has reached the safety controller value. Safety controller set too low.	Acknowledge the alarm on the controller. Check temperature setpoint setting. If appropriate, select suitable safety controller value (chap. 11.2).
	Safety controller (chap. 11.2) defective.	Contact BINDER service.

Fault description	Possible cause	Required measures
<b>Refrigerating performance</b>		
Low or no refrigerating performance.	Ambient temperature above 25 °C / 77 °F (chap.3.4).	Select cooler place of installation.
	Peltier module for heating/refrigeration defective.	Contact BINDER service.
	Too much external heat load.	Reduce heat load.
<b>Condensation</b>		
Icing on the heat sinks.	Set-point was too long below ambient temperature.	Defrost the chamber (chap. 20).
Condensation at the walls of the inner chamber and/or at the door.	Set-point was too long below ambient temperature, icing in the preheating chamber.	Defrost the chamber (chap. 20).
	Humidity introduction. Anti-condensation protection set too low.	Increase the anti-condensation protection intensity (chap. 21).
<b>Controller</b>		
No chamber function (dark display).	Main power switch turned off.	Turn on the main power switch.
Menu functions not available.	Menu functions not available with current authorization level.	Log in with the required higher authorization.
No access to controller	Password incorrect.	Contact BINDER service.
Acknowledging the alarm does not cancel the alarm state.	Cause of alarm persists.	Remove cause of alarm. If the alarm state continues, contact BINDER service.
Alarm message: - - - - or <-<-< or >->->	Sensor rupture between sensor and controller or Pt 100 sensor defective.	Contact BINDER service.
	Short-circuit.	

## 24.5 Sending the chamber back to BINDER GmbH

If you return a BINDER product to us for repair or any other reason, we will only accept the product upon presentation of an **authorization number** (RMA number) that has previously been issued to you. An authorization number will be issued after receiving your complaint either in writing or by telephone **prior** to your sending the BINDER product back to us. The authorization number will be issued following receipt of the information below:

- BINDER product type and serial number
- Date of purchase
- Name and address of the dealer from which you bought the BINDER product
- Exact description of the defect or fault
- Complete address, contact person and availability of that person
- Exact location of the BINDER product in your facility
- A contamination clearance certificate (chap. 28) must be faxed in advance

The authorization number must be applied to the packaging in such a way that it can be easily recognized or be recorded clearly in the delivery documents.



For security reasons we cannot accept a chamber delivery if it does not carry an authorization number.

**Return address:** BINDER GmbH      Gänsäcker 16  
Abteilung Service      78502 Tuttlingen, Germany



## 25. Disposal

### 25.1 Disposal of the transport packing

Packing element	Material	Disposal
Straps to fix packing on pallet	Plastic	Plastic recycling
Wooden transport box (option) with metal screws	Non-wood (compressed match-wood, IPPC standard)	Wood recycling
	Metal	Metal recycling
Pallet with foamed plastic stuffing	Solid wood (IPPC standard)	Wood recycling
	PE foam	Plastic recycling
Transport box with metal clamps	Cardboard	Paper recycling
	Metal	Metal recycling
Top cover	Cardboard	Paper recycling
Edge protection	Styropor® or PE foam	Plastic recycling
Protection of doors and racks	PE foam	Plastic recycling
Bag for operating manual	PE foil	Plastic recycling
Insulating air cushion foil (packing of optional accessories)	PE foil	Plastic recycling

If recycling is not possible, all packing parts can also be disposed of with normal waste.

### 25.2 Decommissioning

- Turn off the chamber at the main power switch (1) and disconnect it from the power supply (pull the power plug).
- Temporal decommissioning: See indications for appropriate storage, chap. 3.3.
- Final decommissioning: Dispose of the chamber as described in chap. 25.3 to 25.5.

### 25.3 Disposal of the chamber in the Federal Republic of Germany

According to Annex I of Directive 2012/19/EU of the European Parliament and of the Council on waste electrical and electronic equipment (WEEE), BINDER devices are classified as “monitoring and control instruments” (category 9) only intended for professional use”. They must not be disposed of at public collecting points.

The chambers bear the symbol for the marking of electrical and electronic equipment manufactured / placed on the market in the EU after 13 August 2005 and be disposed of in separate collection according to Directive 2012/19/EU on waste electrical and electronic equipment (WEEE) and German national law for electrical and electronic equipment (Elektro- und Elektronikgerätegesetz, ElektroG). WEEE marking: crossed-out wheeled bin with solid bar under. A significant part of the materials must be recycled in order to protect the environment.

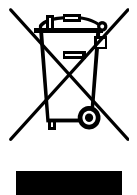



At the end of the device's service life, have the chamber disposed of according to the German national law for electrical and electronic equipment (Elektro- und Elektronikgerätegesetz, ElektroG from 20 October 2015, BGBl. I p. 1739) or contact BINDER service who will organize taking back and disposal of the chamber according to the German national law for electrical and electronic equipment (Elektro- und Elektronikgerätegesetz, ElektroG from 20 October 2015, BGBl. I p. 1739).

	NOTICE
	<p><b>Danger of violation against existing law if not disposed of properly.</b></p> <p><b>Failure to comply with applicable law.</b></p> <ul style="list-style-type: none"> <li>∅ Do NOT dispose of BINDER devices at public collecting points.</li> <li>➤ Have the device disposed of professionally at a recycling company, which is certified according to the German national law for electrical and electronic equipment (Elektro- und Elektronikgerätegesetz, ElektroG from 20 October 2015, BGBl. I p. 1739).</li> <li style="text-align: center;">or</li> <li>➤ Instruct BINDER Service to dispose of the device. The general terms of payment and delivery of BINDER GmbH apply, which were valid at the time of purchasing the chamber.</li> </ul>

Certified companies disassemble waste (used) BINDER equipment in primary substances for recycling according to Directive 2012/19/EU. The devices must be free from toxic, infectious or radioactive substances in order to eliminate any health hazards to the employees of the recycling companies.

	<p>Prior to handing the chamber over to a recycling company, it is the user's responsibility that it is free from toxic, infectious or radioactive substances.</p> <ul style="list-style-type: none"> <li>• Prior to disposal, clean all introduced or residual toxic substances from the chamber.</li> <li>• Prior to disposal, disinfect the chamber from all sources of infection. Be aware that sources of infection may also be located outside the inner chamber.</li> <li>• If you cannot safely remove all toxic substances and sources of infection from the chamber, dispose of it as special waste according to national law.</li> <li>• Fill out the contamination clearance certificate (chap. 28) and enclose it with the chamber.</li> </ul>
---	---

	 <b>WARNING</b>
	<p><b>Danger of intoxication and infection through contamination of the chamber with toxic, infectious or radioactive substances.</b></p> <p><b>Damages to health.</b></p> <ul style="list-style-type: none"> <li>∅ NEVER take a chamber contaminated with toxic substances or sources of infection for recycling according to Directive 2012/19/EU.</li> <li>➤ Prior to disposal, remove all toxic substances and sources of infection from the chamber.</li> <li>➤ A chamber from which all toxic substances or sources of infection cannot be safely removed must be considered as "special" waste according to national law. Dispose of it accordingly.</li> </ul>

## 25.4 Disposal of the chamber in the member states of the EU except for the Federal Republic of Germany

According to Annex I of Directive 2012/19/EU of the European Parliament and of the Council on waste electrical and electronic equipment (WEEE), BINDER devices are classified as "monitoring and control instruments" (category 9) only intended for professional use". They must not be disposed of at public collecting points.

The chambers bear the symbol for the marking of electrical and electronic equipment manufactured / placed on the market in the EU after 13 August 2005 and be disposed of in separate collection according to the Directive 2012/19/EU on waste electrical and electronic equipment (WEEE). WEEE marking: crossed-out wheeled bin with solid bar under.

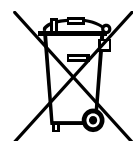



At the end of the device's service life, notify the distributor who sold you the device, who will take back and dispose of the chamber according to the Directive 2012/19/EU on waste electrical and electronic equipment (WEEE).



	NOTICE
	<p><b>Danger of violation against existing law if not disposed of properly.</b>  <b>Failure to comply with applicable law.</b></p> <ul style="list-style-type: none"> <li>∅ Do NOT dispose of BINDER devices at public collecting points.</li> <li>➤ Have the device disposed of professionally at a recycling company, which is certified according to conversion of the Directive 2012/19/EU into national law.</li> <li style="text-align: center;"><i>or</i></li> <li>➤ Instruct the distributor who sold you the device to dispose of it. The agreements apply that were agreed with the distributor when purchasing the chamber (e.g. his general terms of payment and delivery).</li> <li>➤ If your distributor is not able to take back and dispose of the chamber, please contact BINDER service.</li> </ul>

Certified companies disassemble waste (used) BINDER equipment in primary substances for recycling according to Directive 2012/19/EU. The devices must be free from toxic, infectious or radioactive substances in order to eliminate any health hazards to the employees of the recycling companies.

	<p>Prior to handing the chamber over to a recycling company, it is the user's responsibility that it is free from toxic, infectious or radioactive substances.</p> <ul style="list-style-type: none"> <li>• Prior to disposal, clean all introduced or residual toxic substances from the chamber.</li> <li>• Prior to disposal, disinfect the chamber from all sources of infection. Be aware that sources of infection may also be located outside the inner chamber.</li> <li>• If you cannot safely remove all sources of infection and toxic substances from the chamber, dispose of it as special waste according to national law.</li> <li>• Fill out the contamination clearance certificate (chap. 28) and enclose it with the chamber.</li> </ul>
---	---

	 <b>WARNING</b>
	<p><b>Danger of intoxication and infection through contamination of the chamber with toxic, infectious or radioactive substances.</b>  <b>Damages to health.</b></p> <ul style="list-style-type: none"> <li>∅ NEVER take a chamber contaminated with toxic substances or sources of infection for recycling according to Directive 2012/19/EU.</li> <li>➤ Prior to disposal, remove all toxic substances and sources of infection from the chamber.</li> <li>➤ A chamber from which all toxic substances or sources of infection cannot be safely removed must be considered as "special" waste according to national law. Dispose of it accordingly.</li> </ul>

## 25.5 Disposal of the chamber in non-member states of the EU

	NOTICE
	<p><b>Danger of violation against existing law if not disposed of properly.</b>  <b>Failure to comply with applicable law. Alteration of the environment.</b></p> <ul style="list-style-type: none"> <li>➤ For final decommissioning and disposal of the chamber, please contact BINDER service.</li> <li>➤ Follow the statutory regulations for appropriate, environmentally friendly disposal.</li> </ul>

## 26. Technical description

### 26.1 Factory calibration and adjustment

The chambers were calibrated and adjusted in the factory. Calibration and adjustment were performed using standardized test instructions, according to the QM DIN EN ISO 9001 system applied by BINDER (certified since December 1996 by TÜV CERT). All test equipment used is subject to the administration of measurement and test equipment that is also a constituent part of the BINDER QM DIN EN ISO 9001 systems. They are controlled and calibrated to a DKD-Standard at regular intervals.



Repeated calibrations are recommended in periods of 12 months.

### 26.2 Over current protection

The chambers are equipped with an internal fuse not accessible from outside. If this fuse is blown, please contact an electronic engineer or BINDER service.

### 26.3 Definition of usable volume

The usable volume illustrated below is calculated as follows:

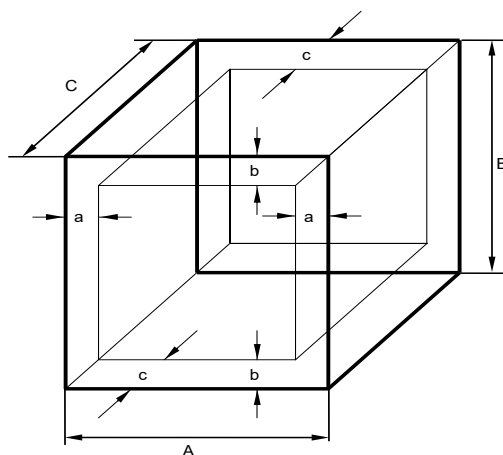

A, B, C = internal dimensions (W, H, D)

a, b, c = distance to wall

$$a = 0.1 \cdot A$$

$$b = 0.1 \cdot B$$

$$c = 0.1 \cdot C$$

$$V_{USE} = (A - 2 \cdot a) \cdot (B - 2 \cdot b) \cdot (C - 2 \cdot c)$$

Figure 8: Determination of the useable volume

The technical data refers to the defined usable volume.



Do NOT place samples outside this usable volume.

Do NOT load this volume by more than half to enable sufficient airflow inside the chamber.

Do NOT divide the usable volume into separate parts with large area samples.

Do NOT place samples too close to each other in order to permit circulation between them and thus obtain a homogenous distribution of temperature.

## 26.4 KB ECO / KB ECO-UL technical data

Chamber size		240	720	1020	
<b>Exterior dimensions</b>					
Width, gross (incl. access port)	mm / inch	932 / 36.69	1255 / 49.37	1254 / 49.37	
Height, gross (incl. feet/castors)	mm / inch	1461 / 57.52	1925 / 75.79	1925 / 75.79	
Depth, net	mm / inch	796 / 31.34	885 / 34.84	1149 / 45.24	
Depth, gross (including door handle, I-triangle, connection and 30 mm for cable)	mm / inch	921 / 36.26	1013 / 39.88	1277 / 50.28	
Wall clearance rear (minimum) (spacer)	mm / inch	100 / 3.94	100 / 3.94	100 / 3.94	
Wall clearance side (minimum)	mm / inch	180 / 7.09	180 / 7.09	180 / 7.09	
<b>Doors</b>					
Quantity of doors		1	2	2	
Quantity of glass doors		1	2	2	
<b>Interior dimensions</b>					
Width	mm / inch	650 / 25.60	970 / 38.19	970 / 38.19	
Height	mm / inch	785 / 30.91	1250 / 49.21	1250 / 49.21	
Depth	mm / inch	485 / 19.09	576 / 22.68	836 / 32.91	
Interior volume	l / cu.ft.	247 / 8.7	700 / 24.7	1020 / 36.0	
Steam space volume	l / cu.ft.	348 / 12.3	918 / 32.4	1280 / 45.2	
<b>Racks</b>					
Quantity of racks (regular)		2	2	2	
Quantity of racks (max.)		9	15	15	
Maximum load per rack	kg / lbs.	30 / 66	45 / 99	45 / 99	
Maximum permitted total load	kg / lbs.	100 / 220	150 / 331	150 / 331	
<b>Weight</b>					
Weight (empty)	kg / lbs.	152 / 335	272 / 600	327 / 721	
<b>Temperature data</b>					
Temperature range	from ... degrees below ambient temperature	°C / °F	28 / 50.4	26 / 46.8	26 / 46.8
	up to	°C / °F	70 / 158	70 / 158	70 / 158
Temperature fluctuation	at 25 °C / 77 °F	± K	0.1	0.1	0.1
	at 37 °C / 98.6 °F	± K	0.1	0.1	0.1
Temperature uniformity (variation)	at 25 °C / 77 °F	± K	0.1	0.1	0.1
	at 37 °C / 98.6 °F	± K	0.1	0.1	0.1
Recovery time after one door was open for 30 s	at 25 °C / 77 °F	minutes	1	1	1
	at 37 °C / 98.6 °F	minutes	4	4	3
Max. heat compensation	at 40 °C / 104 °F	W	350	500	500
<b>Electrical data</b> (model versions KBECO240-230V, KBECO720-230V, KBECO1020-230V)					
System of protection acc. to EN 60529		IP	20	20	20
Nominal voltage (+/-10%)	at 50 Hz power frequency	V	200-230	200-230	200-230
	at 60 Hz power frequency	V	200-230	200-230	200-230
Current type		1N~	1N~	1N~	1N~
Power plug		CEE 7/7 grounded plug			
Nominal power		kW	0.90	1.30	1.30
Installation category acc. to IEC 61010-1			II	II	II
Pollution degree acc. to IEC 61010-1			2	2	2
Over-current release category B, 2 poles		Amp	16 internal	16 internal	16 internal

Chamber size		240	720	1020	
<b>Different electrical data for KB ECO-UL</b> (model versions KBECO240UL-120V, KBECO720UL-120V, KBECO1020UL-120V)					
Nominal voltage (+/-10%)	at 50 Hz power frequency	V	100-120	100-120	100-120
	at 60 Hz power frequency	V	100-120	100-120	100-120
Current type			1N~	1N~	1N~
Power plug		NEMA	5-20P	5-20P	5-20P
<b>Environment-specific data</b>					
Noise level (mean value)	at 25 °C / 77 °F, equilibrated state	dB (A)	43	47	47
Energy consumption *	at 25 °C / 77 °F	Wh/h	45	75	75
	at 37 °C / 98.6 °F	Wh/h	65	105	105

\* Anti-condensation protection set to 0% intensity

All technical data is specified for unloaded chambers with standard equipment at an ambient temperature of +22 °C +/- 3°C / 71.6 °F +/- 5.4 °F and a power supply voltage fluctuation of +/-10%. Technical data is determined in accordance to BINDER Factory Standard Part 2:2015 and DIN 12880:2007.

**All indications are average values, typical for chambers produced in series. We reserve the right to change technical specifications at any time.**



If the chamber is fully loaded, the specified heating up and cooling down times may vary according to the load.

## 26.5 Equipment and options (extract)



To operate the chamber, use only original BINDER accessories or accessories / components from third-party suppliers authorized by BINDER. The user is responsible for any risk arising from using unauthorized accessories.

<b>Regular equipment</b>
RD4 microprocessor controller for temperature
Ethernet interface for computer communication
USB interface
Safety controller (temperature safety device class 3.1 acc. to DIN 12880:2007)
Peltier refrigerating system
Four castors (2 lockable)
Rack, stainless steel
Access port 30 mm with silicone plug
Additional rack, stainless steel

<b>Options / accessories</b>
Perforated shelf, stainless steel
Stable shelf with additional fixation for shaker operation
Reinforced shelf, max. load 45 kg
Reinforced rack with rack lockings
Securing elements for additional fastening of racks (4 pieces)
Lockable door
Access ports 30 mm or 50 mm or 100 mm top and/or right with silicone plug

Options / accessories
BINDER Data Logger kit T 220
Calibration of temperature and humidity including certificate
Spatial temperature measurement including certificate
Spatial temperature measurement acc. to DIN 12880:2007 including certificate
Qualification folder

## 26.6 Accessories and spare parts (extract)



BINDER GmbH is responsible for the safety features of the chamber only, provided skilled electricians or qualified personnel authorized by BINDER perform all maintenance and repair, and if components relating to chamber safety are replaced in the event of failure with original spare parts. The user is responsible for any risks arising from using unauthorized accessories/components.

Chamber size	240	720	1020
Description	Art. no.		
Rack, stainless steel	6004-0101	6004-0106	6004-0143
Perforated rack, stainless steel	6004-0040	8009-0486	8009-0792
Reinforced rack with rack lockings	8012-0638	8012-0674	8012-0968
Rack lockings (4 pieces)	8012-0620	8012-0620	8012-0620
Door gasket, silicone (kettle)	6005-0147	6005-0196	6005-0196
Door gasket, silicone (outer door)	6005-0161	6005-0197	6005-0197
Intermediate door gasket, silicone	---	6005-0250	6005-0250

Description	Art. no.
Plug for silicon access port d30	6016-0035
Data Logger Kit T 220	8012-0715
Data Logger Software	8012-0821
Neutral cleaning agent, 1 kg	1002-0016

For information on components not listed here, please contact BINDER Service.

Validation service	Art. no.
Qualification folder IQ-OQ (printed version)	7007-0001
Qualification folder IQ-OQ (digital version)	7057-0001
Qualification folder IQ-OQ-PQ (printed version)	7007-0005
Qualification folder IQ-OQ-PQ (digital version)	7057-0005
Execution of IQ-OQ	DL410200
Execution of IQ-OQ-PQ	DL440500

Calibration service	Art. no.
Calibration of temperature including certificate (1 measuring point)	DL300101
Spatial temperature measurement including certificate (9 measuring points)	DL300109
Spatial temperature measurement including certificate (18 measuring points)	DL300118
Spatial temperature measurement including certificate (27 measuring points)	DL300127

## 26.7 Dimensions

Dimensions size 240:

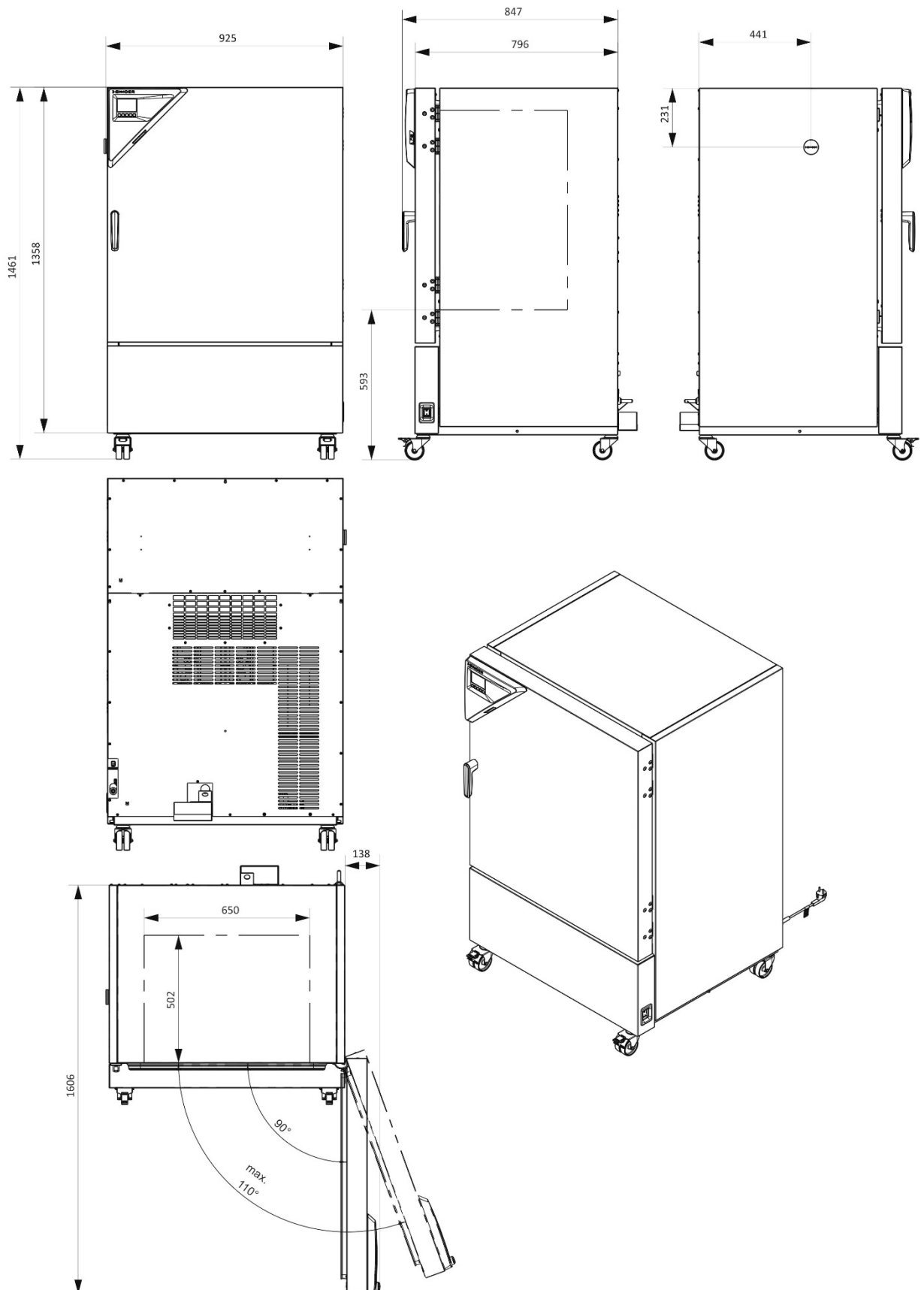

[mm]

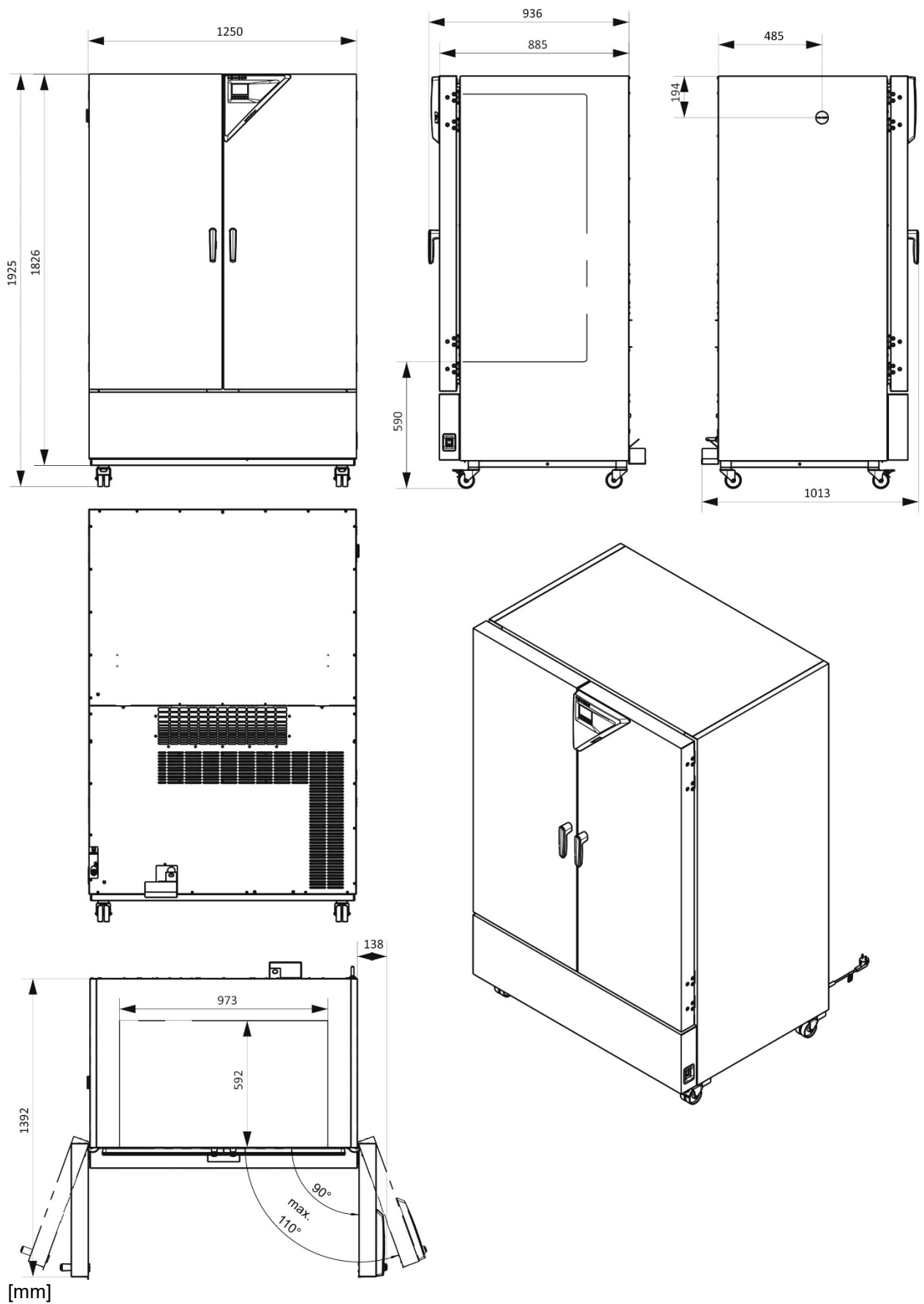

**Dimensions size 720:**

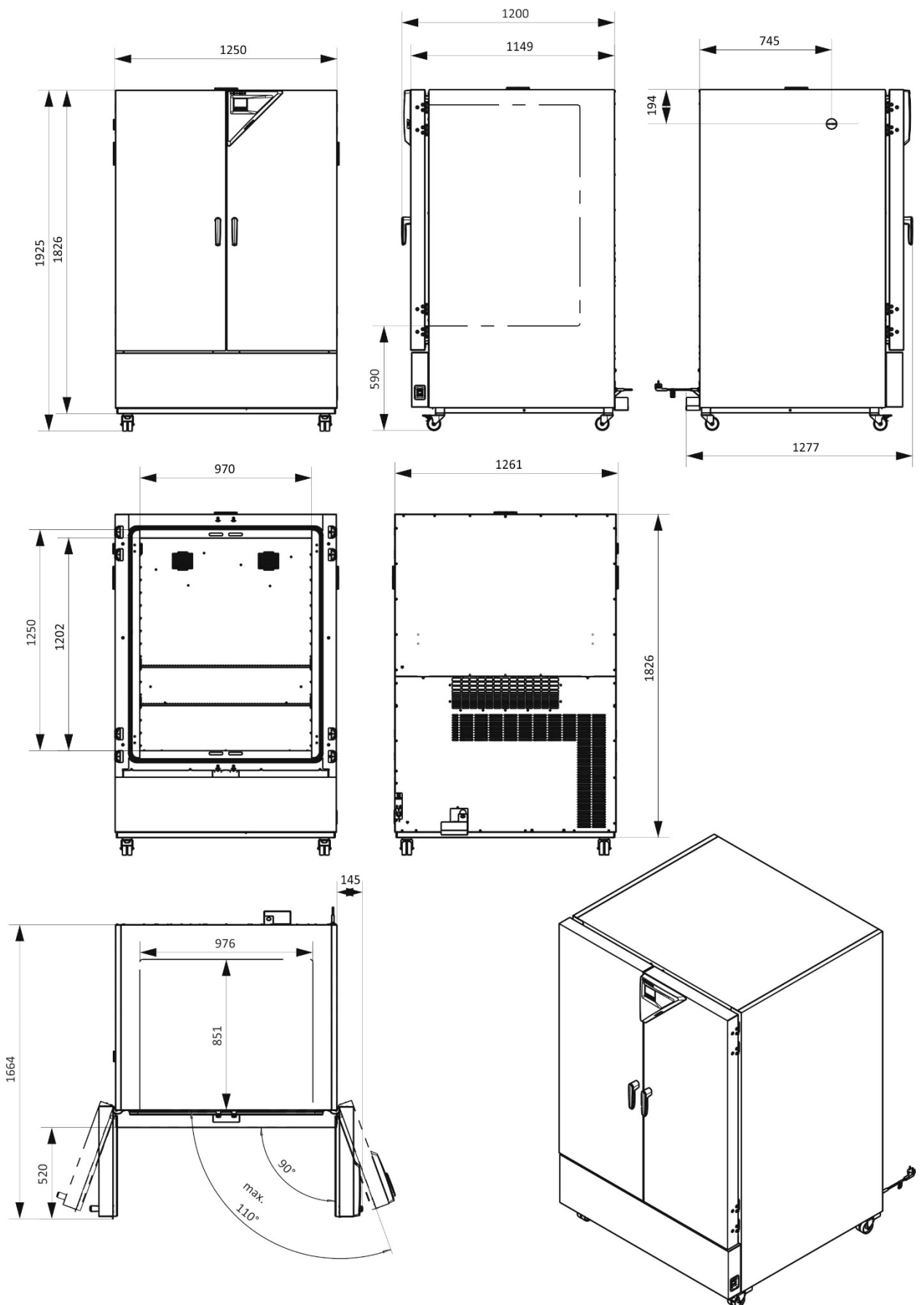
**Dimensions size 1020:**

[mm]

## 27. Certificates and declarations of conformity

### 27.1 EU Declaration of Conformity

**CE** EU-Konformitätserklärung / EU Declaration of Conformity / Déclaration de conformité UE / Declaración de conformidad UE / Dichiarazione di conformità UE / Декларация соответствия EU

Hersteller / Manufacturer / Fabricant / Fabricante / Fabbicante / Производитель	BINDER GmbH
Anschrift / Address / Adresse / Dirección / Indirizzo / Адрес	Im Mittleren Ösch 5, 78532 Tuttlingen, Germany
Produkt / Product / Produit / Producto / Prodotto / Продукт	Kühlinkubatoren mit Peltier-Technologie Cooling incubators with thermoelectric cooling Incubateurs réfrigérés avec technologie Peltier Incubadoras refrigeradas con tecnología Peltier Incubatori refrigerati con tecnologia Peltier Инкубаторы с охлаждением с технологией Peltier
Typenbezeichnung / Type / Type / Tipo / Tipo / Тип	KB ECO 240, KB ECO 720, KB ECO 1020 (E6.2)
Art. No. / Art. no. / Réf. / Art. N° / Art. n. / № арт.	9020-0423, 9120-0423, 9020-0426, 9120-0426 9020-0424, 9120-0424, 9020-0427, 9120-0427 9020-0425, 9120-0425, 9020-0428, 9120-0428

Die oben beschriebenen Maschinen sind konform mit folgenden EG/EU-Richtlinien (gemäß Veröffentlichung im Amtsblatt der europäischen Kommission):

The machines described above are in conformity with the following EC/EU Directives (as published in the Official Journal of the European Union):

Les machines décrites ci-dessus sont conformes aux directives CE/UE suivantes (selon leur publication dans le Journal officiel de l'Union européenne):

La máquina descrita arriba cumple con las siguientes directivas de la CE/UE (publicados en el Diario oficial de la Unión Europea):

Le macchine sopra descritte sono conforme alle seguenti direttive CE/UE (secondo la pubblicazione nella Gazzetta ufficiale della Commissione europea):

Машина, указанная выше, полностью соответствует следующим регламентам ЕС/ЕУ (опубликованным в Официальном журнале Европейского Содружества):

- **2006/42/EC**  
Maschinenrichtlinie 2006/42/EG / Machinery directive 2006/42/EC / Directive Machines 2006/42/EC / Directiva 2006/42/CE (Máquinas) / Direttiva macchine 2006/42/CE / Директива о машинах 2006/42/EC
- **2014/30/EU**  
EMV-Richtlinie 2014/30/EU / EMC Directive 2014/30/EU / Directive CEM 2014/30/UE / Directiva CEM 2014/30/UE / Direttiva EMC 2014/30/UE / Директива ЭМС 2014/30/EU
- **2011/65/EU, (EU) 2015/863**  
RoHS-Richtlinien 2011/65/EU und (EU) 2015/863 / RoHS Directives 2011/65/EU and (EU) 2015/863 / Directivas RoHS 2011/65/UE et (UE) 2015/863 / Direttive RoHS 2011/65/UE y (UE) 2015/863 / Direttive RoHS 2011/65/UE et (UE) 2015/863 / Директивы RoHS 2011/65/EU и (EU) 2015/863

1 / 3

BINDER GmbH Postfach 102 D-78502 Tuttlingen Anschrift: BINDER GmbH Im Mittleren Ösch 5 D-78532 Tuttlingen  
Kontakt: Telefon: +49 (0) 74 62 / 20 05 – 0 | Telefax: +49 (0) 74 62 / 20 05 – 100 | info@binder-world.com | www.binder-world.com  
Geschäftsführung: Dipl.-Ing. Peter M. Binder | Amtsgericht Stuttgart, HRB 727150 | Sitz der Gesellschaft: Tuttlingen  
Bankverbindung: Kreissparkasse Tuttlingen IBAN-Code: DE05643 500700 000002266 | SWIFT-Code: SOLA DE 31TUT  
Deutsche Bank Tuttlingen IBAN-Code: DE56653 70075 0213870900 | SWIFT-Code: DEUT DE 55653  
Altgeräte-Entsorgung gemäß WEEE-Reg.-Nr. DE 37004983

Die oben beschriebenen Maschinen entsprechen aufgrund ihrer Konzipierung und Bauart sowie in der von uns in Verkehr gebrachten Ausführung den einschlägigen grundlegenden Sicherheits- und Gesundheitsanforderungen der genannten EG/EU-Richtlinien.

The machines described above are conform to the mentioned EC/EU directives in regard to the relevant safety and health demands due to their conception and style of construction as well as to the version put onto market by us.

Les machines décrites ci-dessus correspondent aux demandes de sécurité et de santé des directives citées de la CE/UE due à leur conception et construction et dans la réalisation mise sur le marché par nous.

Las máquinas descritas arriba se corresponden con los requisitos básicos pertinentes de seguridad y salud de las citadas directivas de la CE/UE debido a su concepción y fabricación, así como a la realización llevada a cabo por nosotros.

Le macchine sopra descritte sono conforme ai requisiti essenziali di sanità e sicurezza pertinenti delle summenzionate direttive CE/UE in termini di progettazione, tipo di costruzione ed esecuzione messa da noi in circolazione.

Машины описано выше, соответствует указанным директивам ЕС/ЕУ в отношении требований соответствующей безопасности и здоровья по концепции и конструкции так же как и версия, применяемая нами на рынке.

Die oben beschriebenen Maschinen tragen entsprechend die Kennzeichnung CE.

The machines described above, corresponding to this, bear the CE-mark.

Les machines décrits ci-dessus, en correspondance, portent l'indication CE.

Las máquinas descritas arriba, en conformidad, llevan la indicación CE.

Le macchine sopra descritte sono contrassegnate dal marchio CE.

Машины описано выше, в соответствии с изложенным выше маркированы знаком CE.

Die oben beschriebenen Maschinen sind konform mit folgenden harmonisierten Normen:

The machines described above are in conformity with the following harmonized standards:

Les machines décrits ci-dessus sont conformes aux normes harmonisées suivantes:

Las máquinas descritas arriba cumplen con las siguientes normas:

Le macchine sopra descritte sono conforme alle seguenti normative armonizzate:

Машины описано выше, полностью соответствуют следующим стандартам:

Sicherheit / Safety / Sécurité / Seguridad / Sicurezza / Нормативы по безопасности

- **EN ISO 12100:2010 + Corr. 1:2011**
- **EN ISO 13732-1:2008**
- **EN 60204-1:2018**

EMV / EMC / CEM / CEM / EMC / ЭМС
• EN 61326-1:2013
RoHS
• EN IEC 63000:2018

78532 Tuttlingen, 29.11.2021  
BINDER GmbH



P. Wimmer  
Vice President  
Vice President  
Vice président  
Vicepresidente  
vicepresidente  
Вице-президент



J. Bollaender  
Leiter F & E  
Director R & D  
Chef de service R&D  
Responsable I & D  
Direttore R & D  
Глава департамента R&D

3 / 3

BINDER GmbH Postfach 102 D-78502 Tuttlingen Anschrift: BINDER GmbH Im Mittleren Ösch 5 D-78532 Tuttlingen  
Kontakt: Telefon: +49 (0) 74 62 / 20 05 – 0 | Telefax: +49 (0) 74 62 / 20 05 – 100 | info@binder-world.com | www.binder-world.com  
Geschäftsführung: Dipl.-Ing. Peter M. Binder | Amtsgericht Stuttgart, HRB 727150 | Sitz der Gesellschaft: Tuttlingen  
Bankverbindung: Kreissparkasse Tuttlingen IBAN-Code: DE05643 500700 000002266 | SWIFT-Code: SOLA DE S1TUT  
Deutsche Bank Tuttlingen IBAN-Code: DE56653 70075 0213870900 | SWIFT-Code: DEUT DE SS653  
Allgeräte-Entsorgung gemäß WEEE-Reg.-Nr. DE 37004983



## 27.2 Certificate for the GS mark of conformity of the “Deutsche Gesetzliche Unfallversicherung e.V.” (German Social Accident Insurance) DGUV

Zertifikat  
Nr. **NV 21135**  
vom 01.07.2021

 **DGUV Test**  
Prüf- und Zertifizierungsstelle  
Nahrungsmittel und Verpackung  
Fachbereich Nahrungsmittel

### GS-Zertifikat

Name und Anschrift des Zertifikatsinhabers: (Auftraggeber)	<b>Binder GmbH</b> Im Mittleren Ösch 5 78532 Tuttlingen
Produktbezeichnung:	<b>Klima- und Kühlbrutschrank</b>
Typ:	KB ECO 53, KB ECO 115, KB ECO 170, KB ECO 240, KB ECO 720, KB ECO 1020, KBF-S ECO 240, KBF-S ECO 720, KBF-S ECO 1020
Prüfgrundlage:	GS-NV 5:2019/08 Prüfgrundsätze für Kühl- und Gefriermaschinen für Industrie und Gewerbe
Zugehöriger Prüfbericht:	Prüfbericht zum Zertifikat NV 21135
Weitere Angaben:	Das Zertifikat bezieht sich auf die im zugehörigen Prüfbericht be- schriebene Ausführung des Produkts.

Das geprüfte Baumuster stimmt mit den in § 21 Absatz 1 des Produktsicherheitsgesetzes genannten Anforderungen überein. Der Zertifikatsinhaber ist berechtigt, das umseitig abgebildete GS-Zeichen an den mit dem geprüften Baumuster übereinstimmenden Produkten anzubringen. Der Zertifikatsinhaber hat dabei die umseitig aufgeführten Bedingungen zu beachten.

Dieses Zertifikat einschließlich der Berechtigung zur Anbringung des GS-Zeichens ist gültig bis einschließlich:

**30.06.2026**

Weiteres über die Gültigkeit, eine Gültigkeitsverlängerung und andere Bedingungen regelt die Prüf- und Zertifizierungsordnung.



Rückseite GS-Zertifikat: NV 21135

### GS-Zeichen



Normalausführung



Bei einer Höhe von 20 mm oder weniger  
auch zulässige Ausführung

1. Der Zertifikatsinhaber hat die Voraussetzungen einzuhalten, die bei der Herstellung des umseitig genannten Produktes zu beachten sind, um die Übereinstimmung mit dem geprüften Baumuster zu gewährleisten.
2. Die Prüf- und Zertifizierungsstelle des Fachbereichs Nahrungsmittel führt in regelmäßigen Abständen Kontrollmaßnahmen zur Überwachung der Herstellung und rechtmäßigen Verwendung des GS-Zeichens durch.
3. Die für die Herstellung verantwortliche Person hat sich zur Einhaltung der Voraussetzungen nach Nummer 1 und Duldung der Kontrollmaßnahmen verpflichtet.
4. Die Prüf- und Zertifizierungsstelle entzieht dem Zertifikatsinhaber die Zuerkennung des GS-Zeichens, wenn sich die Anforderungen nach § 21 Absatz 1 Produktsicherheitsgesetz geändert haben oder die Voraussetzungen nach Nummer 1 nicht eingehalten werden.
5. Das GS-Zeichen darf nur verwendet und mit ihm darf nur geworben werden, wenn die Voraussetzungen nach § 22 Produktsicherheitsgesetz erfüllt sind.

## 28. Contamination clearance certificate

### 28.1 For chambers located outside USA and Canada

#### Declaration regarding safety and health

Erklärung zur Sicherheit und gesundheitlichen Unbedenklichkeit

The German Ordinance on Hazardous Substances (GefStofV), and the regulations regarding safety at the workplace, require that this form be filled out for all products that are returned to us, so that the safety and the health of our employees can be guaranteed

Die Sicherheit und Gesundheit unserer Mitarbeiter, die Gefahrstoffverordnung GefStofV und die Vorschriften zur Sicherheit am Arbeitsplatz machen es erforderlich, dass dieses Formblatt für alle Produkte, die an uns zurückgeschickt werden, ausgefüllt wird.



Note: A repair is not possible without a completely filled out form.

Ohne Vorliegen des vollständig ausgefüllten Formblattes ist eine Reparatur nicht möglich.

- A completely filled out form must be transmitted via Fax (+49 (0) 7462 2005 93555) or by letter in advance, so that this information is available before the equipment/component part arrives. A second copy of this form must accompany the equipment/component part. In addition, the carrier should be notified.

Eine vollständig ausgefüllte Kopie dieses Formblattes soll per Fax unter Nr. +49 (0) 7462 2005 93555 oder Brief vorab an uns gesandt werden, so dass die Information vorliegt, bevor das Gerät/Bauteil eintrifft. Eine weitere Kopie soll dem Gerät/Bauteil beigelegt sein. Ggf. ist die Spedition zu informieren.

- Incomplete information or non-conformity with this procedure will inevitably lead to substantial delays in processing. Please understand the reason for this measure, which lies outside our area of influence, and will help us to speed up this procedure.

Unvollständige Angaben oder Nichteinhalten dieses Ablaufs führen zwangsläufig zu beträchtlichen Verzögerungen in der Abwicklung. Bitte haben Sie Verständnis für Maßnahmen, die außerhalb unserer Einflussmöglichkeiten liegen und helfen Sie mit, den Ablauf zu beschleunigen.

- **Please print and fill out this form completely**

Bitte unbedingt vollständig ausfüllen!

<b>1.</b>	<b>Unit/ component part / type</b> / Gerät / Bauteil / Typ:
<b>2.</b>	<b>Serial No. / Serien-Nr.:</b>
<b>3.</b>	<b>Details about utilized substances / biological substances</b> / Einzelheiten über die eingesetzten Substanzen/biologische Materialien:
<b>3.1</b>	<b>Designations</b> / Bezeichnungen:
a)	_____
b)	_____
c)	_____
<b>3.2</b>	<b>Safety measures required for handling these substances</b> / Vorsichtsmaßnahmen beim Umgang mit diesen Stoffen:
a)	_____
b)	_____
c)	_____



<b>3.3 Measures to be taken in case of skin contact or release into the atmosphere / Maßnahmen bei Personenkontakt oder Freisetzung:</b>
a) _____
b) _____
c) _____
d) _____
<b>3.4 Other important information that must be taken into account / Weitere zu beachtende und wichtige Informationen:</b>
a) _____
b) _____
c) _____
<b>4. Declaration on the risk of these substances (please checkmark the applicable items) / Erklärung zur Gefährlichkeit der Stoffe (bitte Zutreffendes ankreuzen):</b>
<input type="checkbox"/> <b>4.1 For non toxic, non radioactive, biologically harmless materials / für nicht giftige, nicht radioaktive, biologisch ungefährliche Stoffe:</b> <b>We hereby guarantee that the above-mentioned unit / component part... / Wir versichern, dass o.g. Gerät/Bauteil...</b>
<input type="checkbox"/> Has not been exposed to or contains any toxic or otherwise hazardous substances / weder giftige noch sonstige gefährliche Stoffe enthält oder solche anhaften.
<input type="checkbox"/> That eventually generated reaction products are non-toxic and also do not represent a hazard / auch evtl. entstandene Reaktionsprodukte weder giftig sind noch sonst eine Gefährdung darstellen.
<input type="checkbox"/> Eventual residues of hazardous substances have been removed / evtl. Rückstände von Gefahrstoffen entfernt wurden.
<input type="checkbox"/> <b>4.2 For toxic, radioactive, biologically harmful or hazardous substances, or any other hazardous materials / für giftige, radioaktive, biologisch bedenkliche bzw. gefährliche Stoffe oder anderweitig gefährliche Stoffe.</b> <b>We hereby guarantee that ... / Wir versichern, dass ...</b>
<input type="checkbox"/> The hazardous substances, which have come into contact with the above-mentioned equipment / component part, have been completely listed under item 3.1 and that all information in this regard is complete / die gefährlichen Stoffe, die mit dem o.g. Gerät/Bauteil in Kontakt kamen, in 3.1 aufgelistet sind und alle Angaben vollständig sind.
<input type="checkbox"/> That the unit /component part has not been in contact with radioactivity / das Gerät/Bauteil nicht mit Radioaktivität in Berührung kam
<b>5. Kind of transport / transporter / Transportweg/Spediteur:</b>
Transport by (means and name of transport company, etc.) Versendung durch (Name Spediteur o.ä.) _____
Date of dispatch to BINDER GmbH / Tag der Absendung an BINDER GmbH: _____

**We hereby declare that the following measures have been taken / Wir erklären, dass folgende Maßnahmen getroffen wurden:**

- Hazardous substances were removed from the unit including component parts, so that no hazard exists for any person in the handling or repair of these items / das Gerät/Bauteil wurde von Gefahrstoffen befreit, so dass bei Handhabung/Reparaturen für die betreffenden Person keinerlei Gefährdung besteht
- The unit was securely packaged and properly identified / das Gerät wurde sicher verpackt und vollständig gekennzeichnet.
- Information about the hazardousness of the shipment (if required) has been provided to the transporter / der Spediteur wurde (falls vorgeschrieben) über die Gefährlichkeit der Sendung informiert.

We hereby commit ourselves and guarantee that we will indemnify BINDER GmbH for all damages that are a consequence of incomplete or incorrect information provided by us, and that we will exempt BINDER GmbH from eventual damage claims by third parties / Wir versichern, dass wir gegenüber BINDER für jeden Schaden, der durch unvollständige und unrichtige Angaben entsteht, haften und BINDER gegen eventuell entstehende Schadensansprüche Dritter freistellen.

We are aware that, in accordance with Article 823 of the German Civil Code (BGB), we are directly liable with regard to third parties, in this instance especially the employees of BINDER GmbH, who have been entrusted with the handling / repair of the unit / component. / Es ist uns bekannt, dass wir gegenüber Dritten – hier insbesondere With the Handhabung/Reparatur des Geräts/des Bauteils betraute Mitarbeiter der Firma BINDER - gemäß §823 BGB direkt haften

Name: \_\_\_\_\_

Position/ Title: \_\_\_\_\_

Date / Datum: \_\_\_\_\_

Signature / Unterschrift: \_\_\_\_\_

Company stamp / Firmenstempel:



Equipment that is returned to the factory for repair must be accompanied by a completely filled out contamination clearance certificate. For service and maintenance on site, such a contamination clearance certificate must be submitted to the service technician before the start of any work. No repair or maintenance of the equipment is possible, without a properly filled out contamination clearance certificate.

## 28.2 For chambers located in USA and Canada

### Product Return Authorization Request

Please complete this form and the Customer Decontamination Declaration (next 2 pages) and attach the required pictures. E-mail to: IDL\_SalesOrderProcessing\_USA@binder-world.com

After we have received and reviewed the complete information we will decide on the issue of a RMA number. Please be aware that size specifications, voltage specifications as well as performance specifications are available on the internet at [www.binder-world.us](http://www.binder-world.us) at any time.

Take notice of shipping laws and regulations.

	Please fill:	
Reason for return request	<input type="radio"/> Duplicate order	
	<input type="radio"/> Duplicate shipment	
	<input type="radio"/> Demo	<i>Page one completed by sales</i>
	<input type="radio"/> Power Plug / Voltage	115V / 230 V / 208 V / 240V
	<input type="radio"/> Size does not fit space	
	<input type="radio"/> Transport Damage	Shock watch tripped? ( <i>pictures</i> )
	<input type="radio"/> Other (specify below)	
	_____	
Is there a replacement PO?	<input type="radio"/> Yes <input type="radio"/> No	
<i>If yes -&gt; PO #</i>		
<i>If yes -&gt; Date PO placed</i>		
Purchase order number		
BINDER model number		
BINDER serial number		
Date unit was received		
Was the unit unboxed?	<input type="radio"/> Yes <input type="radio"/> No	
Was the unit plugged in?	<input type="radio"/> Yes <input type="radio"/> No	
Was the unit in operation?	<input type="radio"/> Yes <input type="radio"/> No	
<i>Pictures of unit attached?</i>	<input type="radio"/> Yes <input type="radio"/> No	Pictures have to be attached!
<i>Pictures of Packaging attached?</i>	<input type="radio"/> Yes <input type="radio"/> No	

	Customer Contact Information	Distributor Contact Information
Name		
Company		
Address		
Phone		
E-mail		

## Customer (End User) Decontamination Declaration

### Health and Hazard Safety declaration

To protect the health of our employees and the safety at the workplace, we require that this form is completed by the user for all products and parts that are returned to us. (Distributors or Service Organizations cannot sign this form)



NO RMA number will be issued without a completed form. Products or parts returned to our NY warehouse without an RMA number will be refused at the dock.

A second copy of the completed form must be attached to the outside of the shipping box.

<b>1.</b>	<b>Unit/ component part / type:</b>
<b>2.</b>	<b>Serial No.</b>
<b>3.</b>	<b>List any exposure to hazardous liquids, gasses or substances and radioactive material</b>
<b>3.1</b>	<b>List with MSDS sheets attached where available or needed (if there is not enough space available below, please attach a page):</b>
a)	_____
b)	_____
c)	_____
<b>3.2</b>	<b>Safety measures required for handling the list under 3.1</b>
a)	_____
b)	_____
c)	_____
<b>3.3</b>	<b>Measures to be taken in case of skin contact or release into the atmosphere:</b>
a)	_____
b)	_____
c)	_____
d)	_____
<b>3.4</b>	<b>Other important information that must be considered:</b>
a)	_____
b)	_____
c)	_____

**4. Declaration of Decontamination**

**For toxic, radioactive, biologically and chemically harmful or hazardous substances, or any other hazardous materials.**

**We hereby guarantee that**

- 4.1 Any hazardous substances, which have come into contact with the above-mentioned equipment / component part, have been completely listed under item 3.1 and that all information in this regard is complete.
- 4.2 That the unit /component part has not been in contact with radioactivity
- 4.3 Any Hazardous substances were removed from the unit / component part, so that no hazard exists for a person in the shipping, handling or repair of these returned unit
- 4.4 The unit was securely packaged in the original undamaged packaging and properly identified on the outside of the packaging material with the unit designation, the RMA number and a copy of this declaration.
- 4.5 Shipping laws and regulations have not been violated.

**I hereby commit and guarantee that we will indemnify BINDER Inc. for all damages that are a consequence of incomplete or incorrect information provided by us, and that we will indemnify and hold harmless BINDER Inc. from eventual damage claims by third parties.**

Name: \_\_\_\_\_

Position: \_\_\_\_\_

Company: \_\_\_\_\_

Address: \_\_\_\_\_

Phone #: \_\_\_\_\_

Email: \_\_\_\_\_

Date: \_\_\_\_\_

Signature: \_\_\_\_\_



Equipment returned to the NY warehouse for repair must be accompanied by a completed customer decontamination declaration. For service and maintenance works on site, such a customer decontamination declaration must be submitted to the service technician before the start of work. No repair or maintenance of the equipment is possible without a completed form.